

ΠΑΝΕΠΙΣΤΗΜΙΟ ΘΕΣΣΑΛΙΑΣ

ΣΧΟΛΗ ΕΠΙΣΤΗΜΩΝ ΥΓΕΙΑΣ
ΤΜΗΜΑ ΚΤΗΝΙΑΤΡΙΚΗΣ

ΜΕΛΕΤΗ ΤΗΣ ΛΟΧΕΙΑΣ ΣΕ ΘΗΛΥΚΟΥΣ ΣΚΥΛΟΥΣ ΦΥΛΗΣ BEAGLE

ΔΙΟΝΥΣΙΑ Κ. ΟΡΦΑΝΟΥ

Κτηνίατρος

ΔΙΔΑΚΤΟΡΙΚΗ ΔΙΑΤΡΙΒΗ

που εκπονήθηκε στην Κλινική Μαιευτικής και Αναπαραγωγής
του Τμήματος Κτηνιατρικής του Πανεπιστημίου Θεσσαλίας

Καρδίτσα 2012

Ἡ Ἰθάκη σ' ἔδωσε τ' ὄραϊο ταξεῖδι.
Χωρίς αὐτήν δὲν θ' ἄβγαινες στὸν δρόμο.
Ἄλλα δὲν ἔχει νὰ σὲ δώση πιά.
Κι ἂν πτωχικὴ τὴν βρῆς, ἡ Ἰθάκη δὲν σὲ γέλασε.
Ἔτσι σοφὸς ποὺ ἔγινες, μὲ τὸση πείρα,
ἤδη θὰ τὸ κατάλαβες ἡ Ἰθάκες τί σημαίνουν.

Κ.Π. Καβάφης (1911)

Ἡ διατριβή είναι αφιερωμένη στην οικογένειά μου

ΠΕΡΙΛΗΨΗ

Η παρούσα διατριβή εστιάζει στη μελέτη της λοχείας σε υγιείς, πρωτοτόκους, θηλυκούς σκύλους, εν γένει αποσκοπώντας στη βελτίωση της διαθέσιμης γνώσης σχετικά με τη διαδικασία της λοχείας σε αυτό το ζωικό είδος. Ειδικότερα, η παρούσα διατριβή αποσκοπεί: (α) στην αξιολόγηση τιμών 'αναφοράς' για αιματολογικές και βιοχημικές παραμέτρους κατά τη διάρκεια της λοχείας, (β) στην περιγραφή των χαρακτηριστικών της μήτρας και των μαστικών αδένων και των προοδευτικών μεταβολών αυτών κατά τη διάρκεια της λοχείας, (γ) στην ταυτοποίηση των χρονικών περιόδων, κατά τη διάρκεια των οποίων η μήτρα και οι μαστικοί αδένες είναι περισσότερο επιρρεπείς σε λοιμώξεις, (δ) στην ταυτοποίηση των κυττάρων που βρίσκονται στο περιεχόμενο της μήτρας και στο γάλα και (ν) στη μελέτη της συμπεριφοράς θηλασμού κατά τη διάρκεια της γαλακτικής περιόδου και τη διαπίστωση ενδεχόμενης συσχέτισης με τις λοιμώξεις του μαστού.

Αρχικά (1ο Κεφάλαιο), γίνεται ανασκόπηση της σχετικής βιβλιογραφίας. Το Κεφάλαιο χωρίζεται σε τρία Μέρη. Στο Μέρος Α, ανασκοπείται με συντομία η βιβλιογραφία που αφορά στην ανατομία του αναπαραγωγικού συστήματος και στη φυσιολογία της λοχείας στους θηλυκούς σκύλους. Στο Μέρος Β, ανασκοπείται η βιβλιογραφία που αφορά σε παθολογικές καταστάσεις στη διάρκεια της λοχείας στους θηλυκούς σκύλους (συστηματικές παθολογικές καταστάσεις, παθολογικές καταστάσεις της μήτρας, παθολογικές καταστάσεις των μαστικών αδένων). Στο Μέρος Γ, περιγράφεται η τεχνική της ωθηκυστερεκτομής κατά τη διάρκεια της λοχείας.

Τα Υλικά και οι μέθοδοι περιγράφονται με λεπτομέρεια στο 2ο Κεφάλαιο. Συνολικά, στη μελέτη χρησιμοποιήθηκαν 12 πρωτοτόκοι θηλυκοί σκύλοι φυλής Beagle. Όλα τα ζώα γέννησαν φυσιολογικά. Ακολούθησε η παρακολούθηση των ζώων μέχρι την 84η ημέρα μετά τον τοκετό. Πραγματοποιήθηκαν οι ακόλουθες εξετάσεις: (α) γενική κλινική εξέταση των ζώων (θηλυκοί σκύλοι και νεογέννητα), (β) κλινική εξέταση του γεννητικού συστήματος, (γ) υπερηχοτομογραφική εξέταση της μήτρας, (δ) κλινική εξέταση των μαστικών αδένων, (ε) υπερηχοτομογραφική εξέταση των μαστικών αδένων, (στ) προσδιορισμός αιματολογικών παραμέτρων και βιοχημικών παραμέτρων στον ορό του αίματος, (ζ) προσδιορισμός της συγκέντρωσης της προγεστερόνης στον ορό του αίματος, (η) βακτηριολογική και κυτταρολογική εξέταση δειγμάτων κολπικού εκκρίματος, (θ) βακτηριολογική και κυτταρολογική εξέταση δειγμάτων υλικού θηλαίου πόρου και γάλακτος και (ι) παρατηρήσεις συμπεριφοράς θηλασμού. Σε διαδοχικά χρονικά σημεία μετά τον τοκετό (4η, 7η, 10η, 14η, 21η, 28η, 35η, 42η, 56η, 70η και 84η ημέρα), πραγματοποιήθηκε ωθηκυστερεκτομή και μερική μαστεκτομή των ζώων, για συλλογή δειγμάτων ιστών για εξέταση. Πραγματοποιήθηκαν οι

ακόλουθες εξετάσεις: (α) μακροσκοπική εξέταση της μήτρας και των ωοθηκών, (β) βακτηριολογική και κυτταρολογική εξέταση δειγμάτων περιεχομένου της μήτρας, (γ) ιστολογική εξέταση, ιστομετρική εξέταση και εξέταση με ηλεκτρονικό μικροσκόπιο σάρωσης σε δείγματα ιστού μήτρας, (δ) βακτηριολογική εξέταση δειγμάτων μαστικού παρεγχύματος και (ε) ιστολογική εξέταση, ιστομετρική εξέταση και εξέταση με ηλεκτρονικό μικροσκόπιο σάρωσης δειγμάτων ιστού μαστικού παρεγχύματος. Για τις παραπάνω εξετάσεις, χρησιμοποιήθηκαν καθιερωμένες κλινικές, παρακλινικές, εργαστηριακές, ηθολογικές και στατιστικές τεχνικές. Για την αποτελεσματικότερη ανάλυση των αποτελεσμάτων, η λοχεία διαιρέθηκε σε τέσσερις περιόδους: L1 όπου περιλαμβάνονταν δείγματα που συλλέχθηκαν από την ημέρα D0 (ημέρα τοκετού) έως την ημέρα D7 (7 ημέρες μετά τον τοκετό) (n=59), L2 όπου περιλαμβάνονταν δείγματα που συλλέχθηκαν από την ημέρα D8 έως την ημέρα D21 (n=27), L3 όπου περιλαμβάνονταν δείγματα που συλλέχθηκαν από την ημέρα D22 έως την ημέρα D42 (n=18) και L4 όπου περιλαμβάνονταν δείγματα που συλλέχθηκαν από την ημέρα D43 έως την ημέρα D84 (n=18). Ειδικά για τη μελέτη των αιματολογικών παραμέτρων και των βιοχημικών παραμέτρων στον ορό του αίματος, λήφθηκαν υπόψη και δεδομένα σε όλη τη διάρκεια της εγκυμοσύνης των ζώων.

Τα αποτελέσματα της μελέτης παρουσιάζονται στο 3ο Κεφάλαιο και παρουσιάζονται περιληπτικά παρακάτω.

- Όλα τα ζώα ήταν κλινικώς υγιή στη διάρκεια της μελέτης.
- Παρατηρήθηκε σημαντική επίδραση της περί τον τοκετό περιόδου (τελευταία εβδομάδα της εγκυμοσύνης και πρώτη εβδομάδα της λοχείας) στις ακόλουθες αιματολογικές παραμέτρους και βιοχημικές παραμέτρους στον ορό του αίματος, για τις οποίες προτείνονται νέα όρια 'αναφοράς' κατά την παραπάνω περίοδο: αιματοκρίτης 24,1-35,3%, συνολικός αριθμός λευκοκυττάρων 13.200-31.400 κύτταρα μL^{-1} , αριθμός θρομβοκυττάρων 502.000-912.000 κύτταρα μL^{-1} , συγκέντρωση αιμοσφαιρίνης 7,7-10,6 g dL^{-1} , αριθμός ώριμων ουδετερόφιλων λευκοκυττάρων 8.500-25.200 κύτταρα μL^{-1} , συνολικός αριθμός λεμφοκυττάρων 2.200-7.500 κύτταρα μL^{-1} , συγκέντρωση ολικών πρωτεϊνών 4,3-6,4 g dL^{-1} , συγκέντρωση αλβουμίνης 1,7-2,6 g dL^{-1} και συγκέντρωση C-αντιδρώσας πρωτεΐνης 30,0-180,0 mg L^{-1} . Άλλες παράμετροι (δραστηριότητα αλκαλικής φωσφατάσης, συγκέντρωση ιοντισμένου ασβεστίου, συγκέντρωση ολικού ασβεστίου) μεταβλήθηκαν σημαντικά κατά την περί τον τοκετό περίοδο, αλλά οι τιμές αυτών παρέμειναν εντός των καθιερωμένων ορίων 'αναφοράς'. Τέλος, στις άλλες παραμέτρους που μελετήθηκαν (μέση συγκέντρωση αιμοσφαιρίνης στα ερυθροκύτταρα, συγκέντρωση ινωδογόνου, αναλογία ώριμων ουδετερόφιλων λευκοκυττάρων, αριθμός και αναλογία άωρων ουδετερόφιλων λευκοκυττάρων, αναλογία λεμφοκυττάρων, αριθμός και αναλογία μονοκυττάρων, εοσινόφιλων λευκοκυττάρων και βασεόφιλων λευκοκυττάρων,

συγκέντρωση σφαιρινών, συγκέντρωση γλυκόζης, συγκέντρωση μαγνησίου) δεν παρατηρήθηκαν σημαντικές μεταβολές κατά τη διάρκεια της παραπάνω περιόδου.

- Η διάμεση τιμή της συγκέντρωσης προγεστερόνης στο αίμα ήταν $0,43 \text{ ng mL}^{-1}$. Η διάμεση τιμή της κατά τις περιόδους [L1+L2] ήταν σημαντικά μεγαλύτερη από τη διάμεση τιμή της κατά τις περιόδους [L3+L4] ($0,48 \text{ ng mL}^{-1}$ και $0,32 \text{ ng mL}^{-1}$, αντίστοιχα, $P=0,013$).
- Παρατηρήθηκε κολπικό έκκριμα στο 58% των δειγματοληψιών. Το έκκριμα παρατηρήθηκε σε ελάχιστη έως μικρή ποσότητα, συνεχόμενα μέχρι την ημέρα D21 και, στη συνέχεια, με διαλείπουσα εμφάνιση μέχρι την ημέρα D77. Η διάμεση τιμή της διαμέτρου του σώματος της μήτρας, όπως εκτιμήθηκε με ψηλάφηση διαμέσου των κοιλιακών τοιχωμάτων, υπολογίστηκε σε $\sim 3.0 \text{ cm}$ την ημέρα D0 και σε $< 1.0 \text{ cm}$ την ημέρα D28 και στη συνέχεια ($P=0.01$). Η διάμεση τιμή των διαστάσεων του αιδοίου κατά τη διάρκεια της λοχείας ήταν: συνολικό πλάτος \times συνολικό ύψος = $2,7 \text{ cm} \times 3,4 \text{ cm}$ - η διάμεση τιμή της απόστασης από τον πρωκτό μέχρι το άνω άκρο του αιδοίου ήταν $8,0 \text{ cm}$. Οι διαστάσεις των εξωτερικών γεννητικών οργάνων των ζώων μειώθηκαν σταδιακά κατά τη διάρκεια της μελέτης.
- Στην υπερηχογραφική εξέταση, η μήτρα απεικονιζόταν, έως την ημέρα D21, ως ετερογενής σχηματισμός, ο οποίος αναγνωριζόταν με ευκολία, η δε διάμετρος των κεράτων αυτής εκτιμήθηκε ότι ήταν μεγαλύτερη από $1,0 \text{ cm}$. Προοδευτικά, η απεικόνιση της μήτρας γινόταν πιο δύσκολη και, την ημέρα D70, η διάμετρος των κεράτων αυτής εκτιμήθηκε σε $0,6$ έως $0,7 \text{ cm}$ ($P<0.001$). Σε εικόνες με επιμήκεις λήψεις, η μήτρα απεικονιζόταν σταθερά με κυλινδρικό σχήμα. Σε εικόνες με εγκάρσιες λήψεις έως την ημέρα D21, η μήτρα απεικονιζόταν με μορφή πολυγωνική έως συμπιεσμένη κυκλωτερή έως κυκλική. Σε εγκάρσιες λήψεις μετά την ημέρα D21, η μήτρα απεικονιζόταν με μορφή κυκλική. Διαπιστώθηκε η παρουσία ενός υποηχογενούς δακτυλίου, στο εσωτερικό του οποίου απεικονιζόταν μία περισσότερο ηχογενής δομή. Ο αυλός της μήτρας ήταν δύσκολα ορατός εξαιτίας του ηχογενούς περιεχομένου ή είχε έντονη αντίθεση με το υπερηχογενές ενδομήτριο. Οι θέσεις πρόσφυσης των εμβρυϊκών υμένων απεικονίζονταν ως κοκκώδεις σχηματισμοί με μέτρια ηχογένεια και μικρές ανηχογενείς περιοχές. Αρχικά, το τοίχωμα της μήτρας απεικονιζόταν ως σχηματισμός με πολλαπλές στιβάδες, αλλά, στη συνέχεια, ο αριθμός των ορατών στιβάδων μειωνόταν. Το πάχος του μυομητρίου και του ενδομητρίου, όπως και η διάμετρος του αυλού των κεράτων της μήτρας σταδιακά μειωνόταν με την εξέλιξη της λοχείας ($P<0.001$ και $P=0,003$, αντίστοιχα).
- Συνολικά, απομονώθηκαν βακτήρια σε 51 από τα 122 δείγματα κολπικού εκκρίματος που εξετάστηκαν βακτηριολογικά. Η συχνότητα απομόνωσης βακτηρίων σε δείγματα από τον κόλπο ήταν 52,5% κατά την περίοδο L1, 33,3% κατά τη διάρκεια την περίοδο L2, 33,3% κατά την περίοδο L3 και 27,8% κατά την περίοδο L4 ($P=0,094$). Η διάμεση τιμή της περιόδου από

τον τοκετό μέχρι την πρώτη μόλυνση της μήτρας ήταν 0,25 ημέρες. Η εκτιμώμενη διάμεση διάρκεια της λοίμωξης ήταν 5,25 ημέρες. Οι μικροοργανισμοί που απομονώθηκαν συχνότερα, ήταν *Escherichia coli* και *Trueperella (Arcanobacterium) pyogenes*: 22 και 16 στελέχη, αντίστοιχα, από τα 55 στελέχη που απομονώθηκαν συνολικά.

- Σε επιχρίσματα από το πρόσθιο τμήμα του κόλπου, η πλειονότητα των κυττάρων που παρατηρήθηκαν ήταν επιθηλιακά κύτταρα. Τα επιθηλιακά κύτταρα της μήτρας, φυσιολογικά ή εκφυλισμένα, παρατηρήθηκαν με χαρακτηριστική διάταξη σε συσσωματώματα. Τα επιθηλιακά κύτταρα κόλπου που παρατηρήθηκαν, ήταν κυρίως παραβασικά κύτταρα ή μικρά ενδιάμεσα κύτταρα. Παρατηρήθηκαν επίσης λευκοκύτταρα, μεταξύ των οποίων κυριαρχούσαν τα ουδετερόφιλα λευκοκύτταρα. Κατά τις περιόδους L1 και L2, παρατηρήθηκαν επίσης κύτταρα τύπου τροφοβλάστης. Κατά τη διάρκεια της μελέτης, παρατηρήθηκε σταδιακή αύξηση στον αριθμό των επιθηλιακών κυττάρων και σταδιακή μείωση στον αριθμό των λευκοκυττάρων ($P<0,04$). Σε δείγματα από τα οποία είχαν απομονωθεί βακτήρια, υπήρχε σημαντικά μεγαλύτερος λευκοκυττάρων ($P=0.045$), αλλά όχι επιθηλιακών κυττάρων ($P=0.383$).
- Κατά τη διάρκεια της μελέτης, οι μαστικοί αδένες ήταν μαλακοί και με ομοιογενή σύσταση. Την ημέρα D1, το μαστικό έκκριμα ήταν παχύρρευστο και κιτρινωπό, στη συνέχεια δε (περιστασιακά την ημέρα D2, αλλά πάντοτε την ημέρα D4) έγινε 'γαλακτώδες'.
- Στην υπερηχογραφική εξέταση, το μαστικό παρέγχυμα, σε γενικές γραμμές, είχε ομοιογενή σύσταση και μέτρια ηχογένεια. Με την εξέλιξη της λοχείας, παρατηρείτο μία λιγότερο ομοιογενής σύσταση με μικρότερη ηχογένεια, ενώ ταυτόχρονα υπήρχε αυξημένη ποσότητα συνδετικού ιστού στην περίοδο εκείνη. Περιστασιακά, ήταν δυνατή η απεικόνιση διαφορετικών λοβίων εντός του ίδιου μαστικού αδένα, τα οποία χωρίζονταν με συνδετικό ιστό.
- Η συχνότητα απομόνωσης βακτηρίων από το υλικό θηλαίου πόρου ήταν 6,8% στην περίοδο L1, 1,3% στην περίοδο L2, 0% στην περίοδο L3 και 2,8% στην περίοδο L4, Η συχνότητα απομόνωσης βακτηρίων από το γάλα ήταν 9,1%, 10,4%, 12,2% και 1,7%, αντίστοιχα. Εκτιμήθηκε ότι η πιθανότητα απομόνωσης βακτηρίων από το μαστικό αδένα Rc1 (οπίσθιος δεξιός) ήταν μεγαλύτερη απ' ό,τι αυτή από τους μαστικούς αδένες [Rc3 ή Rc4]. Επίσης, η πιθανότητα απομόνωσης βακτηρίων από το μαστικό αδένα Rc2 ήταν μεγαλύτερη απ' ό,τι αυτή από το μαστικό αδένα Rc4 ($P<0,02$). Επιπλέον, παρατηρήθηκε μεγαλύτερη πιθανότητα απομόνωσης βακτηρίων από τους [Rc1+Rc2] σε σύγκριση με τους [Rc3+Rc4] αδένες ($P<0,001$). Η διάμεση τιμή της περιόδου από τον τοκετό μέχρι την πρώτη μόλυνση ήταν σημαντικά μικρότερη ($P=0,044$) για τον Rc1 σε σχέση με τους Rc2, Rc3 ή Rc4 (3 ημέρες για τον Rc1, >7 ημέρες για τους Rc2, Rc3 ή Rc4). Οι περισσότεροι από τους μικροοργανισμούς που απομονώθηκαν ήταν σταφυλόκοκκοι: 14 από τα 17 (82%) που απομονώθηκαν συνολικά

από δείγματα υλικού θηλαίου πόρου και 45 στελέχη από τα 53 (85%) που απομονώθηκαν συνολικά από δείγματα γάλακτος. Πιο συχνά, ταυτοποιήθηκε *Staphylococcus pseudintermedius* (7 και 24 στελέχη, αντίστοιχα).

- Η μέση (διάμεση) τιμή της δοκιμής Whiteside (WST) σε δείγματα γάλακτος από τα οποία δεν απομονώθηκαν βακτήρια ήταν 1,78 (2,0) και σε δείγματα γάλακτος από τα οποία απομονώθηκαν βακτήρια ήταν 2,20 (2,5) [σε κλίμακα από 0-5, η οποία αντιστοιχεί σε αντίδραση από '-' έως '3+']. Υπήρχε σημαντική συσχέτιση μεταξύ αυξημένων τιμών της δοκιμής WST και δειγμάτων γάλακτος από τα οποία απομονώθηκαν βακτήρια. Η ευαισθησία της δοκιμής ήταν 74% για συσχέτιση υψηλών τιμών (\geq '1+') αυτής με απομόνωση βακτηρίων από δείγματα γάλακτος. Η μέση (διάμεση) τιμή της αντίδρασης της δοκιμής WST σε δείγματα από τέσσερις περιόδους ήταν ως εξής: 1,73 (2,0) κατά την L1, 1,68 (2,0) κατά την L2, 1,58 (2,0) κατά την L3 και 3,12 (4,0) κατά την L4. Οι τιμές της δοκιμής κατά την περίοδο L4 ήταν σημαντικά αυξημένες ($P < 0,001$). Οι τιμές της δοκιμής σε δείγματα από τον 'Rc1' αδένα ήταν σημαντικά μεγαλύτερες ($P < 0,015$) σε σχέση με αυτές από δείγματα από άλλους μαστικούς αδένες. Η πλειονότητα των κυττάρων που παρατηρήθηκαν σε επιχρίσματα γάλακτος ήταν μακροφάγα, παράλληλα όμως παρατηρήθηκαν λεμφοκύτταρα και ουδετερόφιλα λευκοκύτταρα.
- Με την εξέλιξη της λοχείας, παρατηρήθηκε σημαντική αύξηση της κινητικότητας των θηλυκών σκύλων ('μέσα στο κουτί τοκετού': $P \leq 0,001$, 'έξω από το κουτί τοκετού': $P < 0,001$), καθώς και σημαντική μείωση της αλληλεπίδρασης με τα κουτάβια ('περιποίηση κουταβιών': $P < 0,001$, 'επαφή με κουτάβια': $P < 0,001$). Επίσης, παρατηρήθηκε σημαντική αύξηση στην κινητικότητα ('μέσα στο κουτί τοκετού': $P \leq 0,001$, 'έξω από το κουτί τοκετού': $P < 0,001$) και στην ενεργητικότητα ('ξαπλώνει': $P < 0,001$, 'παίζει': $P < 0,001$) των κουταβιών κατά τη διάρκεια της περιόδου L4. Οι σχετικές με το θηλασμό συμπεριφορές των κουταβιών μειώθηκαν προοδευτικά στη διάρκεια της λοχείας ('επιτυχημένος θηλασμός': $P < 0,09$, 'επεισόδιο θηλασμού': $P < 0,08$). Δεν υπήρχε σημαντική διαφορά στη συχνότητα των επεισοδίων θηλασμού των κουταβιών στο δεξιό ή τον αριστερό στήχο μαστικών αδένων ($P = 0,973$). Αντίθετα, υπήρχε σημαντική διαφορά στη συχνότητα των επιτυχημένων θηλασμών των κουταβιών μεταξύ των οπίσθιων [Rc1+Rc2] και των πρόσθιων [Rc3+Rc4+Rc5] μαστικών αδένων ($P < 0,001$). Οι γραμμές τάσης που απεικόνιζαν τη συχνότητα των 'επιτυχημένων θηλασμών' των κουταβιών και την πιθανότητα μόλυνσης των μαστικών αδένων και των θηλαίων πόρων συμπορεύονταν σε όλη τη διάρκεια της μελέτης.
- Μακροσκοπικά, η μήτρα είχε χρώμα ρόδινο, με επιμήκεις πτυχώσεις και μέτρια αγγείωση. Τα κέρατα της μήτρας ήταν συμμετρικά μεταξύ τους και πλαγίως αποπλατυσμένα. Μακροσκοπικά, οι θέσεις πρόσφυσης των εμβρυϊκών υμένων μπορούσαν να γίνουν

αντιληπτές μέχρι την 84η ημέρα μετά τον τοκετό. Οι μέσες τιμές του πλάτους των κεράτων της μήτρας (στις θέσεις πρόσφυσης εμβρυϊκών υμένων / στα μεσοδιαστήματα μεταξύ των θέσεων πρόσφυσης, αντίστοιχα) ήταν διαφορετικές στα επί μέρους χρονικά σημεία: 2,8 / 2,7 cm την ημέρα D7, 1,7 / 1,2 cm την ημέρα D35 και 0,9 / 0,8 cm την ημέρα D84 ($P \leq 0,001$). Παρατηρήθηκε μικρή ποσότητα υγρού, χρώματος κόκκινου έως έντονα καστανού, στην κοιλότητα της μήτρας σε επτά σκύλες μέχρι την ημέρα D42. Οι θέσεις πρόσφυσης των εμβρυϊκών υμένων είχαν χρώμα αρχικά σκούρο πράσινο έως γκριζωπό, ενώ αργότερα το χρώμα έγινε έντονα καστανό. Οι θέσεις πρόσφυσης ήταν παχυμένες και με 'αφρώδη' επιφάνεια. Οι διαστάσεις τους προοδευτικά μειώνονταν κατά τη διάρκεια της λοχείας. Οι περιοχές μεσοδιαστήματος είχαν χρώμα λευκό έως ροδαλό, με αβαθείς επιμήκεις ρυτιδώσεις. Το μήκος τους προοδευτικά αυξάνονταν κατά τη διάρκεια της λοχείας.

- Βακτήρια απομονώθηκαν από δείγματα περιεχομένου της μήτρας από τα ζώα που χειρουργήθηκαν την ημέρα D4 και την ημέρα D7, από τα οποία απομονώθηκαν *E. coli* και *T. pyogenes*, αντίστοιχα. Η πλειονότητα των κυττάρων σε επιχρίσματα περιεχομένου μήτρας στα αρχικά μετά τον τοκετό στάδια, ήταν λευκοκύτταρα, κυρίως δε ουδετερόφιλα λευκοκύτταρα. Από την ημέρα D56 και μετά, στα επιχρίσματα προεξήρχαν τα επιθηλιακά κύτταρα της μήτρας.
- Κατά την περίοδο L1, το μωμήτριο ήταν ιδιαίτερα παχυμένο (1887 μm την ημέρα D7). Το παχυμένο ενδομήτριο παρουσίαζε πτυχώσεις και έντονη αγγείωση στο χόριο, όπου παρατηρήθηκε αυξημένος αριθμός φλεγμονωδών κυττάρων. Το επιθήλιο ήταν μονόστιβο κυβοειδές ή κυλινδρικό. Τα επιθηλιακά κύτταρα ήταν διογκωμένα, σε συσσωματώματα και είχαν 'κενοτοπιώδες' κυτταρόπλασμα. Συσσωματώματα από 'κενοτοπιώδη' κύτταρα παρατηρήθηκαν σε όλη την έκταση του επιθηλίου. Παρατηρήθηκε έντονη απόπτωση επιθηλιακών κυττάρων στον αυλό της μήτρας. Κατά την περίοδο L2, η ένταση των παραπάνω ευρημάτων σταδιακά μειώθηκε. Κατά την περίοδο L3, το πάχος όλων των στιβάδων του μωμητρίου είχε μειωθεί. Για πρώτη φορά, παρατηρήθηκαν φλεγμονώδη κύτταρα στην εσωτερική στιβάδα του μωμητρίου. Το επιθήλιο ήταν μονόστιβο κυβοειδές ή κυλινδρικό. 'Κενοτοπιώδη' κύτταρα παρατηρήθηκαν μόνο στα σημεία του επιθηλίου που αντιστοιχούσαν στις θέσεις πρόσφυσης των εμβρυϊκών υμένων. Κατά την περίοδο L4, το πάχος του συνόλου του τοιχώματος της μήτρας μειώθηκε περαιτέρω (1255 μm την ημέρα D70). Οι μητριάιοι αδένες ήταν εμφανείς, αλλά η διάμετρός τους είχε μειωθεί. Το επιθήλιο ήταν μονόστιβο κυβοειδές. Μερικά 'κενοτοπιώδη' κύτταρα ήταν παρόντα στα σημεία του επιθηλίου, τα οποία αντιστοιχούσαν στις θέσεις πρόσφυσης των εμβρυϊκών υμένων. Η διάμεση διάμετρος των μητριάιων αδένων σε εγκάρσιες τομές ήταν 79 μm την ημέρα D7, 53 μm την ημέρα D56 και 52 μm την ημέρα D84 ($P=0,032$). Παρατηρήθηκαν επίσης σημαντικές διαφορές στο ύψος των

επιθηλιακών κυττάρων των μητριαίων αδένων, που ήταν 9,4 μm την ημέρα D7, 6,2 μm την ημέρα D56 και 6,4 μm την ημέρα D84 ($P=0,035$).

- Μακροσκοπικά, οι μαστικοί αδένες είχαν παραλληλόγραμμο έως σχεδόν τετράγωνο σχήμα, με ροδαλό έως ελαφρά ερυθρό χρωματισμό. Από την ημέρα D56, παρατηρήθηκε υποκίτρινος χρωματισμός σε ορισμένες περιοχές των μαστικών αδένων. Δεν διαπιστώθηκε συσχέτιση του αριθμού των θηλαίων πόρων με την πιθανότητα μόλυνσης του μαστικού αδένα. Οι διαστάσεις των μαστικών αδένων ήταν αυξημένες από την ημέρα D14 μέχρι την ημέρα D42 και, στη συνέχεια, σταδιακά μειώνονταν. Από την ημέρα D4 έως την ημέρα D42, οι διαστάσεις του μαστικού αδένα Rc2 ήταν μεγαλύτερες από αυτές του Rc1, τάση που αντιστράφηκε από τη ημέρα D56. Σε γενικές γραμμές, οι διαστάσεις των μαστικών αδένων Rc1 και Rc2 ήταν μεγαλύτερες από αυτές του Rc3. Η προοδευτική μείωση των διαστάσεων των μαστικών αδένων στη διάρκεια της μελέτης ήταν σημαντική ($P<0,001$).
- Δεν απομονώθηκαν βακτήρια από κανένα δείγμα μαστικού παρεγχύματος από κανένα ζώο.
- Σε όλους τους μαστικούς αδένες που μελετήθηκαν, όλοι οι λοβοί και τα λόβια στον ίδιο αδένα είχαν παρόμοια ιστολογική δομή. Τα ευρήματα σε όλους τους μαστικούς αδένες του ίδιου ζώου ήταν ομοιόμορφα: μέχρι την ημέρα D42 όλοι οι μαστικοί αδένες του ίδιου ζώου βρίσκονταν σε πλήρη γαλακτοπαραγωγή, ενώ την ημέρα D70 και μετέπειτα παρατηρήθηκε παλινδρόμηση των μαστικών αδένων. Ειδικά την ημέρα D56, παρατηρήθηκαν διαφορές μεταξύ των μαστικών αδένων του ζώου: συγκεκριμένα, τρεις μαστικοί αδένες βρίσκονταν σε πλήρη γαλακτοπαραγωγή, ενώ στον τέταρτο παρατηρήθηκε παλινδρόμηση. Φλεγμονώδη κύτταρα παρατηρήθηκαν στο μεσολόβιο χώρο όλων των αδένων. Μέχρι την ημέρα D42, τα λόβια του μαστού διαχωρίζονταν με ελάχιστη ποσότητα συνδετικού ιστού. Οι αδενοκυψελίδες ήταν πλήρως αναπτυγμένες και διασταλμένες, με σφαιρική έως ελαφρά ωοειδή δομή, και περιβάλλονταν από μυοεπιθηλιακά κύτταρα. Τα επιθηλιακά κύτταρα παρουσίαζαν ομοιογένεια και ήταν κυβοειδή έως ελαφρώς παραλληλεπίπεδα. Από την ημέρα D70, ο μεσολόβιος συνδετικός ιστός ήταν αφθονότερος και πιο πυκνός, καταλαμβάνοντας ένα μεγάλο τμήμα των οπτικών πεδίων. Παρατηρήθηκε αυξημένος αριθμός ινοβλαστών. Ο συνδετικός ιστός μεταξύ των λοβίων περιείχε φλεγμονώδη κύτταρα. Οι αδενοκυψελίδες παρουσιάζονταν με ακανόνιστο σχήμα και ήταν συρρικνωμένες. Τα ελάχιστα επιθηλιακά κύτταρα των αδενοκυψελίδων ήταν αποπλατυσμένα. Η διάμεση τιμή των αδενοκυψελίδων ανά λόβιο μειωνόταν προοδευτικά κατά τη διάρκεια της μελέτης ($P<0,001$). Η διάμεση τιμή των επιθηλιακών κυττάρων ανά αδενοκυψελίδα επίσης μειωνόταν προοδευτικά ($P=0,005$). Ο αδένας Rc3 είχε σημαντικά μικρότερο αριθμό αδενοκυψελίδων από τους Rc1 ή Rc2. Δεν παρατηρήθηκαν σημαντικές διαφορές στον αριθμό των επιθηλιακών κυττάρων ανά αδενοκυψελίδα μεταξύ των διαφόρων

μαστικών αδένων. Η διάμεση τιμή της διαμέτρου των αδενοκυψελίδων και η διάμεση τιμή του ύψους των επιθηλιακών κυττάρων μειώθηκαν σημαντικά στην περίοδο L4 ($P < 0,045$).

Τα συμπεράσματα που προκύπτουν από τα αποτελέσματα της παρούσας διατριβής, συνοψίζονται παρακάτω.

(α) Φαίνεται ότι, για ορισμένες αιματολογικές παραμέτρους και βιοχημικές παραμέτρους στον ορό του αίματος, κατά την περί τον τοκετό περίοδο, ισχύουν τιμές 'αναφοράς' διαφορετικές από τις καθιερωμένες. Ειδικότερα, παρουσιάζονται νέα προτεινόμενα όρια τιμών 'αναφοράς' για τον αιματοκρίτη, το συνολικό αριθμό λευκοκυττάρων, τον αριθμό θρομβοκυττάρων, τη συγκέντρωση αιμοσφαιρίνης, τον αριθμό ώριμων ουδετερόφιλων λευκοκυττάρων, το συνολικό αριθμό λεμφοκυττάρων, τη συγκέντρωση ολικών πρωτεϊνών, τη συγκέντρωση αλβουμίνης και τη συγκέντρωση C-αντιδρώσας πρωτεΐνης.

(β) Τα υπερηχοτομογραφικά ευρήματα στη μήτρα και στους μαστικούς αδένες μπορούν να χρησιμοποιηθούν ως στοιχεία αναφοράς για απεικονίσεις σε σκύλες στη διάρκεια της λοχείας.

(γ) Οι τρέχουσες απόψεις σχετικά με τη διάρκεια την παλινδρόμησης του γεννητικού συστήματος των θηλυκών σκύλων μετά τον τοκετό, ενδεχομένως, πρέπει να αναθεωρηθούν. Ειδικά σε πρωτοτόκες σκύλες, μπορεί να θεωρηθεί ότι η διαδικασία της παλινδρόμησης διαρκεί φυσιολογικά περισσότερο απ' ό,τι σε πολυτόκες σκύλες. Η σημασία των 'κενοτοπιωδών' κυττάρων στη μήτρα πρέπει να επαναξιολογηθεί, ενδεχομένως δε η παρουσία τους μπορεί να θεωρηθεί ως φυσιολογικό χαρακτηριστικό. Ίσως, πρέπει να ληφθεί υπόψη η ποσότητα των κυττάρων αυτών σε συνδυασμό με άλλα παθολογικά ευρήματα ως ενδείξεις ατελούς παλινδρόμησης των περιοχών πρόσφυσης των εμβρυϊκών υμένων.

(δ) Παρά την αυξημένη πιθανότητα μόλυνσης (*E. coli*, *T. pyogenes*) του γεννητικού συστήματος στην αμέσως μετά τον τοκετό περίοδο, οι αποτελεσματικοί κυτταρικοί αμυντικοί μηχανισμοί (ουδετερόφιλα λευκοκύτταρα) του ζώου συμβάλλουν στην προστασία για αποφυγή εκδήλωσης μητρίτιδας.

(ε) Η παλινδρόμηση των μαστικών αδένων αρχίζει περίπου στο τέλος του 2ου μήνα μετά τον τοκετό. Μέχρι το τέλος του 3ου μήνα μετά τον τοκετό (σε περιπτώσεις όπου η σκύλα ακόμα γαλουχεί τα κουτάβια της) η διαδικασία έχει σχεδόν ολοκληρωθεί.

(στ) Οι σταφυλόκοκκοι είναι οι κύριοι μικροοργανισμοί που απομονώνονταν από δείγματα γάλακτος από υγιείς θηλυκούς σκύλους στη διάρκεια της λοχείας. Οι μικροοργανισμοί αυτοί μάλλον προέρχονταν από το δέρμα του ζώου. Η πιθανότητα μόλυνσης των οπίσθιων μαστικών αδένων είναι αυξημένη σε σύγκριση με αυτή των προσθιότερων αδένων. Η πιθανότητα μόλυνσης στο αρχικό στάδιο της λοχείας είναι μεγαλύτερη από αυτήν στα επόμενα στάδια.

(ζ) Τα μακροφάγα και τα λεμφοκύτταρα αποτελούν τις κύριες κατηγορίες κυττάρων που παρατηρούνται στους μαστικούς αδένες. Η δοκιμή Whiteside φαίνεται ότι είναι χρήσιμη για ανίχνευση αυξημένου αριθμού κυττάρων στο γάλα των θηλυκών σκύλων.

(η) Οι ηθολογικές παρατηρήσεις υποδεικνύουν ότι ο θηλασμός φαίνεται να συμβάλλει σε αυξημένη πιθανότητα μόλυνσης των οπίσθιων μαστικών αδένων στην αρχική περίοδο της λοχείας. Τα ζώα δεν παρουσίασαν αρνητικές συμπεριφορές στη διάρκεια της μελέτης. Γενικά, το μέγεθος της τοκετομάδας δεν επηρέαζε τη συμπεριφορά των θηλυκών σκύλων και των κουταβιών τους.

Με βάση την κείμενη νομοθεσία και μετά από σχετική απόφαση στη με αριθμό 46/25.10.2011 συνεδρίαση της Γενικής Συνέλευσης Ειδικής Σύθεσης του Τμήματος Κτηνιατρικής του Πανεπιστημίου Θεσσαλίας, η συγγραφή της διατριβής έγινε στην αγγλική γλώσσα.

Δημοσιεύσεις σχετιζόμενες με την παρούσα διατριβή

Στις παρακάτω επιστημονικές δημοσιεύσεις παρουσιάζονται τμήματα της παρούσας διατριβής:

- I. D.C. Orfanou, H.N. Ververidis, A. Pourlis, I.A. Fragkou, A.N. Kokoli, C.M. Boscós, I.A. Taitzoglou, A. Tzora, C.M. Nerou, L.V. Athanasiou, G.C. Fthenakis (2009). "Post-partum involution of the canine uterus - Gross-anatomical and histological features" *Reproduction in domestic Animals*, 44(Suppl. 2):152-155.
- II. D.C. Orfanou, A. Pourlis, H.N. Ververidis, V.S. Mavrogianni, I.A. Taitzoglou, C.M. Boscós, G.C. Fthenakis (2009). "Histological features in the mammary gland of female dogs" *Anatomia Histologia Embryologia*, 39:473-478.
- III. D.C. Orfanou, H.N. Ververidis, C.M. Boscós, G.C. Fthenakis (2010). "Post-partum pathological conditions in the bitch- Part I" *The European Journal of companion Animal Practice*, 20:21-29.
- IV. D.C. Orfanou, H.N. Ververidis, C.M. Boscós, G.C. Fthenakis (2010). "Post-partum pathological conditions in the bitch- Part II" *The European Journal of companion Animal Practice*, 20:119-126.

ΤΡΙΜΕΛΗΣ ΣΥΜΒΟΥΛΕΥΤΙΚΗ ΕΠΙΤΡΟΠΗ

Γ.Χ. Φθενάκης, Καθηγητής

Κλινική Μαιευτικής και Αναπαραγωγής, Τμήμα Κτηνιατρικής, Πανεπιστήμιο Θεσσαλίας

Επιβλέπων

Κ.Μ. Μπόσκος, Καθηγητής

Κλινική Παραγωγικών Ζώων, Κτηνιατρική Σχολή, Αριστοτέλειο Πανεπιστήμιο Θεσσαλονίκης

Μέλος Συμβουλευτικής Επιτροπής

Ι.Α. Ταϊτζόγλου, Καθηγητής

Εργαστήριο Φυσιολογίας, Κτηνιατρική Σχολή, Αριστοτέλειο Πανεπιστήμιο Θεσσαλονίκης

Μέλος Συμβουλευτικής Επιτροπής

ΕΠΤΑΜΕΛΗΣ ΕΞΕΤΑΣΤΙΚΗ ΕΠΙΤΡΟΠΗ

Κ. Μπόσκος, Καθηγητής

Κτηνιατρική Σχολή, Αριστοτέλειο Πανεπιστήμιο Θεσσαλονίκης

Ι.Α. Ταϊτζόγλου, Καθηγητής

Κτηνιατρική Σχολή, Αριστοτέλειο Πανεπιστήμιο Θεσσαλονίκης

Γ.Χ. Φθενάκης, Καθηγητής

Τμήμα Κτηνιατρικής, Πανεπιστήμιο Θεσσαλίας

Α.Υ.Μ. Fontbonne, Αναπληρωτής καθηγητής

École National Vétérinaire d' Alfort

Γ.Σ. Αμοιρίδης, Αναπληρωτής καθηγητής

Τμήμα Κτηνιατρικής, Πανεπιστήμιο Θεσσαλίας

Χ.Ν. Βερβερίδης, Επίκουρος καθηγητής

Κτηνιατρική Σχολή, Αριστοτέλειο Πανεπιστήμιο Θεσσαλονίκης

Α. Πούρλης, Επίκουρος καθηγητής

Τμήμα Κτηνιατρικής, Πανεπιστήμιο Θεσσαλίας

UNIVERSITY OF THESSALY

SCHOOL OF HEALTH SCIENCES

FACULTY OF VETERINARY MEDICINE

**INVESTIGATIONS INTO THE *PUERPERIUM*
OF BEAGLE-BREED FEMALE DOGS**

DIONYSIA C. ORFANO

DVM (Thessaly)

**A THESIS SUBMITTED FOR THE DEGREE OF
DOCTOR OF PHILOSOPHY**

Work carried out at the Department of Obstetrics and Reproduction
of the Faculty of Veterinary Medicine of the University of Thessaly

Karditsa, Greece 2012

ABSTRACT

The present thesis focusses on the study of the *puerperium* of female dogs, with the general objective to increase available knowledge regarding the *puerperium* of that species and to elucidate the process of involution of the uterus and the mammary glands in female dogs. Specific objectives of the thesis were as follows: (i) a proposal of 'reference' values for haematological and blood biochemical parametres during the *puerperium*, (ii) the description of anatomical details and their progressive changes in the uterus and the mammary glands during the *puerperium*, (iii) the identification of time periods, during which the uterus and the mammary glands are more susceptible to infection, (iv) the identification of cells present in the uterine content and in the milk and (v) the study of sucking behaviour during lactation and the identification of potential risk factors for mammary infections.

Initially (1st Chapter), the relevant literature is reviewed. The Chapter is subdivided into three Parts. In Part A, principles of anatomy of the reproductive system and of physiology of the *puerperium* of female dogs are briefly reviewed. In Part B, the literature on pathological conditions of female dogs during the *puerperium* (systemic *post-partum* pathological conditions, *post-partum* pathological conditions of the uterus, *post-partum* pathological conditions of the mammary glands) is reviewed. In Part C, the ovario-hysterectomy during the *puerperium* is presented.

Materials and methods used are described in detail in the 2nd Chapter. In total, 12 primiparous Beagle-breed female dogs were used in the study. Animals whelped normally. Subsequently, all animals were monitored until the 84th day *post-partum*. The following examinations were carried out: (i) general clinical examination (female dogs and puppies), (ii) clinical examination of the genital system, (iii) ultrasonographic examination of the uterus and the ovaries, (iv) clinical examination of the mammary glands, (v) ultrasonographic examination of the mammary glands, (vi) measurement of haematological and blood biochemical parametres, (vii) measurement of blood serum progesterone concentration, (viii) bacteriological and cytological examination of vaginal swab samples, (ix) bacteriological examination and cytological examination of teat duct material and milk samples, (x) behavioural observations. Dogs were subjected to ovario-hysterectomy and partial mastectomy on each of 4th, 7th, 10th, 14th, 21st, 28th, 35th, 42nd, 56th, 70th and 84th day after whelping. Appropriate tissue samples were collected for detailed examinations and the following were studied: (i) gross appearance of the uterus and the ovaries, (ii) bacteriological and cytological examination of uterine content samples, (iii) histological,

histometric and ultrastructural examination of uterus and ovary tissue samples, (iv) bacteriological examination of mammary parenchyma samples, (v) histological, histometric and ultrastructural examination of mammary parenchyma tissue samples. Standard clinical, paraclinical, laboratory, behavioural and data analysis techniques were employed. For the purposes of analysis of results of the study, the *puerperium* was divided into four stages: L1 included samples collected from D0 (i.e., day of whelping) to D7 (7 days after whelping) (n=59), L2 included samples collected from D8 to D21 (n=27), L3 included samples collected from D22 to D42 (n=18) and L4 included samples collected from D43 to D84 (n=18). Specifically for analysis of haematological and blood biochemical parameters, samples collected during pregnancy were also taken into account.

The results of the study are presented in the 3rd Chapter and are summarised herebelow.

- Animals were clinically healthy throughout the study.
- A significant effect of the peri-parturient period (last week of pregnancy and first week of the *puerperium*) was observed for the following parameters, rendering proposed 'reference' values during that period as follows: haematocrit 24.1-35.3%, leucocyte counts 13,200-31,400 μL^{-1} , thrombocyte counts 502,000-912,000 μL^{-1} , haemoglobin concentration 7.7-10.6 g dL^{-1} , mature neutrophil counts 8,500-25,200 μL^{-1} , lymphocyte counts 2,200-7,500 μL^{-1} , total protein concentration 4.3-6.4 g dL^{-1} , albumin concentration 1.7-2.6 g dL^{-1} and C-reactive protein concentration 30.0-180.0 mg L^{-1} . Other parameters (alkaline phosphatase activity, calcium-ion concentration and total calcium concentration) were significantly affected during the peri-parturient period, but remained within the established 'reference' values. Finally, other parameters (mean corpuscular haemoglobin concentration, fibrinogen concentration, mature neutrophils proportion, immature neutrophils counts and proportion, lymphocytes proportion, monocyte counts and proportion, eosinophil counts, basophil counts, globulin concentration, glucose concentration, magnesium concentration) were not affected.
- Median value of blood serum progesterone concentration was 0.43 ng mL^{-1} ; it was higher in [L1+L2] compared to [L3+L4] (0.48 ng mL^{-1} versus 0.32 ng mL^{-1} , $P=0.013$).
- Vaginal discharge was observed in 58% of sampling occasions, continuously up to D21 and intermittently up to D77, in 'scanty' to 'small' amount. Median diameter of the body of the uterus, as estimated during palpation through the abdominal wall, was progressively reduced during the *puerperium*; it was estimated at ~3.0 cm on D0 to <1.0 cm on D28 and subsequently ($P=0.01$). Median value of dimensions of the vulva during the *puerperium* were as follows: total horizontal width \times total vertical length = 2.7 cm \times 3.4 cm; median value of distance from anus to upper vulval commissure was 8.0 cm. Dimensions of the external genitalia progressively decreased during the study.

- Up to D21, the uterus appeared with a heterogeneous echopattern; it was easy to recognize and image the organ, because width of the uterine horns was estimated to be ≥ 1.0 cm. After that day, it was more difficult to image it, as their width was progressively decreasing and, on D70, was estimated to be 0.6 to 0.7 cm ($P < 0.001$). In longitudinal images, the uterus appeared consistently cylindrical in shape. In transverse images taken up to D21, the sections of the organ appeared polygonal to compressed circular to circular; in transverse images taken after D21, they appeared consistently circular. There was evidence of a hypoechoic rim, with a more echogenic inner architecture. In some images, the anechoic lumen was barely visible, because of the more echogenic content, whilst in others, it was observed greatly contrasting to the hyperechoic endometrium. The placental sites appeared as granulated structures of medium echogenicity, with small anechoic areas. Initially, the uterine wall was imaged as a multi-layer structure, but, subsequently, number of layers imaged was reduced. Thickness of myometrium and endometrium was found to progressively decrease as the puerperium advanced ($P < 0.001$), as was diameter of the lumen of uterine horns ($P = 0.003$).
- In total, 51 of 122 vaginal samples examined bacteriologically, yielded bacteria. Frequency of bacterial isolation from vaginal samples was 0.525 during L1, 0.333 during L2, 0.333 during L3 and 0.278 during L4 ($P = 0.094$). Median time to first infection after whelping was 0.25 days. Estimated median duration of infection (all infections taken into account) was 5.25 days. Most of the organisms recovered were *Escherichia coli* and *Trueperella (Arcanobacterium) pyogenes*: 22 and 16, respectively, of the 55 isolates recovered.
- In smears from swab samples from the anterior part of the vagina, the majority of cells observed were epithelial cells. Uterine epithelial cells, normal or degenerated, were observed characteristically clustered, whilst vaginal cells observed were primarily parabasal or small intermediate cells. Leucocytes were also observed in these smears; neutrophils predominated. Trophoblast-like cells were also evident in L1 and L2. There was a progressive increase in epithelial cell counting scores and progressive decrease in leucocyte counting scores observed during the puerperium ($P < 0.04$). Cell counting scores for samples which had yielded bacteria were significantly higher for leucocytes ($P = 0.045$), but not for epithelial cell counting scores ($P = 0.383$).
- During the study, the mammary glands were soft and with homogeneous consistency. On D1, the mammary secretion was thick and yellowish, thereafter (occasionally on D2, but always on D4) becoming 'milky'.
- The mammary parenchyma showed, in general, a homogeneous consistency and medium echogenicity. As the puerperium advanced, a less homogeneous echopattern was seen and

(compared to previous periods) lower echogenicity was recorded; increased amount of connective tissue was also evident in ultrasonograms during that period. Occasionally, it was possible to image different lobules within the same mammary gland, separated by connective interlobular tissue.

- Frequency of bacterial isolation from teat ducts was 0.068 during L1, 0.130 during L2, 0.0 during L3 and 0.028 during L4; frequency of bacterial isolation from mammary glands was 0.091, 0.104, 0.122 and 0.017, respectively. There was a greater probability of bacterial isolation from Rc1 (right most caudal gland) than [Rc3 or Rc4] glands, as well as from Rc2 than Rc4 glands ($P<0.02$); there was also a greater probability of bacterial isolation from [Rc1+Rc2] than from [Rc3+Rc4] glands ($P<0.001$). Median time to first infection after whelping was significantly ($P=0.044$) shorter for Rc1 than for Rc2, Rc3 or Rc4 (median time: 3 days for Rc1, >7 days for Rc2, Rc3 or Rc4). Most of the organisms recovered were staphylococci: 14 of the 17 isolates (82%) from teat duct material and 45 of the 53 isolates (85%) from milk; *Staphylococcus pseudintermedius* was the most frequently recovered species (7 and 24 isolates, respectively).
- Mean (median) Whiteside test (WST) score of bacteriologically negative milk samples was 1.78 (2.0) and that of bacteriologically positive milk samples was 2.20 (2.5) [in a 0 to 5 scale corresponding to scores '-' to '3+']. There was a significant association between increased WST scores and bacteriologically positive results in milk samples. Overall sensitivity of the test was 74% for 'high' (i.e., $\geq 1+$) WST scores to identifying bacterial isolation from milk samples. Mean (median) WST scores of milk samples collected during each of the four *puerperium* stages were as follows: 1.73 (2.0) in L1, 1.68 (2.0) in L2, 1.58 (2.0) in L3 and 3.12 (4.0) in L4; scores in samples collected during L4 were significantly ($P<0.001$) greater. Scores in samples collected from 'Rc1' gland were significantly ($P<0.015$) greater than in samples from the other mammary glands. The majority of cells observed in milk films were macrophages, although lymphocytes and neutrophils were also present therein.
- As the *puerperium* advanced, there was a significant progressive increase in mobility of the bitches ('Inside whelping box': $P\leq 0.001$, 'Outside whelping box': $P<0.001$), as well as a significant progressive decrease of interaction with puppies ('Grooming puppy': $P<0.001$, 'Contact with puppies': $P<0.001$). Moreover, there was a significant increase in mobility ('Inside whelping box': $P\leq 0.001$, 'Outside whelping box': $P<0.001$) and activity ('Lie down': $P<0.001$, 'Playing': $P<0.001$) of the puppies during L4. Sucking behaviours decreased progressively as the *puerperium* advanced ('Successful suck': $P<0.09$, 'Sucking bout': $P<0.08$). There was no significant difference in the frequency of successful sucks of puppies between the right and the

left mammary glands ($P=0.973$), but there was a significant difference in the frequency of successful sucks of puppies between the more caudal (i.e., [Rc1+Rc2]) and more cranial (i.e., [Rc3+Rc4+Rc5]) mammary glands ($P<0.001$). Tendency lines drawn for frequency of 'Successful sucks' of puppies and risk of infection for five mammary glands (Rc1, Rc2, Rc3, Rc4 and Lc2) and two teat ducts (Rd2, Ld2) of their dams were associated throughout the study.

- Externally, the uterus was pink, with longitudinal folds and mild vascularization. The two horns were symmetrical between them and laterally oblate; macroscopically, the placental sites could be appreciated even up to D84. Mean widths of the uterine horns were different across the various time-points: 2.8 / 2.7 cm (placental sites / interplacental areas) on D7, 1.7 / 1.2 cm (placental sites / interplacental areas) on D35 and 0.9 / 0.8 cm (placental sites / interplacental areas) on D84 ($P\leq 0.001$). There was a small amount of viscous to mucous, red to dark-brownish fluid inside the uterus of seven bitches up to D42 of the *puerperium*. The placental sites were initially of dark green to grey colour, whilst later they were dark brown; these were easily recognized, thickened and with 'foamy'-like surface; their length progressively decreased. The interplacental areas were white to pink colour with mild longitudinal wrinkles thereon; their length progressively increased.
- Bacteria were isolated from swabs cultured from the uterine content of the bitch operated on D4 and from that of the bitch operated on D7; *E. coli* and *T. pyogenes* were isolated, respectively. In smears from swab samples from the uterine content, the majority of cells observed were initially leucocytes, with neutrophils predominating. Uterine epithelial cells predominated from D56 of the *puerperium* onwards.
- During L1, the myometrium was very thickened (1887 μm on D7). The thickened endometrium showed folding and increased vascularisation in the lamina propria. High numbers of inflammatory cells were observed subepithelially. A simple, cuboidal to columnar epithelium was seen; the epithelial cells were enlarged, clustered and with a 'foamy' cytoplasm. Clusters of 'foamy' cells were evident along the entire epithelial lining. Increased desquamation of epithelial cells was seen into the lumen. During L2, the intensity of the above findings progressively decreased. During L3, thickness of all layers of the myometrium was reduced. Inflammatory cells were first evident in the inner layer of the myometrium. A simple, cuboidal to columnar epithelium was seen; 'foamy' cells were also observed, but only at the part of the epithelium lining corresponding to the placental sites. During L4, thickness of the myometrium was further decreased (1255 μm of D70). Uterine glands were evident, although their diameter had decreased. A simple, cuboidal epithelium was seen; some 'foamy' cells were also

observed at the part of the epithelium lining corresponding to the placental sites. Median diameter of the uterine glands' transverse sections was 79 μm on D7, 53 μm on D56 and 52 μm on D84 ($P=0.032$); moreover, significant differences were also seen in the height of glandular epithelial cells: 9.4 μm on D4, 6.2 μm on D35, 6.4 μm on D70 ($P=0.035$).

- The mammary glands appeared rectangular to almost square, with pink to mildly red colour; from D56 of the *puerperium*, pale yellow colouration was also evident in some areas of the mammary glands. There was no association between the number of teat orifices and the risk of infection of the respective mammary gland. Dimensions of the mammary glands were greatest during D14 to D42, then, progressively, decreased. From D4 to D42, dimensions of Rc2 were greater than those of Rc1, a pattern which changed from D56 onwards; in general, dimensions of Rc1 and Rc2 were greater than those of Rc3. The decrease of dimensions of the mammary glands observed during the study was significant ($P<0.001$).
- No bacteria were isolated from any mammary parenchyma tissue sample of any bitch.
- In all mammary glands studied, all lobes and lobules within the same sample had similar histological features. Similarities were evident in the mammary glands of the same animal: up to D42, all mammary glands of the same animal were in full lactation, whilst on D70 and thereafter, all mammary glands of the same animal showed evidence of involution. Specifically on D56, differences were observed among the mammary glands of the animal, i.e. three mammary glands showed findings of being in full lactation, whilst a fourth showed evidence of involution. Inflammatory cells (predominantly macrophages and lymphocytes) were observed in the inter-alveolar space of all mammary glands. Until D42, mammary lobules were separated with a scant amount of connective tissue. Alveoli were well developed and distended; they appeared to have a spherical to slightly ovoid structure, with myoepithelial cells grasping them around. The epithelial cells were uniform, cubical to slightly parallelepiped in shape. From D70, the between-lobules connective tissue was abundant and dense, occupying a major part of each optical field; increased numbers of fibroblasts were observed; the stroma of connective tissue within the lobules contained inflammatory cells; alveoli appeared irregularly-shaped and collapsing, shrunken or fully collapsed; the few epithelial cells in each alveolus were flattened and slender. Median number of alveoli per lobule decreased as the *puerperium* progressed ($P<0.001$); median number of epithelial cells per alveolus also decreased ($P=0.005$). Rc3 mammary glands had a significantly smaller number of alveoli than Rc1 or Rc2 mammary glands. No significant differences were evident between the number of epithelial cells per alveolus between the mammary glands. Median diameter of alveoli and median height of epithelial cells decreased significantly in L4 ($P<0.045$).

The conclusions from the results of the present thesis are summarised herebelow.

- (a) 'Reference' values for haematological and blood biochemical values are proposed for samples collected from bitches during the peri-parturient period. New values are proposed for haematocrit, leucocyte counts, thrombocyte counts, haemoglobin concentration, mature neutrophil counts, lymphocyte counts, total protein concentration, albumin concentration and C-reactive protein concentration.
- (b) The present ultrasonographic findings of the uterus and the mammary glands can be used as further reference data for imaging standards in bitches during the *puerperium*.
- (c) Current concepts about the length of *post-partum* involution of the genital system of bitches might need to be re-addressed. In primiparous animals, one may propose that involution could normally take longer than in multiparous bitches. The significance of 'foamy' cells in the uterus could be re-assessed and their presence could be considered as a normal feature. Perhaps, the quantity of such cells observed in samples from the animals, as well as other abnormal findings that might indicate subinvolution of placental sites, should be taken into account.
- (d) Despite a very high infection rate of the genital system in the immediately *post-partum* period, effective cellular (neutrophils) defences of the animal contribute to protection from development of metritis.
- (e) Involution of the mammary glands starts around the end of the 2nd month after whelping. By the end of the 3rd month after whelping (in cases the dam is still suckling puppies), the process is almost complete.
- (f) Staphylococci are the primary bacteria isolated from milk samples of healthy female dogs during lactation. The organisms likely originate from the skin of the animal. Infection risk of the caudal mammary glands is increased compared to that of the cranial glands. Infection risk during the early *post-partum* period is increased compared to that in later stages.
- (g) Macrophages and lymphocytes constitute the main cells present in mammary glands. The Whiteside test appears to be useful for detecting increased cellular content in the milk of female dogs.
- (h) Ethological observations indicate an association of normal behaviour with potential health problems. Sucking is a factor contributing to the increased infection risk of the caudal glands and of the early *post-partum* period. No adverse behaviours were observed in the dams. In general, litter size did not affect behaviours of female animals and their puppies.

Publications associated with the present thesis

The following scientific papers presenting facets of the present thesis, are available:

- I. D.C. Orfanou, H.N. Ververidis, A. Pourlis, I.A. Fragkou, A.N. Kokoli, C.M. Boscós, I.A. Taitzoglou, A. Tzora, C.M. Nerou, L.V. Athanasiou, G.C. Fthenakis (2009). "Post-partum involution of the canine uterus - Gross-anatomical and histological features" *Reproduction in domestic Animals*, 44(Suppl. 2):152-155.
- II. D.C. Orfanou, A. Pourlis, H.N. Ververidis, V.S. Mavrogianni, I.A. Taitzoglou, C.M. Boscós, G.C. Fthenakis (2009). "Histological features in the mammary gland of female dogs" *Anatomia Histologia Embryologia*, 39:473-478.
- III. D.C. Orfanou, H.N. Ververidis, C.M. Boscós, G.C. Fthenakis (2010). "Post-partum pathological conditions in the bitch- Part I" *The European Journal of companion Animal Practice*, 20:21-29.
- IV. D.C. Orfanou, H.N. Ververidis, C.M. Boscós, G.C. Fthenakis (2010). "Post-partum pathological conditions in the bitch- Part II" *The European Journal of companion Animal Practice*, 20:119-126.

ADVISORY COMMITTEE

Professor G.C. Fthenakis	Supervisor
Department of Obstetrics and Reproduction, Faculty of Veterinary Medicine, University of Thessaly	
Professor C.M. Boscós	Member of the advisory committee
Department of Farm Animals, School of Veterinary Medicine, Aristotle University of Thessaloniki	
Professor I.A. Taitzoglou	Member of the advisory committee
Department of Physiology, School of Veterinary Medicine, Aristotle University of Thessaloniki	

EXAMINATION BOARD

Professor C.M. Boscós	School of Veterinary Medicine, Aristotle University of Thessaloniki
Professor G.C. Fthenakis	Faculty of Veterinary Medicine, University of Thessaly
Professor I.A. Taitzoglou	School of Veterinary Medicine, Aristotle University of Thessaloniki
Associate Professor G.S. Amiridis	Faculty of Veterinary Medicine, University of Thessaly
Associate Professor A.Y.M. Fontbonne	École Nationale Vétérinaire d'Alfort
Assistant Professor A. Pourlis	Faculty of Veterinary Medicine, University of Thessaly
Assistant Professor H.N. Ververidis	School of Veterinary Medicine, Aristotle University of Thessaloniki

TABLE OF CONTENTS

	Page
ΠΕΡΙΛΗΨΗ	3
ΣΥΜΒΟΥΛΕΥΤΙΚΗ ΕΠΙΤΡΟΠΗ - ΕΞΕΤΑΣΤΙΚΗ ΕΠΙΤΡΟΠΗ	13
ABSTRACT	15
ADVISORY COMMITTEE - EXAMINATION BOARD	23
TABLE OF CONTENTS	24
GENERAL INTRODUCTION	27
Preface - Objectives of the thesis	28
Acknowledgments - Ευχαριστίες	29
CHAPTER I	32
REVIEW OF THE LITERATURE	
A. PRINCIPLES OF ANATOMY OF THE REPRODUCTIVE SYSTEM AND OF PHYSIOLOGY OF THE <i>PUERPERIUM</i> OF FEMALE DOGS	33
Principles of anatomy of the reproductive system of female dogs	33
Principles of physiology of the puerperium in female dogs	41
B. PATHOLOGICAL CONDITIONS OF FEMALE DOGS DURING THE <i>PUERPERIUM</i>	45
Systemic <i>post-partum</i> pathological conditions	45
<i>Post-partum</i> pathological conditions of the uterus	49
<i>Post-partum</i> pathological conditions of the mammary glands	58
C. OVARIO-HYSTERECTOMY DURING THE <i>PUERPERIUM</i>	64

CHAPTER II	66
RESEARCH WORK: MATERIALS AND METHODS	
Experimental overview - Animals	67
General clinical examination of experimental animals	69
Clinical and ultrasonographic examination of the genital system - collection of vaginal samples	69
Clinical and ultrasonographic examination of the mammary glands - collection of teat duct material and milk samples	72
Measurement of haematological and blood biochemical parametres	74
Measurement of blood serum progesterone concentration	75
Bacteriological and cytological examination of vaginal samples	75
Bacteriological and cytological examination of teat duct material and milk samples	76
Behavioural observations	77
Procedures for ovario-hysterectomy and mastectomy	81
Examination of the uterus and the ovaries - collection of samples	82
Examination of the mammary glands - collection of samples	83
Bacteriological and cytological examination of uterine content samples	83
Bacteriological examination of mammary parenchyma samples	84
Histological, histometric and ultrastructural examination of uterus, ovary and mammary parenchyma tissue samples	84
Data management	85
 CHAPTER III	 90
RESEARCH WORK: RESULTS	
General clinical findings in experimental animals	91
Haematological and blood biochemical parametres	92
Blood serum progesterone concentration	101
Clinical and ultrasonographic findings in the genital system	102
Bacteriological findings in vaginal samples	113
Cytological findings in vaginal samples	114
Clinical and ultrasonographic findings in the mammary glands	118
Bacteriological findings in teat duct material and milk samples	123
Cytological findings in milk samples	128

Behavioural findings	132
Gross appearance of the uterus and the ovaries	146
Bacteriological and cytological findings in uterine content samples	154
Histological, histometric and ultrastructural findings in uterus and ovary tissue samples	156
Gross appearance of the mammary glands	166
Bacteriological findings in mammary parenchyma samples	169
Histological, histometric and ultrastructural findings in mammary parenchyma tissue samples	169
CHAPTER IV	176
GENERAL DISCUSSION	
Introduction	177
Haematological and blood biochemical values during pregnancy and the <i>puerperium</i>	177
Blood serum progesterone concentrations during the <i>puerperium</i>	180
Features of the genital system during the <i>puerperium</i>	180
Features of the mammary glands during the <i>puerperium</i>	184
Patterns of maternal-offspring behaviour during the <i>puerperium</i>	188
Effects of litter size on the characteristics of the <i>puerperium</i>	190
Epilogue	191
REFERENCES	194

GENERAL INTRODUCTION

Preface - Objectives of the thesis

The *puerperium* starts with completion of parturition. During that period, the genital system progressively returns to the pre-gravid size and function, although differences exist between animal species in relation to the re-start of the ovarian activity. Moreover, the mammary glands become fully functional and, then, progressively involute as lactation advances.

In bitches, the *puerperium* has been studied little, especially if one takes into comparison the vast amount of information available for farm animals. Nevertheless, veterinary progress in carnivores requires increase of relevant knowledge, including more details for the *puerperium*. In fact, during that period, female dogs may develop various pathological conditions, some of which can be life-threatening for the animal. Their early diagnosis is paramount, as, for some of these disorders, immediate veterinary attention and initiation of treatment are required. Correct health management during the *puerperium* is important, as it will affect the re-start of ovarian activity and the start of a new oestrous cycle, which would lead to a new pregnancy. Moreover, correct health management is important for ensuring survival and growth of the puppies.

The present thesis focusses on the study of the *puerperium* of healthy female dogs, with the general objective to increase available knowledge regarding the normal *puerperium* of that species and to elucidate the process of involution of the uterus and the mammary glands in female dogs. Specific objectives of the thesis were as follows.

- A proposal of 'reference' values for haematological and blood biochemical parameters during the *puerperium*.
- The description of anatomical details and their progressive changes in the uterus and the mammary glands during the *puerperium*.
- The identification of time periods, during which the uterus and the mammary glands are more susceptible to infection.
- The identification of cells present in the uterine content and in the milk.
- The study of sucking behaviour during lactation and the identification of potential risk factors for mammary infections.

The present thesis has been carried out at the Department of Obstetrics and Reproduction of the Veterinary Faculty of the University of Thessaly. Research work started in 2006 and was carried out until the end of 2009; it was followed by analysis of results and writing up of the thesis. The thesis was financially supported by departmental funds.

Parts of the work described in the thesis were carried out in collaboration with the Department of Anatomy, Histology and Embryology, the Department of Physiology and the

Department of Medicine of the Faculty. Parts of the work were also carried out at the Department of Pathology and Infectious Diseases of the Royal Veterinary College (University of London), at the Institute of Infection and Global Health of the School of Veterinary Science, University of Liverpool and at the Department of Animal Production of the Technological Educational Institution of Epirus.

Acknowledgments - Ευχαριστίες

Ευχαριστώ ιδιαίτερα τον επιβλέποντά μου, καθηγητή κ. Γιώργο Χ. Φθενάκη, για την ευκαιρία που μου έδωσε να εκπονήσω μαζί του αυτή τη διατριβή σε ένα ζωικό είδος, το οποίο με ενδιέφερε ιδιαίτερα. Η συνεργασία με αυτόν ήταν για εμένα μία περίοδος, στην οποία απέκτησα πάρα πολλές γνώσεις, εφόδια και πολύτιμες εμπειρίες. Τον ευχαριστώ για την αμέριστη στήριξη και καθοδήγησή του, τη συνεχή βοήθειά του, την ικανότητά του να βρίσκει λύσεις στα φαινομενικά άλυτα προβλήματα, τις εύστοχες συμβουλές του και τη συνεχή εμπύχωσή του σε όλη τη διάρκεια εκπόνησής της διατριβής. Επίσης, τον ευχαριστώ θερμά για την εξασφάλιση οικονομικών πόρων, αναγκαίων και απαραίτητων για την πορεία της μελέτης και για την όλη οικονομική υποστήριξή μου. Είμαι ιδιαίτερα ευτυχής που είχα την τιμή να συνεργαστώ μαζί του στην αρχή της επαγγελματικής σταδιοδρομίας μου και πού με εμπιστεύθηκε στην ερευνητική δραστηριότητά του.

Ευχαριστώ τον καθηγητή της Κτηνιατρικής Σχολής του Αριστοτελείου Πανεπιστημίου Θεσσαλονίκης κ. Κ.Μ. Μπόσκο, για τη συμβολή του στην επιλογή του θέματος της διατριβής και για τις υποδείξεις του στη διάρκεια της εκπόνησής της. Επίσης, ευχαριστώ τον καθηγητή της Κτηνιατρικής Σχολής του Αριστοτελείου Πανεπιστημίου Θεσσαλονίκης κ. Ι.Α. Ταϊτζόγλου, ο οποίος ήταν από τους πρώτους ακαδημαϊκούς δασκάλους μου, για τη συμβολή του σε θέματα φυσιολογίας.

Ευχαριστίες επίσης απευθύνω:

Στον επίκουρο καθηγητή της Κτηνιατρικής Σχολής του Αριστοτελείου Πανεπιστημίου Θεσσαλονίκης κ. Χ.Ν. Βερβερίδη, για τη συνεχή βοήθειά του, τις υποδείξεις του, τις ιδέες του και τη συνεχή παροχή γνώσεων - τον ευχαριστώ ιδιαίτερα για την υπομονή που επέδειξε στην εκπαίδευσή μου, για την παροχή τεχνογνωσίας, για την συνεχόμενη παρουσία του σε καίρια σημεία της μελέτης, για την προθυμία του να βοηθά στα εκάστοτε προβλήματα και δυσκολίες και για τη συνεχή και πραγματική στήριξη και εμπιστοσύνη του.

Στον επίκουρο καθηγητή της Κτηνιατρικής Σχολής του Πανεπιστημίου του Liverpool κ. P.J. Cripps, για τη βοήθεια στη διαμόρφωση του πειραματικού σχεδιασμού, στη διαχείριση και τη στατιστική ανάλυση των δεδομένων της μελέτης.

Στον αναπληρωτή καθηγητή κ. Γ.Σ. Αμοιρίδη, για τη βοήθειά του σε θέματα κλινικής πράξης, συμβουλών και παροχής εξοπλισμού.

Στον επίκουρο καθηγητή του Τμήματος Κτηνιατρικής του Πανεπιστημίου Θεσσαλίας κ. Α. Πούρλη, για τη βοήθειά του στην ανατομική μελέτη του γεννητικού συστήματος και των μαστικών αδένων.

Στο συνάδελφο κ. Δ.Α. Γκουγκουλή, για τη συνεχή και πρόθυμη βοήθειά του σε θέματα ηθολογίας και ανάλυσης των ηθολογικών δεδομένων.

Στη συνάδελφο και επιστήθια φίλη κ. Η.Α. Φράγκου για τη σημαντική βοήθειά της και τη άψογη συνεργασία της κατά τη διάρκεια των δειγματοληψιών και των χειρουργείων στη διάρκεια της μελέτης, καθώς και για τη συνεχή βοήθεια και υποστήριξη.

Στη λέκτορα του Τμήματος Κτηνιατρικής του Πανεπιστημίου Θεσσαλίας κ. Λ.Β. Αθανασίου, για τη συνεργασία της, τη σημαντική βοήθειά της στην ανάλυση των δειγμάτων αίματος, την παραχώρηση εξοπλισμού και υλικών και την εξοικονόμηση πόρων.

Στη λέκτορα του Τμήματος Κτηνιατρικής του Πανεπιστημίου Θεσσαλίας κ. Ε. Βαλάση, για τη συνεργασία της και την πρόθυμη βοήθειά της σε θέματα φυσιολογίας.

Στην καθηγήτρια του Τμήματος Ζωικής Παραγωγής του Τεχνολογικού Εκπαιδευτικού Ιδρύματος Ηπείρου κ. Α. Τζώρα, για τη συμβολή της στις βακτηριολογικές εξετάσεις στη διάρκεια της μελέτης.

Στον αναπληρωτή καθηγητή του Τμήματος Κτηνιατρικής του Πανεπιστημίου Θεσσαλίας κ. Μ. Σαριδομιχλάκη, για την παραχώρηση χρήσης εξοπλισμού.

Στον καθηγητή του Τμήματος Ζωικής Παραγωγής του Τεχνολογικού Εκπαιδευτικού Ιδρύματος Ηπείρου κ. Ι. Σκούφο, για τη σημαντική βοήθειά του.

Στον αναπληρωτή καθηγητή του Τμήματος Κτηνιατρικής του Πανεπιστημίου Θεσσαλίας κ. Ι. Παππά, για την παραχώρηση χρήσης εξοπλισμού.

Στη συνάδελφο και φίλη κ. Χ.Μ. Νέρου, για τη σημαντική βοήθειά της σε θέματα αναισθησιολογίας και για τη συνεργασία της κατά τη διάρκεια των χειρουργείων της μελέτης.

Στους συναδέλφους κ.κ. Δ. Δούκα και Φ. Λυκοτραφίτη, για τη βοήθειά τους σε χρήση εξοπλισμού και παρασκευή διαλυμάτων.

Στο συνάδελφο κ. Σ. Μαυρίδη, για την παρασκευή διαλυμάτων απαραίτητων για την πορεία της μελέτης.

Στη συνάδελφο κ. Κ. Μαρίνου, για την βοήθειά της σε θέματα υπερηχοτομογραφικής εξέτασης του γεννητικού συστήματος και του μαστού.

Στην κ. S. Rodway της Βασιλικής Κτηνιατρικής Σχολής του Πανεπιστημίου Λονδίνου, για την παρασκευή δειγμάτων για την ιστολογική εξέταση.

Στην παρασκευάστρια του Τμήματος Ζωικής Παραγωγής του Τεχνολογικού Εκπαιδευτικού Ιδρύματος Ηπείρου κ. Κ. Φώτου, για την παρασκευή μικροβιολογικών υποστρωμάτων.

Στον κ. Α. Τρούκη και την κ. Φ. Ριζάβα, για τη φροντίδα των πειραματοζώων και τη βοήθειά τους στις δειγματοληψίες.

Τέλος, ένα μεγάλο 'Ευχαριστώ' σε όλα τα μέλη της οικογένειάς μου, που, με την αγάπη τους, τη συνεχή στήριξή τους, την υπομονή τους και την εμπιστοσύνη τους στις δυνατότητές μου, αποτελούν πάντα την αφετηρία να θέτω στόχους και να προσπαθώ για την επίτευξή τους.

CHAPTER I

REVIEW OF THE LITERATURE

A. PRINCIPLES OF ANATOMY OF THE REPRODUCTIVE SYSTEM AND OF PHYSIOLOGY OF THE *PUERPERIUM* OF FEMALE DOGS

Principles of anatomy of the reproductive system of female dogs

Introduction

The major function of the reproductive system is 'production' of offsprings and, in the long term, survival of the species. The female reproductive system is responsible for production of female sex hormones, development of female reproductive cells, provision of a hospitable environment for the embryos during pregnancy and delivery of the newborns. After parturition, the newborn puppies should be fed and cared for. Feeding of the puppies is achieved by milk produced by the mammary glands. Although the mammary glands are located under the abdominal skin, they are part of the reproductive system, because their function is vital for growth of the newborns, which ensures survival of the species (Colville 2002).

The genital system

In female dogs, the genital system is located in the abdominal and the pelvic cavity. It is consisted of the two ovaries, which produce female gametes and hormones, the two uterine tubes (oviducts), which transfer the female gametes to the uterus, the uterus, which provides the ideal environment for embryo development, the vagina, which is used as a birth canal, the vestibule, which terminates in the vulva and is used to connect the vagina to the vulva, as well as for urine passage, and the clitoris. The ovaries, the oviducts and a part of the uterus are located into the abdominal cavity; a part of the uterus and the vagina are located into the pelvic cavity (Figs I.1-I.3) (Dyce et al. 1996, Colville 2002).

The ovaries, the oviducts and the uterus are 'hanging' by broad sheets of peritoneum (the right and the left broad ligaments) from the dorsal part of the abdominal cavity, which are termed *mesovarium*, *mesosalpinx* and *mesometrium*, respectively. These ligaments contain blood vessels and nerves, which supply the respective organs. The mesovarium also includes attachments of the suspensory and proper ligament of the ovary. The suspensory ligament of each ovary attaches dorsocranially at the diaphragm and ventrocaudally at the ovaries; it is composed of longitudinal

smooth muscles, connective tissue, vessels and nerves. Near the ovary, the amount of the smooth muscles decreases, whilst adipose tissue increases. The proper ligament is a short, flat fibromuscular band on the dorsal aspect of the ovary extending from the apex of the uterine horn to the ovarian bursa sheath and to the ovary (Andersen and Simpson 1973).

The ovaries are located in the dorsal part of the abdominal cavity 1 to 3 cm behind the respective kidney and covered by the ovarian bursa (Johnston et al. 2001). They are small in size, ovoid and nodular (Schummer et al. 1979). In fat and older dogs, the ovarian bursa is covered by great amounts of adipose tissue (Johnston et al. 2001). The central part of the ovaries, known as stroma, is more loose and vascular. Blood supply to the ovary is provided by the ovarian artery (a branch of the aorta), primarily, as well as by the uterine artery; the ovarian artery is larger and responsible for the rich vascular net of the ovarian stroma (Schummer et al. 1979). Their peripheral part, the parenchymatous zone, is full of follicles in various stages of development or regression (Dyce et al. 1996). Each follicle contains a single ovum. After ovulation, the cavity within the ruptured follicle is initially filled with blood and, after that, by cells, producing a structure known as *corpus luteum*. The *corpus luteum* progressively regresses and is replaced by connective tissue, becoming the *corpus albicans* (Dyce et al. 1996). The ovaries produce the reproductive cells (ova), by the process of 'oogenesis', which is under hormonal regulation (oestrogens and progestins) (Colville 2002).

The uterine tubes (oviducts, fallopian tubes, salpinges) are small, narrow and convoluted muscled tubes, which extend from the edge of the uterine horns. Their free end, termed *infundibulum*, is located close to the cranial pole of the ovaries (near the edge of the ovarian bursa opening), but is not attached onto them. The tubular part is divided into two segments: the *ampulla* (proximal to the ovary) and the *isthmus* (more convoluted and narrow) (Schummer et al. 1979, Dyce et al. 1996). The *isthmus* is connected to the apex of the respective uterine horn, at the uterotubal junction, for prevention of leaks from the uterus back to the tube. The opening of the uterine tube into the horn of the uterus is termed the 'uterine ostium'. The tube's wall is consisted of external serosal, middle muscular (smooth muscle fibers) and internal mucosal tunics. The mucosa is folded longitudinally covered with movable cilia (Dyce et al. 1996), with the role to capture the ovum from the ovary by a small opening of the *infundibulum*, the 'abdominal ostium'. The uterine tubes provide the site for ovum fertilisation by spermatozoa and, then, the fertilized ovum is transferred to the uterus (Schummer et al. 1979, Colville 2002).

The uterus is a hollow, muscular, 'Y'-shaped organ, which consists of the cervix, the body and the horns. The uterus extends to the vagina caudally and the oviducts cranially. The uterine horns and the uterine body are located in the dorsal part of the abdominal cavity, hanging by the

mesometrium. In general, the uterine horns are longer than the uterine body, which is 1 to 3 cm long (Schummer et al. 1979). The wall of the uterus consists of a serous tunic, a muscular tunic (which includes the outer longitudinal layer of smooth muscle, the vascular layer and the inner circular layer of smooth muscle) and the mucosal tunic (which includes the lamina propria with blood vessels, the uterine glands and the epithelium), respectively termed 'perimetrium', 'myometrium' and 'endometrium' (Schummer et al. 1979, Dyce et al. 1996). The cervix of the uterus is a 1.5 to 2.0 cm-long, thick-walled structure, consisting of smooth muscles, with a narrow canal, located into the pelvic cavity, ventrally to the rectum and dorsally to the bladder (Johnston et al. 2001). It acts like a sphincter, which controls access to and from the vagina (Colville 2002). The cervical canal is constricted and filled by mucosal folds; it communicates caudally with the vagina by the external (vaginal) ostium and cranially with the uterine body by the internal (uterine) ostium. The size, the weight and the gross appearance of the uterus can vary, depending on breed, age, reproductive stage and parity of the animal.

The most independent role of the uterus begins with the introduction of the fertilised ovum. The fertilised ovum implants in the uterus and begins to develop. Gradually and whilst the embryo develops, the zonary type placenta is formed around it. Through the placenta, which is a life support system, the embryo is fed and its wastes are removed. The uterus provides the environment for the growth of the embryo and is growing along with development of the embryo. When development of the embryo has been completed, the uterine contractions and the simultaneous dilation of the cervix, under hormonal and neural regulation, help delivery of the puppies (Colville 2002). Immediately after parturition, the uterus contracts to stop haemorrhages from the placental sites and, in the long-term, to return to the pre-gravid state..

The vagina is a long (10-14 cm in non-pregnant bitches) and thin-walled, musculomembranous tube, which connects the cervix to the vulva. It is located in the pelvic cavity, ventrally to the colon and dorsally to the bladder and the urethra (Schummer et al. 1979). The intrusion of the cervix (*portio vaginalis*) into the cranial part of the vagina, may reach 0.5 to 1.0 cm, reduces the vaginal lumen, the remaining part of which is termed the *fornix*, extending ventrally and cranially to the cervix; for this reason, the vagina is considered to be 'bottled shaped' (Johnston et al. 2001). The caudal opening of the vagina, in the vestibule, is termed *ostium vaginae*. The dimensions of vagina increase during pregnancy and parturition. The gross appearance and the fine structure of the vaginal mucosa change during the various reproductive stages of the bitches (Johnston et al. 2001). During the pro-oestrus, when concentrations of blood serum oestrogens are increased, the mucosa appears like oedematous pink or pink-white folds. In late pro-oestrus, as concentrations of serum oestrogens decrease, there is progressive shrinkage of the folds with

withdrawing of fluid retention effect and increase of mucosal density and palor. During oestrus, when concentrations of blood serum progesterone increase, the mucosa looks dense and white with sharp folds. At the end of the oestrous period and at the onset of the dioestrus, the mucosa stops shrinking, becoming thin with round folds. During dioestrus, the mucosa is hyperhaemic and sensitive. These changes may be best detected by means of vaginal cytological smears (Johnston et al. 2001). The role of the vagina is to receive the penis at mating and act like a birth canal during whelping (Colville 2002); in fact, the vaginal lumen is mostly shrunked, except during mating and whelping times.

The vestibule is the caudal part of the reproductive tract, positioned caudally to the ischial arch, like hanging from it, extending cranially to the vagina and caudally, after a short slope, to the vulva. Usually, it is half the length of the vagina. On the ventral floor of the vestibule, near the vaginovestibular junction, appears the external urethral orifice. The vaginovestibular junction presents some resistance to manipulations (Johnston et al. 2001), but relaxes during oestrus to accept insertion of the male genital organ. On the epithelium of the vestibule, there are the entrances of the vestibular glands, which, in bitches, are small and numerous, with their orifices in a line (Dyce et al. 1996); their role is to produce a mucous secretion, necessary for lubrication of the vestibule during mating and parturition, as well as stimulating male animals during oestrus.

The vulva is the only visible part of the female reproductive tract. It consists of the two labiae (right and left) that meet at the dorsal and ventral commissures. The dorsal commissure is rounded and the ventral is pointed, covered by a transverse fold formed from the skin of the perineum. These labiae are homologous to the (inner) *labiae minora*e in humans. Inside the ventral commissure is located the clitoris, the female homologous of the penis. It is formed of the two crura, stemmed from the ischial arch and covered by muscles, the body and the glans, which is the free end of the clitoris. The mucous membrane of the vestibular floor forms a fold, which covers the glans and forms a cavity. The fold is termed the prepuce of the clitoris and the cavity is termed the fossa of the clitoris. In female dogs, the crura and the body of the clitoris consist of adipose tissue. The prepuce of the clitoris is homologous of the prepuce of the male dog. (Dyce et al. 1996).

Figure I.1. Diagram of the genital tract of female dogs (modified from Colville 2002).

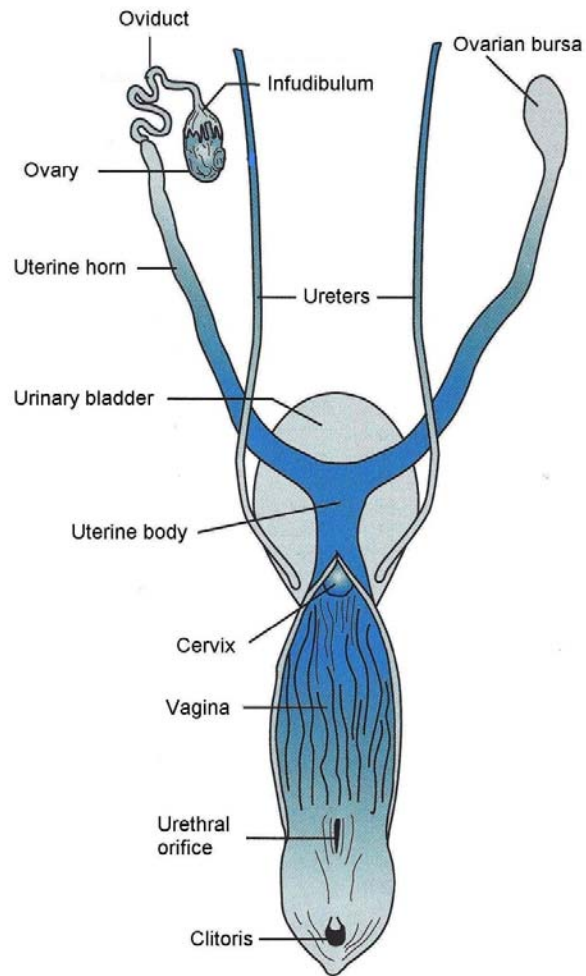

Figure I.2. Diagram (lateral view) of the genital tract of female dogs (modified from Colville 2002).

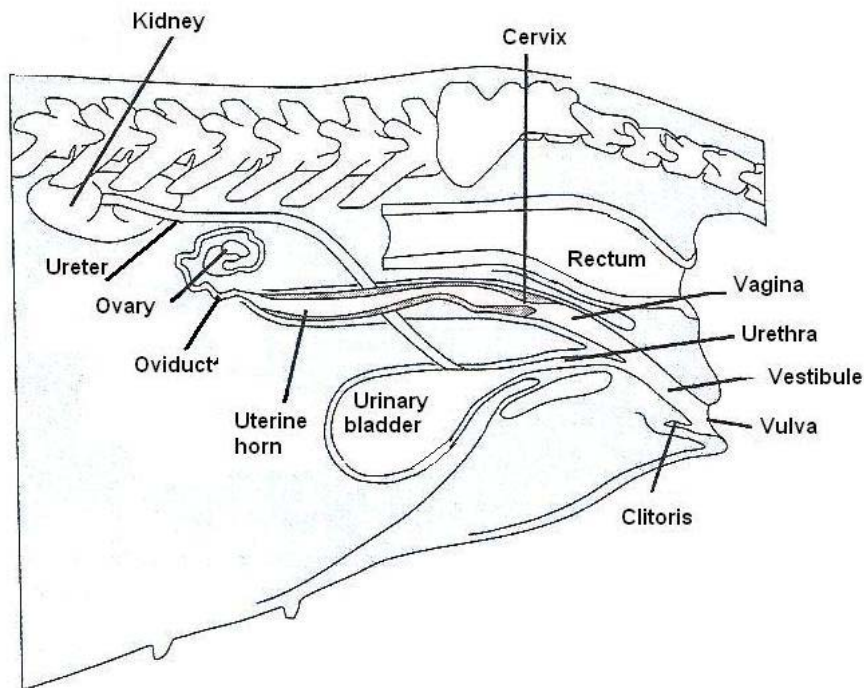
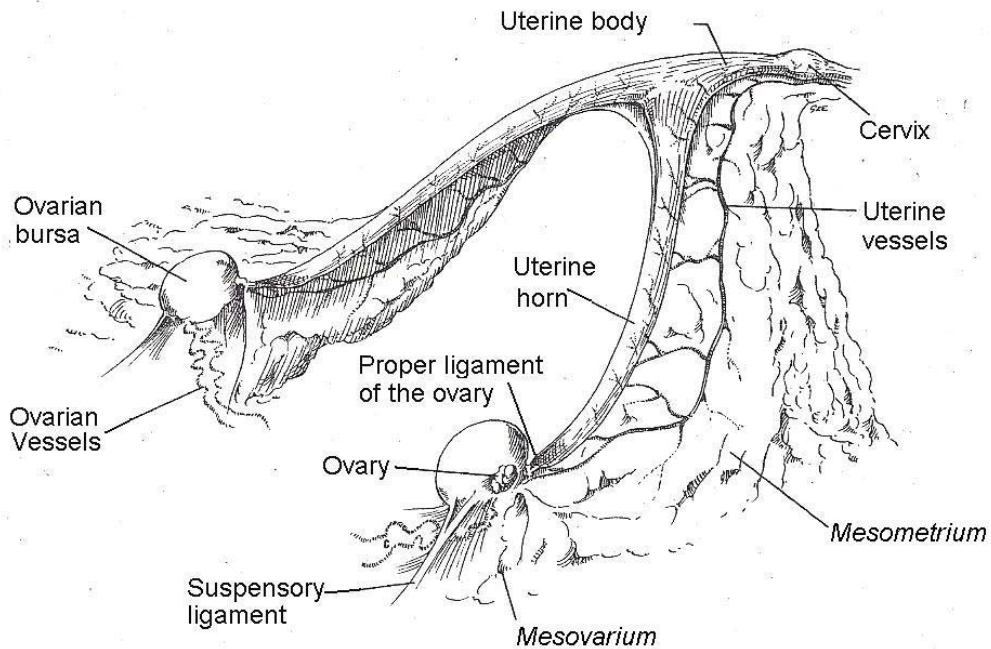

Figure I.3. Diagram (lateral view) of the ligaments of the genital tract of female dogs (modified from Stone 2003).



The mammary glands

The mammary glands are modified sweat glands, covered by the skin (Figs I.4 and I.5). They are arranged into two symmetrical rows, parallelly (left and right) to the median line of the body. In bitches, the number of mammary glands can vary from 8 to 12. The mammary glands extend from the thoracic to the inguinal area, thus characterised as thoracic, abdominal or inguinal mammary glands (Schummer et al. 1979, Barone 2001). The number of ducts opening on a teat varies between 7 and up to 22 ducts per teat (Christensen 1979, Evans and Christensen 1993). The most cranial thoracic mammary glands drain into the axillary lymph nodes. The caudal thoracic mammary glands and the abdominal mammary glands drain into the axillary, the cranial sternal lymph nodes and the superficial inguinal. The inguinal mammary glands drain into the superficial inguinal lymph nodes (Schummer et al. 1981, Johnston et al. 2001).

During pregnancy (especially after mid-pregnancy), the mammary glands increase in size, which reaches its peak during lactation, when they produce colostrum (during the first few days after whelping) and milk.

The milk-secreting units of each mammary gland are the alveoli. Each alveolus is a small, sack-like structure that produces milk and secretes it into a small duct, the alveolar duct. Around each alveolus, there are the spindle-shaped, contractile myoepithelial cells (Silver 1966). The myoepithelial cells contract under the stimulus of oxytocin and help to forward the milk from the lumen of an alveolus into small ducts. These small ducts join to form larger ducts and, then, even larger ones, the primary lactiferous ducts. Each lactiferous duct ends on the base of the teat, where a spindle-shaped distention is formed, the lactiferous cistern (Schummer et al. 1979, Michael 1996, Barone 2001). Within each mammary gland, the lactiferous cisterns are separated between them by connective tissue. Each lactiferous cistern opens at the inner end of a teat duct, which occupies approximately one-third of the length of the teat (Silver 1966). The tunica propria of the teat duct contains connective tissue, blood vessels, smooth muscle and elastic fibers; each teat duct is presented with circular smooth muscle fibers, possibly acting as sphincters (Silver 1966). At the other end of the teat duct, the teat orifice, milk is expressed during sucking by puppies (Colville 2002). Length of the teat, which projects abruptly from the mammary parenchyma, is 10 to 12 mm (Schummer et al. 1979, Barone 2001).

Figure I.4. Diagram of an alveolus and duct system in the mammary gland of female dogs (modified from Silver 1966).

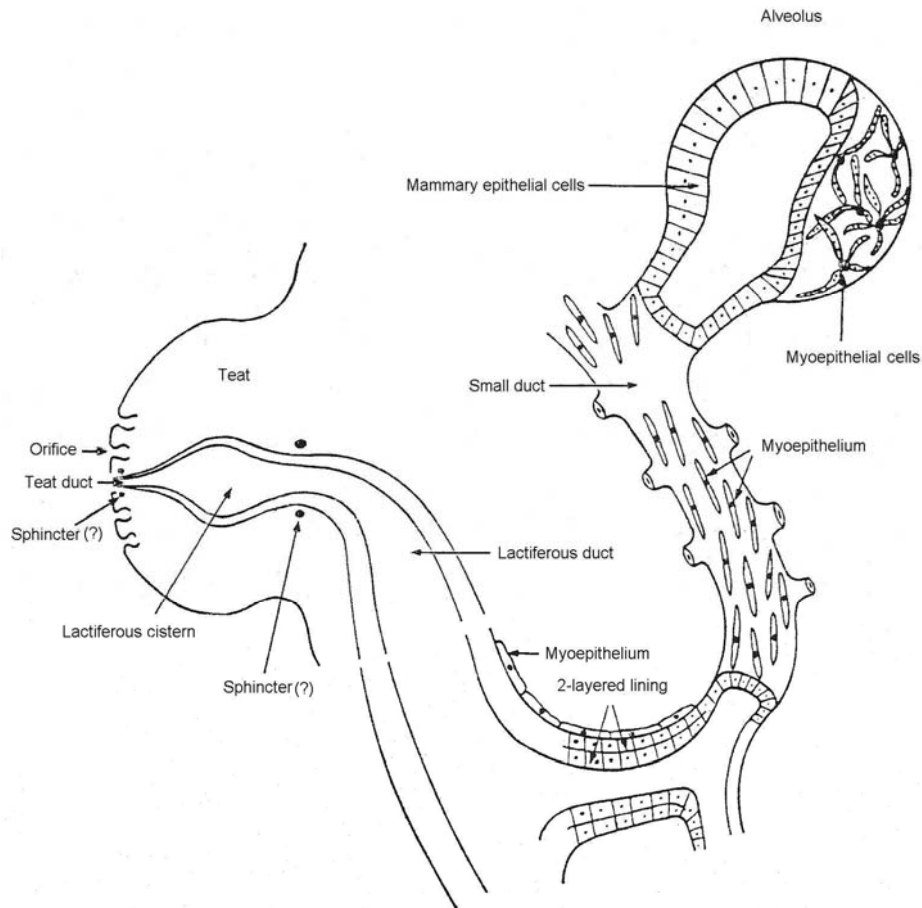
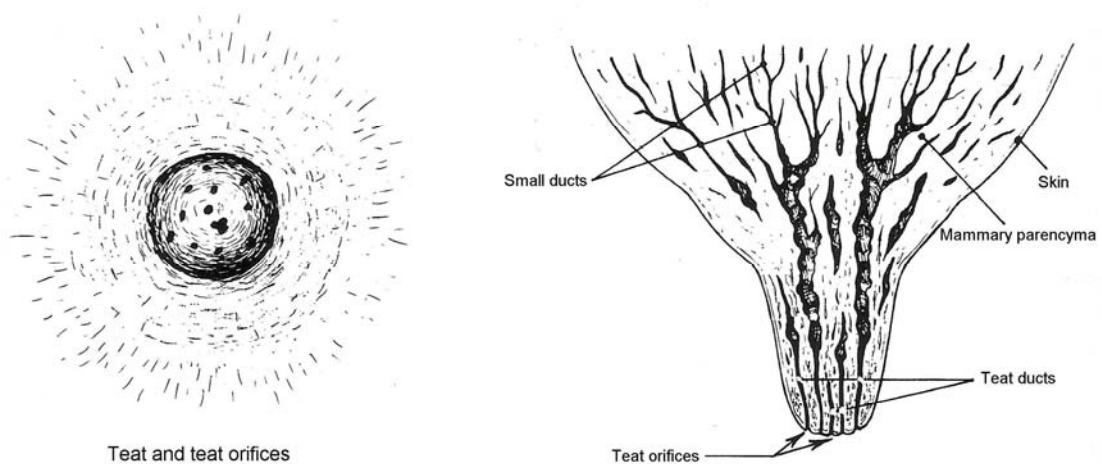

Figure I.5. Diagram of the teat orifices and the mammary gland of female dogs (modified from Barone 2001).



Principles of physiology of the *puerperium* in female dogs

Endocrinological changes

In female dogs, the *puerperium* is primarily under the influence of prolactin and oxytocin (i.e., hormones directly associated with lactation). In contrast, luteinising hormone (LH) and follicle-stimulating hormone (FSH) are in basal concentrations. Similarly, progesterone concentration does not exceed 2 ng mL⁻¹. Concentrations of oestrogens vary; a possible increase would not be associated with signs of oestrus, but only with transient changes in cytological findings in vaginal smears (Knight et al. 1977, Concannon et al. 1978, Fieni et al. 1999, Johnston et al. 2001).

Prolactin is produced by the lactotroph cells of the anterior lobe of the pituitary gland, which controls milk production and regulates maternal behaviour. Its concentration in the blood increases sharply before whelping, from 41 ng mL⁻¹ to 117 ng mL⁻¹, and remains increased throughout the *puerperium* (Concannon et al. 1978). Prolactin production does not have a circadian pattern (Gobello et al. 2001) and a decrease of its concentration is associated with a reduction in milk production (Jochle 1997). As lactation advances, its concentration progressively decreases; five weeks after whelping, its concentration was found to be <20 ng mL⁻¹ and two weeks later <10 ng mL⁻¹ (Graf 1978).

Oxytocin is synthesized in the hypothalamus and stored in the posterior lobe of the pituitary gland, whence it is released into the blood circulation, as a result, primarily, of sucking by the newborns. It is responsible for milk let-down from the mammary glands and contributes to uterine involution by promoting uterine motility. It also causes contraction of myoepithelial cells of the mammary glands, resulting to exit of milk into the *sini lactiferi* of the mammary glands and finally let-down of milk. Its concentration in blood is increased throughout lactation (Kustritz 2005). Johnston and others (2001) have found that, as a result of continuous oxytocin secretion during lactation, no exogenous administration of the hormone was necessary for uterine involution. Concentrations were found to progressively decrease as puppies grow, started consuming dry-feed and, consequently, reduced the sucking frequency (Debraeckeeler et al. 2000). Moreover, oxytocin can promote social interactions, including maternal behaviour (Pedersen and Prange 1979, Agriolas and Gessa 1991, Witt et al. 1992). However, expression of maternal behaviour in response to oxytocin requires a previous exposure to oestrogens and, of course, presence of offspring. Oxytocin also promotes development of a dam-offspring bond, as has been extensively shown in farm animals (Kendrick et al. 1987, Carter 1992) and modifies maternal behaviour, as demonstrated in women (Nissen et al. 1998).

Finally, Steinetz and others (1987) reported presence of relaxin in small concentrations in the blood of lactating bitches. During the first week of the *puerperium*, that was found to be $>0.6 \text{ ng mL}^{-1}$, progressively decreasing to the basal concentration ($<0.4 \text{ ng mL}^{-1}$) five weeks after whelping.

Changes in the genital system

In bitches, whelping is followed by an anoestrous period, the beginning of which coincides with the *puerperium*. During the *puerperium*, the *corpora lutea* of pregnancy are regressing and are transformed to '*corpora albicantia*', the size of which is progressively reduced. At whelping, the *corpora lutea* have a diameter of $\sim 4.0 \text{ mm}$, whilst three months later the *corpora albicantia* have a diameter of $\sim 2.5 \text{ mm}$ (Noakes 2001). The *puerperium* mainly refers to the uterine involution, achieved with contractions of the myometrium. Contractions last for only a few days after whelping and aim to expel all fluids and residual tissues from the uterus, as well as to reduce bacterial numbers in the genital tract. For a period of three to four weeks, lochea are discharged from the genital tract in progressively reduced quantities. During the first week after whelping, their quantity is copious, but thereafter their quantities are reduced and are discharged sporadically. Immediately after whelping, canine lochea have a characteristically green colour, due to presence of uteroverdin. Twelve hours after whelping, the genital discharge becomes muco-haemorrhagic (Noakes 2001).

The size of the vulva and the diameter of vagina return to normal progressively and within four to six weeks. The size of the uterus decreases progressively, with full reduction of the size of the uterus taking place within the next two months (Ferri et al. 2003), although restoration of histological structure requires at least three months after whelping (Al-Bassam et al. 1981b). Simultaneously with the above changes, regeneration of the endometrium also takes place during the 12 weeks after whelping. Placental sites can be seen for at least four weeks after whelping, as lumps symmetrically arranged on the uterine horns (Noakes 2001). Caesarean section does not appear to affect the progress of *puerperium* (Ferri et al. 2003).

Changes in the mammary glands

Changes in the canine mammary glands, dependent upon the stage of oestrous cycle of female dogs, have been described by Rehm and others (2007). Those authors have described the histology of the mammary glands in immature female dogs, as well as in bitches during dioestrus or anoestrus; they did not describe the histological features of mammary glands of lactating bitches. In general, there are few descriptions of the lactating mammary glands of female dogs.

Andersen and Simson (1973) have mentioned that initial development of the mammary glands takes place at around the 35th day of the first pregnancy; 10 days later, they are well-developed. Mammary development continues after whelping; 14 days after it, the mammary glands reach their maximum development. At that point, the alveoli are distended and the mammary epithelial cells are flattened. Lacteal secretions can be observed in the alveolar lumen. Milk secretion is maintained as long as the sucking stimulus is present. Progressively, mammary parenchyma is replaced by connective tissue and adipose tissue, whilst inflammatory cells infiltrate the involuting glands and the size of the alveoli is reduced. Finally, the mammary glands take a morphology of inactivity (Banks 1993).

Behavioural changes

Maternal behaviour is regulated by oxytocin and prolactin (Whitman and Albers 1995) and depends upon genetic and hormonal factors. The experience from previous whelpings, as well as olfactory, visual and auditory stimuli from the newborn puppies play an important role. Maternal behaviour is also affected by the health of the female animal and her puppies, the environment, the animal-owner relationship and the breed of the animal.

Usually, female dogs have a strong maternal instinct. The last week before whelping, they select and prepare a relatively isolated area ('nest'), in order to pre-arrange care for their puppies. During the course of whelping and up to its completion, they usually do not allow sucking by the newborns (Kustritz 2005). In any case, the newborn puppies must suck within the first 8 to 12 hours after birth to increase survival probabilities. Usually, bitches place the newborns on the teats, in order to facilitate sucking. After sucking, they would groom the abdomen of their puppies, in order to instigate urination and defaecation. These behavioural patterns take place up to the third week after whelping (i.e., a period during which newborns have restricted mobility). Thereafter, the frequency of sucking is reduced, as consumption of solid feed starts progressively (Kustritz 2005). Early separation of puppies from their dam has been associated with increased incidence risk of

infections and increased mortality of newborns and has not been found to afford advantages in socialisation of the young dogs (Slabbert and Rasa 1993). In general however, behavioural patterns in dogs during the *puerperium* have not been studied extensively.

B. PATHOLOGICAL CONDITIONS OF FEMALE DOGS DURING THE *PUERPERIUM*

The disorders of the *puerperium* can be classified as follows: systemic disorders (puerperal hypocalcaemia, abnormal maternal behaviour), disorders of the uterus (*post-partum* metritis, uterine prolapse, retention of foetal membranes or fetuses, subinvolution of placental sites, puerperal haemorrhage) and disorders of the mammary glands (mastitis,agalactia, galactostasis).

Systemic *post-partum* pathological conditions

Puerperal hypocalcaemia

Puerperal hypocalcaemia (eclampsia, puerperal tetany) can occur in the final stages of pregnancy or, more frequently, immediately after whelping, at which stage calcium requirements of a bitch are increased due to milk production. Cases occur more frequently in animals of small-size breeds, which suckle a high number of puppies (Burke 1977, Drobatz and Casey 2000); these are often associated with peak milk production (i.e., between the second and the fourth week of the *puerperium*). In some rare cases, the disease may occur even after 40 days *post-partum* (Wheeler et al. 1984).

The largest proportion (99%) of calcium in animals is present in the bones. Remaining calcium can be found in cell membranes and the endoplasmic reticulum (0.9%), as well as in extracellular fluids and blood serum (0.1%) (Rossol et al. 1995). In extracellular fluids and blood serum, calcium is present as biologically active ionised calcium (50%), anion-bound calcium (5%) and protein-bound calcium (45%) (Rossol et al. 1995). Hypocalcaemia occurs due to the combination of increased calcium requirements and reduced calcium availability, which is the consequence of reduced calcium intake (primary aetiology) or reduced absorption from the intestine / mobilisation from the bones (secondary aetiology). In cases of hypocalcaemia, there is increased permeability of the cell membrane of neurons, which leads to a lower threshold for depolarisation (Capen 2004). Thus, neurological signs are caused by continuous, repeated depolarisation of neurons.

At the early stage of hypocalcaemia, which may not be detected by the animal owner, affected animals are restless, dyspnoeic and crying; they develop excess salivation and itching of the head. Usually, the condition deteriorates quickly. At that stage, neurological signs, such as tetanic posture, mydriasis and seizures, may develop (Thebault 2005). Then, high fever ($>40.5\text{ }^{\circ}\text{C}$) and signs of cardiac dysfunction (arrhythmia) become evident, so death can be imminent (Capen 2004). Even after a seemingly successful treatment, seizures may reoccur up to three weeks after the first signs (Drobatz and Casey 2000).

Clinical diagnosis is based in history (*post-partum* period, high calcium requirements) and clinical findings. Confirmation depends on the results of biochemical tests: total calcium concentration in blood serum is $<8\text{ mg dL}^{-1}$ (Austad and Bjerkas 1976, Kaufman 1986, Drobatz and Casey 2000). In general, total calcium concentration in blood serum correlates with that of ionised calcium. Nevertheless, in cases of hypoproteinaemia when the proportion of protein-bound calcium is reduced, the following formulae can be used for accurate calculation of total calcium concentration: $CT_{Ca}=(T_{Ca}-T_{ALB})+4$ (Sodikoff 2001) or $CT_{Ca}=(T_{Ca}-[0,4\times T_{TP}])+3.3$ (Meuten et al. 1982), where CT_{Ca} : corrected total calcium concentration, T_{Ca} : calcium concentration (mg dL^{-1}), T_{ALB} : albumin concentration (g dL^{-1}), T_{TP} : total protein concentration (g dL^{-1}).

Differential diagnosis includes seizures of other aetiology (e.g., hypoglycaemia, meningoencephalitis), as well as toxicoses with neurological signs (e.g., caffeine-, strychnine-, lead-, metaldehyde-poisoning) (Johnston et al. 2001).

Measurement of glucose concentration in blood is necessary for differential diagnosis between hypocalcaemia and hypoglycaemia. One should note that, occasionally, glucose concentration in hypocalcaemic bitches may be smaller than normal, due to the intense muscular contraction (Kaufman 1986). Phosphorus and magnesium concentrations are within the normal ranges.

Treatment should start immediately based on history and clinical findings, even without waiting for laboratory confirmation. Treatment includes administration of 10% calcium gluconate or borogluconate intravenously at 3 to 20 mL ($5\text{-}15\text{ mg kg}^{-1}$ bodyweight [bw]), depending on the severity of the clinical condition. Calcium administration should be slow (up to 1 mL min^{-1} and completed within 10 to 20 min); it should be interrupted if cardiac arrhythmia, severe bradycardia or vomiting occurs. Usually, response to treatment is immediate. Following that, calcium should be administered subcutaneously (same total amount, divided into two equal quantities at different sites of the body, in order to minimise potential irritant effects of calcium). Subcutaneous administration should be repeated every 24 hours (Wallace and Davidson 1995) or even more frequently (e.g., every 6 to 8 hours), depending on recurrence. One should note that some cases of hypoglycaemia

respond to administration of calcium gluconate or borogluconate, because gluconates can contribute partially to energy requirements of the animal. Nevertheless, in cases of confirmed hypoglycaemia intravenous administration of 10 to 20% dextrose solution at a dose of 5 to 20 mL is preferred. Administration of glucocorticoids is contra-indicated, because they reduce calcium absorption from the intestine and increase excretion in the urine (Johnston et al. 2001) and do not contribute to improvement of the animal's condition.

After improving and stabilising the general condition of the animal, calcium should be given *per os*, specifically calcium carbonate or calcium gluconate (50 mg kg⁻¹ bw, twice daily) or bicalcium phosphate (125 mg kg⁻¹ bw, thrice daily), as well as vitamin D (10000-25000 iu, daily) (Kaufman 1986, Boscós and Samartzi 1996). In any case and in order to achieve quick clinical recovery, puppies should be removed from their dam for 12 to 24 hours. In cases of relapsing disease, they should be permanently taken away from the affected bitch. In that case, cessation of lactation can be achieved by using prolactin-inhibitors (e.g., cabergoline [2.5-5 µg kg⁻¹ bw, daily, *per os*, for 4-6 days], metergoline [0.2 µg kg⁻¹ bw, daily, *per os*, for 4-8 days] or bromocryptine [10 µg kg⁻¹ bw, daily, *per os*, for 10 days]) (Bastan et al. 1998). Furthermore, care should be taken for the newborn puppies (Hoskins 1995, Gouletsou et al. 2002).

Prevention of the disease is best achieved by feeding a balanced diet during pregnancy and the *puerperium*. Ideally, the calcium:phosphorus ratio therein should range from 1:1 to 1.2:1 (Martin and Capen 1980). Usually, commercially available dog feeds of type 'high energy for adult dogs' or 'puppy growth' fulfil these requirements. Preventive administration of calcium during pregnancy does not seem to benefit the animals. In contrast, it may cause reduction in parathormone production and thus predispose rather than prevent the disease (Boscós and Samartzi 1996, England 1998). However, animals which have been sick in previous *post-partum* periods, should receive calcium *per os* starting immediately after whelping; there is more scope for this, if an affected bitch has a large litter. Furthermore, owners should be informed regarding the possibility that their animal may develop the disorder and they must be alert for immediate veterinary care.

Abnormal maternal behaviour

Various factors causing nervousness, pain or disturbance of bitches, which include various disorders (especially in cases of eclampsia, metritis or mastitis [Kustritz 2005]), a hostile environment, frequent visits from unknown people and attempts to foster puppies, can lead to abnormal maternal behaviour. This behaviour becomes evident with abandonment of puppies, with rejection of puppies or even with cannibalism (Kustritz 2005). Other factors leading to abnormal maternal behaviour are genetic predisposition, caesarean section, inexperience of the dam and even the puppies themselves if they were crying continuously (Linde-Forsberg 2005). Moreover, a dam may choose to neglect puppies with abnormalities (i.e., subnormal bodyweight, cleft palate) or ill-health (Boscós and Samartzi 1996, England 1998). Although the selecting behaviour is considered to be abnormal, one may suggest that the dam, by sacrificing some puppies, attempts to guarantee the survival of the other puppies (Kustritz 2005). There are occasions that the dam herself can harm her own puppies; examples include ulcerations in the feet from excessive grooming (England 1998) or evisceration from umbilical chewing (Boscós and Samartzi 1996). Finally, neglect of the whole litter is usually a consequence of a pathological condition in the dam.

In such cases, puppies should be removed from their dam temporarily and until her behaviour returns to normal. Subsequently, they may be placed with her again, in order to evaluate her attitude. If she would continue to show abnormal behaviour, puppies should be removed from her (Boscós and Samartzi 1996). In that case, prolactin-inhibitors should be administered to affected bitches, in order to stop milk production.

For prevention of abnormal behaviours, the parturient bitch should be allowed to select the whelping area ('nest') in a quiet place. Only people, whom she may accept, should come in contact with her. The animal must be observed discreetly, but regularly, in order to detect early signs of nervousness resulting from external stimuli and to recognise aggressive behaviour early. After a caesarean section, the puppies are placed next to their dam, with fresh the odour of foetal fluids. Administration of sedatives should be avoided, because their effects in lactating animals have not been fully evaluated. Finally, females which have shown abnormal maternal behaviour in the past, must be closely monitored after subsequent whelpings to recognise abnormal behaviours and to protect the newborns. In cases of repeated abnormal behaviour, the animals should be excluded from reproduction.

***Post-partum* pathological conditions of the uterus**

Post-partum metritis

Post-partum metritis usually develops in acute form, one to four days after whelping, and is characterised by inflammation of the endometrium and myometrium (Wheeler et al. 1984). The disease is caused by intrauterine bacterial invasion through the open cervix during or immediately after whelping. The most frequent aetiological agents of the disorder are *Escherichia coli* (~65% of cases), *Proteus* spp., *Staphylococcus* spp. and *Streptococcus* spp. (Magne 1986, Wykes and Olson 1993).

Predisposing factors include those which (i) can contribute to bacterial invasion into the uterus (dystocia and obstretical manipulations, vaginitis, whelping in a dirty environment), (ii) allow for long-standing dilatation of the cervix (whelping of long duration, delayed involution of the uterus) or (iii) support intra-uterine bacterial growth (abortion, retention of foetuses or foetal membrane) (Burke 1977, Boscós and Samartzi 1996, Linde-Forsberg 2005).

Exit of increased quantity of viscous, brownish, malodorous secretion from the genital tract is a salient clinical feature of the disease (Burke 1977, Magne 1986, Johnston et al. 2001). Frequently, the disorder is accompanied by retention of foetal membranes or foetuses, in which case the discharge becomes dark grey to black. During palpation through the abdominal walls, the uterus is found to be distended, usually giving a foamy feeling due to gases therein (Burke 1977). Occasionally, the disease co-exists with mastitis. There are some cases of *post-partum* metritis, in which there is no genital discharge, especially in incidents of obstruction of the genital tract, due to a retained foetus or uterine torsion or uterine rupture and peritonitis.

Post-partum metritis may lead to systematic disease. Usually, fever (40-40.5 °C) or, at a later stage, hypothermia (Magne 1986), depression, dehydration, anorexia, tachypnoea, tachycardia and vomiting are the usual clinical signs. The animal neglects her puppies and has a decreased milk production or even complete agalactia (Magne 1986, Linde-Forsberg 2005). Severe cases of the disease, in which treatment would not start on time, can result to death of the animal, consequently to septicaemia or toxaemia.

When genital discharge is present, clinical diagnosis is easy, based on the development *post-partum* and the clinical picture. Various paraclinical tests may be used to evaluate the severity of the animal and to promote successful treatment.

Microbiological examination of vaginal discharge (culture, susceptibility testing) is required for isolation and identification of the causative agent, as well as for evaluation of susceptibility to

antimicrobial agents. Microscopic examination of Giemsa-stained discharge films usually reveals presence of lysed neutrophils, microorganisms and red blood cells, as well as epithelial cells from the endometrium (Johnston et al. 2001). The results of haematological tests indicate increased proportion of immature neutrophils, coupled with leucocytosis or in severe cases with leucopenia (Burke 1977, Johnston et al. 2001). As a consequence of the dehydration, haematocrit values and total protein concentrations in blood may be increased (Magne 1986, Linde-Forsberg 2005). Also, there may be increased values of creatinine and/or blood-urea-nitrogen in blood (Magne 1986). Urine examination is not recommended, because catheterisation or cystocentesis may lead to urinary infection or uterine injury, respectively. Furthermore, the findings (e.g., increased specific gravity of urine, bacterial isolation from urine) are not particularly helpful in reaching a diagnosis.

X-ray examination is important, in order to exclude the possibility of retention of foetuses or foetal remnants and for the evaluation of the degree of uterine distension, as well as to assess presence of potential peritonitis (Boscós and Samartzi 1996). Ultrasonographic examination of the uterus is particularly useful in cases of conservative treatment, in order to assess the distension of the uterus and the quantity and texture of the uterine content, as well as to assess the response to treatment.

The differential diagnosis includes subinvolution of placental sites, puerperal uterine haemorrhage and other disorders with similar clinical signs.

Instigation of treatment must take place immediately after diagnosis. Treatment includes elimination of infection by emptying uterine content or by removing the uterus, as well as general support of the animal. Success depends upon timely instigation of treatment, severity of disease and general health status of the animal. Frequently however, in spite of early initiation of treatment, the animal may succumb (Boscós and Samartzi 1996).

Treatment starts with rehydration of the animal and administration of electrolytes. If the condition of the animal would allow, an ovario-hysterectomy may be attempted, unless the owner wants the animal for further breeding. However, there are no reports regarding the possible effects of metritis on subsequent reproductive activity of the animal. If the disease coincides with retention of foetal membranes or foetus(es) or if there is a risk of uterine rupture, ovario-hysterectomy should be performed immediately (Magne 1986, England 1998).

Conservative treatment (after restoration of fluid and electrolyte balance) includes administration of antibiotics and ecbolic agents. Injectable broad-spectrum antibiotics should be administered (Boscós and Samartzi 1996, England 1998), followed by *per os* administration for 10 to 14 days. The following scheme has been recommended for administration: oxytocin (5-20 iu, intramuscularly, every 8 hours) followed by ergovine (0.2 mg 15 kg⁻¹ bw *per os*, every 8 hours for 2-

3 days), in order to support exit of uterine content (Magne 1986, Boscós and Samartzi 1996). Oxytocin has increased safety margin over ergovine, but is effective only during the first three to four days after whelping (Magne 1986, Johnston et al. 2001). If the general condition of the animal would allow, one may also administer prostaglandin F_{2a} (dinoprost, 0.025-0.1 mg kg⁻¹ bw, 6-8 times daily for 2-3 days or, alternatively, 0.1-0.25 mg kg⁻¹ bw 1-2 times daily for 3-8 days) (Linde-Forsberg 2005). Gabor and others (1999) proposed the direct intravaginal administration of prostaglandin F_{2a} (0.15 mg kg⁻¹ 1-2 times daily for 4-12 days). One should be aware that prostaglandin, as well as all other ecboic agents, may predispose to uterine rupture (Magne 1986, Boscós and Samartzi 1996), especially if the uterine wall is already friable, as in cases of retention of foetal membranes or foetus(es), severe infection or accumulation of gas. Therefore, these drugs should be administered with care. It is also noteworthy that prostaglandin F_{2a} may cause various adverse reactions to bitches (e.g., abdominal pain, tachycardia, tachypnoea, salivation, vomiting) 10 minutes to 2 hours after administration.

The response of the female dog to treatment should be monitored ultrasonographically. A successful treatment course is characterised by reduction in uterine size and decrease in the amount of uterine content, coupled with improvement of the clinical picture of the animal. Intra-uterine infusion of antiseptic or antimicrobial agents is contra-indicated, because it can lead to uterine rupture or to impaired phagocytic ability of intra-uterine neutrophils (Johnston et al. 2001). Furthermore, these agents may be irritant for the endometrium, potentially leading to subsequent subfertility of the animal (Johnston et al. 2001).

Uterine prolapse

Uterine prolapse, with eversion of one or both horns, is a rare disorder. Usually, it occurs during whelping or immediately thereafter, when the cervix is still open. The disorder is termed 'full prolapse', when the prolapsing part of the uterus protrudes through the vulva or 'partial prolapse', when it remains in the vagina and can only be detected by digital palpation (Wood 1986, Boscós and Samartzi 1996, England 1998, Nak et al. 2005). The disorder may be caused after forceful traction of foetus(es) or foetal membranes, as well as in case of severe tenesmus during metritis or retention of foetal membranes (Wood 1986).

Clinically, the disorder is characterised by the appearance of uterus through the vulva or, in case of partial prolapse, by frequent tenesmus, as a consequence of which a partial prolapse may become full prolapse. The prolapsing part of the uterus may be congested, oedematous or even necrotic. Possible complications include uterine injury, uterine infection (Wood 1986), rupture of

vessels leading to haemorrhage (England 1998), or even, in severe cases, death (Boscós and Samartzi 1996).

Diagnosis relies in history and clinical findings. If uterine horn(s) is(are) seen through the vulva, the diagnosis is easy, because on the protruding mass one can observe placental sites. For the diagnosis of partial prolapse, one should consider the following: history of recent whelping, presence of vaginal discharge, intense and frequent tenesmus, restlessness of the animal and possible intermittent prolapse through the vulva, and, mainly the findings of digital vaginal examination and/or vaginoscopy (Wood 1986, Boscós and Samartzi 1996). The prolapsing part of the uterus should be evaluated for injury, vessel rupture or necrosis.

The differential diagnosis should include vaginal or uterine neoplasms, metritis, retention of foetal membranes and oedema-prolapse of vaginal mucosa.

Objective of the treatment is to replace the uterus in its normal anatomic position; this depends upon the severity and chronicity of the prolapse, the state of the uterine wall and the general condition of affected bitches. In case of shock, the animal's condition should be stabilised before attempting replacement of the uterus. Epidural anaesthesia facilitates manipulations (Boscós and Samartzi 1996).

If the condition of the uterus (recent prolapse with healthy tissue and only mild oedema of the uterus) would allow replacement, the prolapsing part of the uterus and the external genitalia are thoroughly washed with a mild antiseptic solution. Replacement takes place *per vaginam*, concurrently with manipulations through the abdominal walls (Wood 1986). The animal is restrained on the forelimbs and the part of the uterus nearer the vulva is pushed towards the vagina (Boscós and Samartzi 1996). After a possible successful replacement of the greater part of the uterus, infusion of sterile normal saline into the uterus supports full replacement (Boscós and Samartzi 1996). Digital vaginal examination and palpation of the uterus through the abdominal wall can be used to assist and confirm replacement (Wood 1986).

If *per vaginam* manipulations fail, replacement can be effected after pulling the uterus to the normal anatomic position through laparotomy (Boscós and Samartzi 1996, England 1998). If there are injured or necrotic areas in the uterus, ovario-hysterectomy or uterine amputation, depending on the extent of the lesion, are recommended immediately after successful replacement.

Replacement is followed by intramuscular administration of oxytocin (5-10 iu once), in order to support uterine involution and to prevent a new prolapse. Depending on the severity of the case, antibiotics may also be administered.

Retention of foetal membranes or foetuses

Retention of foetal membranes in bitches is a relatively rare disorder. During a normal whelping, delivery of each foetus is followed by exit of the respective foetal membranes, usually within 5 to 15 minutes (Johnston et al. 2001). Successive delivery of two to three foetuses followed by simultaneous exit of the respective foetal membranes may also be observed (Boscós and Samartzi 1996).

In case of retention of foetal membranes, there is dark green, grey or black-coloured discharge (England 1998) for over 12 hours *post-partum* (Boscós and Samartzi 1996). The discharge becomes evident within the first few days after whelping; unless the retention is dealt with immediately, it may lead to metritis and subsequent septicaemia (Hirt et al. 2000, Linde-Forsberg 2005). In uncomplicated cases, part of or the entire foetal membranes remain attached to the placental sites for weeks or even months after whelping, the only clinical finding being a continuous or intermittent discharge of a small quantity of greenish mucous. Occasionally, the discharge stops or may not be noticed by the owner of the animal.

A similar type of discharge is observed in cases of foetal retention. Usually, the condition leads progressively (within hours or days) to uterine infection with severe *post-partum* metritis coupled with foetal emphysema. The discharge becomes purulent and malodorous and other signs of *post-partum* metritis become evident. Usually, the uterus contains a large quantity of thick fluid, within which the disintegrated foetuses can be seen. In cases not treated properly, further complications, such as uterine rupture, peritonitis and septicaemia can be observed. Such cases require ovario-hysterectomy, repeated peritoneal washings and intensive care of the animal (Ritt and Fossum 1997), whilst the prognosis is poor. However, long-standing foetal retention after dystocia without development of endometritis or any other complication has also been reported (Ververidis, Stamou et al. 2007), but seems to be rare.

Foetal retention may also occur after an unsuccessful attempt to inhibit oestrus in a bitch by inappropriate use of long-acting progestagens. When administered during late pro-oestrus or oestrus, these drugs do not inhibit ovulation, mating, conception and pregnancy (Ververidis et al. 2003) and furthermore, may delay labour for 5 to 40 days. Consequently, foetal death and retention may occur. In such cases, the thick, dark green discharge, characteristic of the condition, becomes evident when the cervix of the uterus dilates at the end of the period of activity of the progestagens.

Clinical diagnosis is easy when foetal membranes or foetuses are detected in the vaginal lumen. The retained foetal membranes or foetuses may be felt by palpation of the uterus through the abdominal wall. However, size of the animal and uterine involution may influence the findings (Linde-Forsberg 2005). One should take into account that in the early stages of the *puerperium*,

one may occasionally feel an engorgement at the site of uterine bifurcation. In any case of dark green genital discharge, the possibility of retention of foetal membranes or foetuses should be considered.

X-ray examination confirms or refutes foetal retention (foetal skeleton can be clearly visible) and provides details regarding the size and position of the uterus. In case of dead foetus(es) and depending upon the duration of retention in the uterus, the foetal skeleton is imaged in abnormal posture or decomposed, findings which are not present in living foetuses. Therefore, X-ray of the abdomen is recommended to confirm completion of labour, especially if there is a suspicion of foetal retention (Feeney and Johnston 2002). However, X-ray examination is not useful for diagnosis of retention of foetal membranes.

During ultrasonographic examination, dead foetuses are imaged with increased echogenicity and a blurred structure, whilst in live foetuses one can detect cardiac function. The foetal membranes are imaged as inconsistent structures of increased echogenicity within the uterus. However, they cannot be clearly distinguished from accumulations of blood and debris normally present within the uterus *post-partum* (Peter and Jakovljevic 1992, Pharr and Post 1992, England et al. 2003).

It may be possible to confirm the diagnosis by comparing the number of newborn puppies to that of expelled foetal membranes. In that case, one should take into account that finding of fewer foetal membranes than newborn puppies can be consistent with consumption of some foetal membranes by the parturient bitch or, more rarely, with birth of monozygotic twins (Boscós and Samartzi 1996).

For treatment of retention of foetal membranes, oxytocin (1-5 iu, 2-3 times daily for at least 3 days) is recommended (England 1998, Linde-Forsberg 2005). Foetal membranes detected in the vagina can be pulled with mild manipulations, by taking special care to avoid infection or rupture of the genital tract (Boscós and Samartzi 1996). The manual expulsion can be supported by manipulation of the uterus through the abdominal wall, from the horns to the vagina (Linde-Forsberg 2005). In case of foetal retention, hysterotomy and surgical removal of the foetuses or even ovario-hysterectomy is indicated. When the uterus is not removed, *post-partum* metritis should be prevented by administering broad-spectrum antibiotics and ecbolic drugs.

Subinvolution of placental sites

It is generally believed that subinvolution of placental sites is the consequence of the erosion of the uterine wall from trophoblastic remnants. These do not degenerate, but remain and

erode the glandular layer of the endometrium, sometimes invading the myometrium (Boscós and Samartzi 1996, Johnston et al. 2001). This defect may affect one or, usually, more placental sites. The disorder occurs more frequently in primiparous bitches (Wheeler 1986, Johnston et al. 2001), but no breed predisposition has been reported (Johnston et al. 2001).

Clinically, a small quantity of continuous or intermittent haemorrhagic or mucohaemorrhagic vaginal discharge is detected for over one month after whelping. Occasionally, the discharge may be evident up to the subsequent pro-oestrus (Johnston et al. 2001).

In most cases, the general health of the animal is not affected and no abnormal haematological or biochemical features are evident. In very few cases, there is a sudden deterioration of the animal's health, coupled with increased quantity of haemorrhagic discharge (likely as a consequence of erosion of uterine vessel). One or more nodule-like structures exist along the horns, not easily felt during abdominal palpation due to their soft consistency. During ultrasonographic examination, hypoechogenicity areas with a large diameter (~1.5 cm, depicting subinvoluting placental sites) alternating with areas of increased echogenicity with smaller diameter (~1.0 cm, depicting interplacental areas). Hypoechogenic content may also be detected in the uterine lumen. However, even with ultrasonography, differential diagnosis between normal uterine involution and subinvolution of placental sites cannot be secured. During X-ray examination, the uterus cannot be imaged due to its small size. Vaginal smears usually reveal many red blood cells, a few mature neutrophils, epithelial cells of the endometrium and trophoblast-like cells (Wheeler et al. 1984, Dickie and Arbeiter 1993, Linde-Forsberg 2005).

Complications, like uterine infections or rupture of the subinvoluting placental sites, are rare (Linde-Forsberg 2005). Subsequent fertility of the animals does not seem to be affected (England 1998), although others reported that the genital tract, even after clinical restoration, could be predisposed to various disorders (Arbeiter and Dickie 1993).

Histological examination may reveal large amounts of connective tissue, haemorrhages and extended uterine glands at the placental sites. Dimensions of these may be even double than normal. Presence of trophoblast residues forming syncytia in the myometrium is characteristic of the disorder (Al-Bassam et al. 1981a, Fernandez et al. 1998).

Diagnosis relies on the presence of a small quantity of haemorrhagic discharge for over six weeks after whelping (Tejerina and Vega 1995) and the normal size of the uterus as estimated by abdominal palpation in an otherwise healthy animal. Diagnosis can further rely on the ultrasonographic findings, the cytological findings in vaginal smears or even the histological examination of uterine tissue samples (Johnston et al. 2001).

The differential diagnosis includes other disorders with haemorrhagic vaginal discharge, like metritis, coagulation disorders, ehrlichiosis, brucellosis, injuries, infections and neoplasms of the lower genital tract, as well as signs of subsequent pre-oestrus/oestrus. Therefore, the vagina should be fully examined by means of vaginoscopy, digital palpation and cytological examination of vaginal smears.

In most cases, the disorder recedes without treatment (Burke 1977, Wheeler 1986), the latest until the beginning of the next oestrous cycle. If the animal owner would not be interested about future breeding of the animal, ovario-hysterectomy may be suggested. Otherwise, spontaneous recession of the clinical signs is awaited, while the animal should be regularly monitored for potential infections or haemorrhages. Various therapeutic protocols have been proposed, but do not offer any significant advantage; these include administration of prostaglandin F_{2a} (Johnston et al. 2001), of ecbolic agents and antibiotics or of oxytocin (Wheeler et al. 1984). The administration of progestagens, although effective by supporting cervical closure, is discouraged, because it can predispose to metritis. Treatment can also include antimicrobial agents to prevent infection.

Puerperal haemorrhage

Puerperal haemorrhage occurs more often in animals with coagulation disorders. Rarely, it can be the result of erosion of large blood vessel(s) in case of subinvolution of placental sites. It may also be due to uterine rupture (Linde-Forsberg 2005), to venereal neoplasms (Boscós and Samartzi 1996) or to vaginal injuries (Linde-Forsberg 2005).

In contrast to normal animals, in which there is sporadic exit of a very small quantity of blood (a few drops) only during the first few days after whelping,

in the case of puerperal haemorrhage there is continuous exit of copious amount of fresh blood or blood clots (England 1998, Linde-Forsberg 2005). Depending on the aetiology of the syndrome, there are also other clinical signs.

Diagnosis is based on the characteristic clinical picture. One should further identify the principal underlying disorder. Further examinations should be performed, in order to assess the general condition of the animal. Haematological examination is important, to evaluate the haematocrit value, the number and the type of leucocytes and the number of thrombocytes. It is also important to check the haemostatic profile of affected bitches by measuring parameters, such as bleeding time, coagulation factors, prothrombin time, partial thromboplastin time etc. The vagina should be always checked thoroughly for potential injuries or neoplasms.

Treatment of cases of mild haemorrhage includes administration of oxytocin (5-20 iu, intramuscularly) or ergonovine (0.2 mg 15 kg⁻¹ bw, *per os*) (Boscós and Samartzi 1996, England 1998) and the general support of the animal. Usually, soon after administration of the oxytocin or ergonovine, one can see the discharge of a large quantity of blood, which refers to blood already accumulated in the uterus. This may lead to a false impression that the general health of the affected dog is deteriorating (Boscós and Samartzi 1996, England 1998). In cases of severe haemorrhage, a general supportive treatment with fluids and electrolytes and possibly, depending of the severity of the disorder, colloids and/or blood transfusion, should be undertaken. When the animal's condition is stabilised, ovario-hysterectomy should be performed (Linde-Forsberg 2005). In every case, the underlying primary disorder should be also treated.

Post-partum pathological conditions of the mammary glands

Mastitis

Mastitis is a disease of bacterial aetiology caused mainly by *E. coli*, *Staphylococcus* spp. (*S. aureus*, *S. pseudintermedius*, coagulase-negative Staphylococci) or *Streptococcus* spp. (Wheeler et al. 1984, Kuhn et al. 1991, Johnston et al. 2001, Jung et al. 2002, Linde-Forsberg 2005). The disease develops in one or more mammary glands of lactating bitches, more frequently immediately after the death or weaning of puppies during mammary involution. Bacteria enter into the mammary glands, most usually through the teat duct. The possibility of mammary infection through scratches or injuries of the skin (Boscos and Samartzi 1996) or even haematogenously (Linde-Forsberg 2005) has been reported.

Various factors, including dirty, hot and humid environment, mammary congestion immediately after whelping, injuries of the teats, small litter size, early (before 5th week *post-partum*) or abrupt removal of puppies from an affected bitch, severe stress of the animal (stressful and/or long whelping process, malnutrition etc.) and presence of metritis, have been reported as factors predisposing to the disease (Boscos and Samartzi 1996, Linde-Forsberg 2005).

Usually, the disease has an acute course and can be life-threatening (Dernell and Kreeger 1992). The general condition of the animal changes and can show inappetance, restlessness, fever (>40 °C) and indifference for the puppies (Wheeler et al. 1984). Affected mammary glands are painful, hot, enlarged and oedematous. Mammary secretion becomes thick, yellow, green, red or brownish and frequently contains flakes or clots (Wheeler et al. 1984, Linde-Forsberg 2005). Abscesses may develop in the parenchyma of the affected mammary glands. More rarely, necrosis may develop in a part of the affected mammary gland, consequently leading to sloughing off.

In long-standing or subclinical cases of mastitis, no severe clinical signs are evident. One may suspect the disease, if puppies do not appear to suck often, look hungry and do not thrive (Olson and Olson 1986, Linde-Forsberg 2005). Sometimes, the disease may lead to septicaemia and death of the neonates (Sager and Remmers 1990, Schäfer-Somi et al. 2003, Schäfer and Breitenfellner 2006). In long-standing mastitis, the mammary gland may appear shrunken. In other cases, fibrous tissue develops in the affected mammary glands and can be palpated as small (0.5-2 mm) hard nodules. Some of these can cause a recrudescence of the disease, with signs of acute mastitis in the subsequent lactation or in cases of pseudopregnancy.

There is only one experimental study of mastitis in bitches described in the international literature and the results are presented in detail herebelow (Ververidis, Mavrogianni et al. 2007).

The right caudal abdominal mammary gland of six animals was inoculated on the 8th day after whelping with *S. pseudintermedius* to induce mastitis; adjacent mammary glands were used as controls. Clinical examination, bacteriological and cytological (Whiteside Test, Giemsa) examination of mammary secretion, as well as haematological tests were performed from 5 days before until 34 days after challenge. Mastectomy was sequentially performed 1, 2, 4, 18, 26 and 34 days after challenge in each of the experimental bitches, in order to carry out a pathological examination of mammary glands. All animals developed clinical mastitis: challenged glands became painful, hot, enlarged and oedematous; secretion was brownish, purulent, with flakes or clots, subsequently becoming yellowish and thick. Staphylococci were isolated from all inoculated glands (up to 22 days after challenge). The Whiteside Test was positive in 41/46 samples from inoculated glands and 66/138 samples from control glands; neutrophils predominated during the acute stage. Blood leucocyte counts increased, whilst thrombocyte counts decreased. Gross pathological findings initially included congestion, purulent discharge and subcutaneous oedema; then, abscesses, brownish areas and size decrease were seen. Salient histopathological features were initially neutrophilic infiltration and haemorrhages, followed by destruction of mammary epithelial cells and alveoli, and, in later stages, infiltration by lymphocytes, shrunken alveoli, loss of glandular architecture and fibrous tissue proliferation. The researchers concluded that in dogs, intramammary inoculation of *S. pseudintermedius* could induce clinical mastitis, followed by subclinical disease. The disorder was characterized by bacterial isolation and leucocyte influx in the challenged glands, by leucocyte presence in adjacent mammary glands, by increased blood leucocyte counts and by destruction of mammary parenchyma.

Diagnosis of clinical mastitis is easy, based on the signs. Bacteriological examination of mammary secretion is useful to isolate and identify the aetiological agent. This would help to choose the appropriate antimicrobial drug for treatment. Acute mastitis should be differentiated from galactostasis, injuries and dermatitis in the area of the mammary glands (common during lactation), as well as from inflammatory-type mammary tumours. In cases of chronic mastitis, clinical differentiation of mammary nodules from similar findings in neoplastic mammary lesions is not easy. For the diagnosis of subclinical mastitis, the only reliable method is the combination of bacteriological and cytological examination. The Whiteside test was found to be reliable in detecting presence of increased number of leucocytes in milk (Ververidis, Mavrogianni et al. 2007). Five drops of fresh mammary secretion (~0.1 mL) are deposited on a clean glass slide and, then, two drops of 1 N NaOH solution are added. The mixture is swirled by using a bacteriological wire. The resulting clot formation is scored according to Schalm and others (1971). Additionally, secretion films can be made by directly smearing 20 µL from each sample on a microscope

objective plate and stained by the Giemsa method. The percentage of the various leucocyte subpopulations may be determined by distinguishing types present in the films. Measurement of haptoglobin concentration in serum samples, has also been reported as a potential diagnostic test for subclinical mastitis (Dzieciol et al. 2006).

Treatment should start immediately after diagnosis and should include systemic administration of antimicrobial agents for at least 7 to 10 days. The results of bacteriological examination of mammary secretion and of antimicrobial susceptibility testing, if available, can support administration of the appropriate drug. Otherwise, one should administer broad-spectrum antimicrobial agents (Wallace and Davidson 1995, Orfanou et al. 2009). If there would be no improvement of the condition of the animal within three days, the treatment regime should be modified. In order to choose the most appropriate antibacterial agent, one should also take into account that antibiotics are excreted in the milk and, therefore, uptaken by the puppies. Hence, administration of tetracyclines, fluoroquinolones and chloramphenicol is contra-indicated, as these drugs may cause various adverse reactions in puppies (Johnston et al. 2001).

Non-steroid anti-inflammatory drugs may be used as adjunct to the antimicrobial treatment, in order to reduce fever, mammary oedema and pain during acute mastitis and consequently to provide relief for the animal. There are no specific reports in the literature regarding their use in canine mastitis; however, their efficacy in the control of mastitis in ruminants has been documented (Dascanio et al. 1995, Fthenakis 2000, Mavrogianni et al. 2004, Smith 2005).

Treatment also includes the care about puppies of the affected animal. In cases of mild mastitis, in which composition of milk has not been altered and the general condition of health of the animal has not been affected, newborns can continue to suck their dam normally. In more severe cases, involving one or two mammary glands, cover-up of the affected glands (in order to stop sucking from those gland) would be adequate. In very severe cases, newborns should be removed from affected bitches and special care should be taken for artificial feeding (Hoskins 1995, Gouletsou et al. 2002). In such cases, the secretion of the affected mammary glands should be removed regularly; compresses should also be applied. If an abscess develops in an affected mammary gland, it should be opened. If there is extensive tissue necrosis, one may also perform surgical cleaning and debridement of the mammary tissue. When systemic signs are present, general support of the animal should be applied (Johnston et al. 2001). Finally, prolactin-inhibitors should be administered in order to stop lactation.

Treatment of long-standing mastitis is more difficult, because, in such cases, there would be no satisfactory diffusion of the antimicrobial drugs into the mammary gland. Diffusion depends on lipophilicity and pH of each antimicrobial agent; erythromycin, iodide penethamate, clindamycin and

lincomycin are antibiotics with suitable pharmacokinetic properties in the mammary gland (Ziv 1980). For selection of the appropriate antibiotic, the causal agent of the disease and the results of susceptibility testing should also be taken into account.

Agalactia

Agalactia is defined as unavailability of milk from the dam, either because of lack of milk production or because of impaired let-down to the *ducti lactiferi* and the teats. The disorder can be of primary or secondary aetiology (Johnston et al. 2001). Primary agalactia is rare and is due to absence of various anatomical structures of the mammary gland, which leads to problems of synthesis, secretion or let-down of milk. Secondary agalactia is the consequence of inadequate prolactin secretion, reduced responsiveness of teat receptors to tactile stimuli or of increased stress, resulting to malfunctioning milk let-down reflex (Johnston et al. 2001). Secondary agalactia develops after premature whelping, in cases of stressed bitches, during various pathological conditions (e.g., metritis, septicaemia), after progestagen administration, in cases of hormonal imbalance or even after inadequate nutrition of the pregnant animal (Wheeler et al. 1984). Temporary agalactia may also develop after administration of sedatives or anaesthetics. Primiparous bitches may also develop temporary agalactia in the immediately *post-partum* period, usually as a consequence of fear or nervousness (Olson and Olson 1986, Johnston et al. 2001). According to Olson and Olson (1986), cases of 'true' agalactia are those related to anatomical problems of the mammary gland or to hormonal imbalance of the animal, in contrast to cases of impaired milk let-down. 'Complete agalactia' and 'hypogalactia' are distinguished depending on the quantity of milk produced (Lorin 1975).

Suspicion of the disease may arise if the puppies are nervous and crying. The disease can be diagnosed based on clinical examination of the mammary glands of the animal. The examination would reveal improper development of the mammary glands and/or impaired milk let-down by the animal. Ideally, the examination should be performed at least one hour after withdrawal of the puppies from an affected bitch and 5 to 10 minutes after oxytocin (2 iu) administration.

Treatment includes control of possible *post-partum* systemic or reproductive disorders, in conjunction with neuro-hormonal stimulation of milk synthesis, secretion and let-down. It is effective only in cases of full development of the mammary glands (secondary agalactia). Treatment also depends on the identification and correction of the aetiological factor causing the disorder. Subcutaneous or oral administration of metoclopramide (0.1-0.5 mg kg⁻¹ bw, every 6-8 hours, for 5

days) supports prolactin production (Linde-Forsberg 2005). Furthermore, administration of oxytocin (0.5-2 iu, at least 8 times per day, for 1-5 days) (Davidson 2003) causes contraction of myoepithelial cells and milk let-down and is thus beneficial. In cases of nervousness, phenothiazines (acetylpromazine, *per os*, 1-2 mg kg⁻¹ bw) can also contribute; these drugs also support prolactin secretion, as they are dopamine antagonists. Continuous presence of the owner is also encouraged, especially in cases of nervous, primiparous bitches (Johnston et al. 2001), unless of course the owner him/herself is a stress factor for the animal. In every case of agalactia, due care should also be taken for feeding the puppies of the affected animal. These should be encouraged and supported to regular (10-15 minutes after oxytocin administration) teat-seeking and sucking until the disorder subsides. It is noteworthy that after sustained attempts, secondary agalactia can be resolved and normal milk production can start even after 3 to 4 days *post-partum*.

Galactostasis

Galactostasis refers to delayed or difficult let-down of milk, which results to its accumulation into the mammary glands. Usually, it is the consequence of anatomical problems in bitches, which impede exit of milk. It may also be observed after death of a puppy or abrupt weaning of puppies, as well as when puppies cannot take up all the available quantity of milk, (e.g., in litters with small number of puppies) (Johnston et al. 2001).

The mammary glands, more frequently the inguinal pair, become oedematous and enlarged (Linde-Forsberg 2005). The skin of the inguinal area is stretched and the animal shows signs of discomfort and local pain. Exit of milk is difficult or even impossible. Galactostasis may accompany or progress to mastitis (Johnston et al. 2001), as milk accumulating into the mammary glands is an excellent substrate for bacterial growth.

It is noteworthy that some degree of galactostasis occurs even after normal weaning of the puppies. However, as under natural conditions, weaning takes place progressively over a period of days or weeks, the condition does not have obvious clinical manifestations. Furthermore, intermittent and usually subclinical galactostasis develops in cases of a small litter and refers mainly to those mammary glands that are sucked little or not at all.

The differential diagnosis includes bacterial mastitis (in which case other signs of inflammation are present) and primary or secondary agalactia (in which case no mammary enlargement is present).

Treatment of galactostasis includes mild massage of the mammary glands, in order to achieve partial exit of milk and relief of the glands. In animals, which are not suckling puppies, the

administration of prolactin inhibitors is indicated. Furthermore, the quantity of feed and water should be reduced. Possible administration of diuretics may be beneficial to reducing mammary oedema (Wheeler et al. 1984).

C. OVARIO-HYSTERECTOMY DURING THE *PUERPERIUM*

During the *puerperium*, ovario-hysterectomy can be performed for treatment purposes or as a programmed neutering method. The technique should be modified appropriately, depending upon possible presence of an uterine disorder and/or the stage of the *puerperium*, taking into account the size of the uterus and the mammary glands, as well as of their blood vessels.

Pre-operatively, it is important to perform a haematological examination of the animal and to evaluate its hepatic and renal function. These tests are necessary in order to have a general evaluation of the animal in cases of impairment of the general condition, due to post-parturient disorders (e.g., metritis, puerperal haemorrhage).

During the first three weeks *post-partum*, the uterus has a large size and large vessels (Ferriet al. 2003), therefore sufficient surgical expertise and appropriate secure ligations are required. For the genital tract, a tight ligature at a previously clamp-crushed site of the cranial part of the vagina can be placed (England 2001), always combined proximally with ligatures of the uterine vessels. Alternatively, an inverted closure of the uterine body or the vagina by means of a Parker-Kerr or a Cushing ligature can be performed, always coupled with ligation of the lateral uterine vessels; in general, the cervix should be avoided (Toombs and Clarke 2003).

At a more advanced *post-partum* stage, when the uterus has further involuted, the operation can be performed with increased safety, according to the general principles of genital surgery (England 2001, Stone 2003, Hedlund 2007). However, even up to three months *post-partum*, the uterine wall (particularly at the placental sites) is delicate and may be over-crushed when compressed by clamps or by very tight ligatures (e.g., modified Miller's knot) (Hedlund 2007). It is preferable to avoid excessive compression of uterine tissue during clamp placement and to apply a mildly tight surgeon's knot at the crushed uterine tissue, always combined with ligatures of the lateral uterine vessels, proximally. Alternatively, the proximal vagina can be used to place a tight ligature at a previously clamp-crushed site, always combined with ligatures of the uterine vessels, adjacent to the cervix. For the proper approach to the anterior part of the vagina, the midline abdominal incision has to be extended and the urinary bladder adequately evacuated (Hedlund 2007).

When ovario-hysterectomy is performed in the early *post-partum* period for therapeutic reasons, the uterus is usually enlarged, with friable wall, septic uterine content (e.g., in case of metritis or foetal retention) and occasionally gas-distended. In such cases, the danger of uterine rupture and escape of content into the abdominal cavity is present, thus careful handling is needed.

The midline abdominal incision is extended for an unhindered extraction of the uterus and approach to the anterior part of the vagina. After release of the ovaries and uterine horns from the *mesovarium* and the *mesometrium*, but before handling the distended uterine body and vagina, the urinary bladder is evacuated and the anterior surgical field is covered with laparotomy sponges, over which the uterus is placed (England 2001). Two (or more) long haemostatic clamps are transversely placed; one at the caudal limit of uterus, the other at the anterior limit of the vagina (Stone 2003). The last and most critical section is planned between these clamps and safety distance should be maintained to avoid their slipping. Bilaterally to each clamp, small haemostatic clamps are placed for temporary vessels' occlusion and to aid stability of the long haemostatic clamps. The genital tract is incised between the clamps, just caudally to the cervix (often indiscernible when distended) with simultaneous sponging of any content leaks and the uterus is removed. The remaining vaginal stump is swabbed clean and ligated at the previously clamp-crushed site or inverted with a Parker-Kerr or Cushing suture, always combined with sutures of the lateral uterine vessels (England 2001, Stone 2003, Toombs and Clarke 2003).

In cases of peritonitis, repeated washings of the abdominal cavity (2 to 6 L of warm normal saline) should be performed after the ovario-hysterectomy. Depending on the severity of the condition, it would be wise to allow for drainage and to perform subsequent washings for a few days (England 2001). Affected animals should be placed under intensive management, with administration of fluids and electrolytes for up to three days and of broad-spectrum antibiotics for 10 to 15 days. A small quantity of clear, straw-coloured, odourless, aseptic fluid, containing only a few cells can be detected into the peritoneal cavity (in the absence of signs of peritonitis), of some bitches during ovario-hysterectomy performed soon after whelping.

In lactating animals, it may be preferable to postpone a scheduled ovario-hysterectomy for 15 to 20 days after weaning of puppies. This would contribute to adequate mammary involution and shrinkage of mammary vessels. However, if the operation is considered to be urgent and must be undertaken in a lactating animal, the following procedures should be taken during surgery: avoidance of injuries to the mammary glands, careful haemostasis of cut mammary vessels, continuous suture of subcutaneous tissue, intradermal suture in the incision (Hedlund 2007). Milk production is not affected after ovario-hysterectomy. However, in cases of severe ill-health of bitches, suckling of puppies is contra-indicated. If the puppies have been removed or have died, steps should be taken to stop milk production.

CHAPTER II

RESEARCH WORK:

MATERIALS AND METHODS

Experimental overview - Animals

In total, 12 pre-pubertal, Beagle-breed female dogs were purchased from an animal colony in Italy (Stefano Morini s.a.s, S. Polo D' Enza, Italy), which breeds dogs specifically for experimental work, and used in the study. The work was carried out under a licence for experimental procedures obtained from the Hellenic Ministry of Agriculture. Conditions prescribed by legislation of the European Union in relation to animal experimentation procedures (Council Directive 86/809/EEC), were followed during this work.

Appropriate vaccinations were performed to the animals against *Canine Distemper Virus*, *Canine Adenovirus 2*, *Canine Parvovirus*, *Canine Para-Influenza Virus*, *Rabies Virus*, *Leptospira canicola* and *L. icterohaemorrhagiae* (EURICAN DHPPi2-L[®] or EURICAN DHPPi2-LR[®]; Merial, Lyon, France). Anthelmintic treatments were performed appropriately, with praziquantel + pyrantel (Drontal Plus[®]; Bayer, Leverkusen, Germany), pyrantel (Banminth[®]; Pfizer, NewYork, NY, USA) and milbemycin (Milbemax[®]; Novartis, Basel, Switzerland). Fipronil (Frontline[®]; Merial, Lyon, France) was used for prevention of ectoparasite infestations.

The animals were mated during their first oestrus.

During the study, animals were housed in individual pens (1.5x3.0 m); equidistant to three sides of the pen, there was a wooden whelping box (1.2x1.2 m). Newspapers cut in stripes were used as lining in the whelping box. Central heating/air-conditioning was available within the housing area; extra heating was provided for up to 45 days after whelping (depending on the season) by means of a heating-lamp, which was hanging at approx. 1.00 m above the floor.

The adult female dogs were given commercially prepared, high-energy, dry-feed, twice (during pregnancy) or thrice (during the *puerperium*) daily; water was available *ad libitum*. Extra feeding was provided for the puppies, according to their number, starting at the age of 30 days. Pens were cleaned daily with minimum interference to the animals.

Standard clinical and paraclinical examinations were carried out in the animals, starting before their first oestrus, in order to confirm that animals were healthy for the forthcoming study. Ultrasonography was used to confirm pregnancy and helped to predict a possible date of whelping. Results of examinations performed outside the *puerperium*, do not form part of this thesis. Specifically for the measurement of haematological and blood biochemical parameters, samples were collected on the following days before whelping: 58-55 (D-50s), 49-43 (D-40s), 36-30 (D-30s), 25-20 (D-20s), 15-11 (D-10s), 9-7 (D-00s-1) and 3-1 (D-00s-2) days; these results are included in the thesis.

All animals whelped normally, with no obstetrical assistance.

Subsequently, all animals were monitored from whelping until the 84th day *post-partum*. Examinations were carried out on the day of whelping (D0), as well as 1 (D1), 2 (D2), 4 (D4), 7 (D7), 10 (D10), 14 (D14), 21 (D21) days after whelping and at weekly intervals thereafter up to 84 (D84) days after whelping. The following examinations were carried out.

- General clinical examination (female dogs and puppies).
- Clinical examination of the genital system.
- Ultrasonographic examination of the uterus and the ovaries.
- Clinical examination of the mammary glands.
- Ultrasonographic examination of the mammary glands.
- Measurement of haematological and blood biochemical parameters.
- Measurement of blood serum progesterone concentration.
- Bacteriological and cytological examination of vaginal swab samples.
- Bacteriological examination and cytological examination of teat duct material and milk samples.
- Behavioural observations; behaviour of each bitch and her litter was first recorded on the day subsequent to whelping (D1); thereafter, recordings were carried out every two days until D21, every three days from D24 to D42 and every four days from D46 to D82.

One female dog was subjected to ovario-hysterectomy and partial mastectomy on each of D4, D7, D10, D14, D21, D28, D35, D42, D56 and D70; finally, on D84, two dogs were operated. Appropriate tissue samples were collected for detailed examinations and the following were studied:

- Gross appearance of the uterus and the ovaries.
- Bacteriological and cytological examination of uterine content samples.
- Histological, histometric and ultrastructural examination of uterus and ovary tissue samples.
- Bacteriological examination of mammary parenchyma samples.
- Histological, histometric and ultrastructural examination of mammary parenchyma tissue samples.

Subsequently to the operation, animals were excluded from the study and, at the end, were fostered by local people.

General clinical examination of experimental animals

A standard general clinical examination was carried out in the female animals. Rectal temperature was measured, skin appearance was evaluated, mucosae were examined, capillary refill time was calculated and heart and lungs were auscultated. Animals were weighed and, finally, jugular vein blood samples were collected into separate vials with heparin or ethylenediaminetetraacetic acid, as well as in plain vials. Subsequently, the newborn puppies were also clinically examined and were weighed.

Clinical and ultrasonographic examination of the genital system - collection of vaginal samples

The genital system was examined clinically and ultrasonographically with the bitch in the standing position on an examination table and restrained by an assistant. The external genitalia were observed. Presence of vaginal discharge was evaluated; if there was any, its quantity, appearance, consistence and viscosity were described. The uterus was palpated through the abdominal wall, to evaluate its consistency and to estimate the diameter of the body of the uterus. The following dimensions of the vulva were measured, by using a cutimetre (Hauptner Instrumente, Dietlikon-Zurich, Switzerland): (i) total horizontal width × total vertical length and (ii) distance from anus to upper vulval commissure. Total horizontal width was measured from the outer edge of the left labia to the outer edge of the right labia, whilst total vertical length was measured from the upper to the lower vulval commissure (Fig. II.1).

For ultrasonographic examination, hair in the abdomen was fully clipped and coupling gel was applied thereon. A convex transducer with 2.6-6.0 MHz imaging frequency (AMI B7; Alliance Medical, Quebec, Canada) and a linear transducer with 7.5-12 MHz imaging frequency (MyLab[®] 30; ESAOTE SpA, Genova, Italy) were used. The transducer was placed on the ventral caudal abdominal wall, in order to initially image the urinary bladder, which, used as an acoustic window, facilitated examination. The uterus was found positioned ventrally to the rectum and laterally or dorsally to the bladder. Then, the probe was moved cranially and along the midline of the body, in order to image the cervix and/or the body of the uterus, which was followed cranially. The horn bifurcation was observed to confirm that the uterus was being continually imaged. Then, the probe was moved to the right and to the left, in order to image the uterine horns, ending caudally to the respective kidney (Fig II.2). At that point, the spleen was also imaged and used as another acoustic window to the examination of the left uterine horn. Images were obtained on the longitudinal and

the transverse ultrasonographic planes. A 30 to 80 mm scanning depth was used. During the examination, the echogenicity of the uterus, the presence of layers in the uterine wall, the potential presence of fluid or other content in the uterine lumen and the width of the uterine horns (in at least one placental site and one interplacental area) were assessed; thickness of layers of the uterine wall was measured. Finally, the ovaries were imaged; each kidney was used as a guide to image the respective ovary; transverse and longitudinal planes of the ovaries were taken. A 30 to 60 mm scanning depth was used.

The external genitalia were cleansed with povidone iodine scrub solution (Betadine®; Mundipharma Medical Company, Basel, Switzerland). Two sterile swabs (one after the other) were introduced, through a sterilised Hannover-type vaginoscope, deeply into the vagina, in order to sample any discharge present at the outer entrance of the cervix and the anterior part of the vagina (for bacteriological and cytological examination). The vaginoscope was removed; a saline-moistened swab was inserted, through a speculum, into the caudal part of the vagina. Then, the vaginal wall was gently swabbed and the swab was withdrawn (for cytological examination)

Figure II.1. Picture of the perigenital and the perianal region of a clinically healthy Beagle-breed female dogs, during the *puerperium*, to show how measurements in the area were carried out.

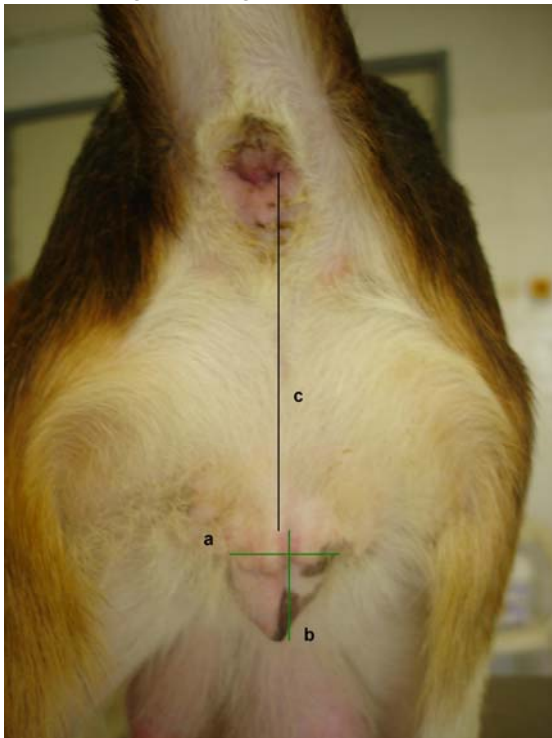

a: total horizontal width, b: total vertical length, c: distance from anus to upper vulval commissure.

Figure II.2. Diagrammatic presentation of ultrasonographic examination of the genital system of clinically healthy Beagle-breed female dogs, during the *puerperium* (modified from Hetch 2008).

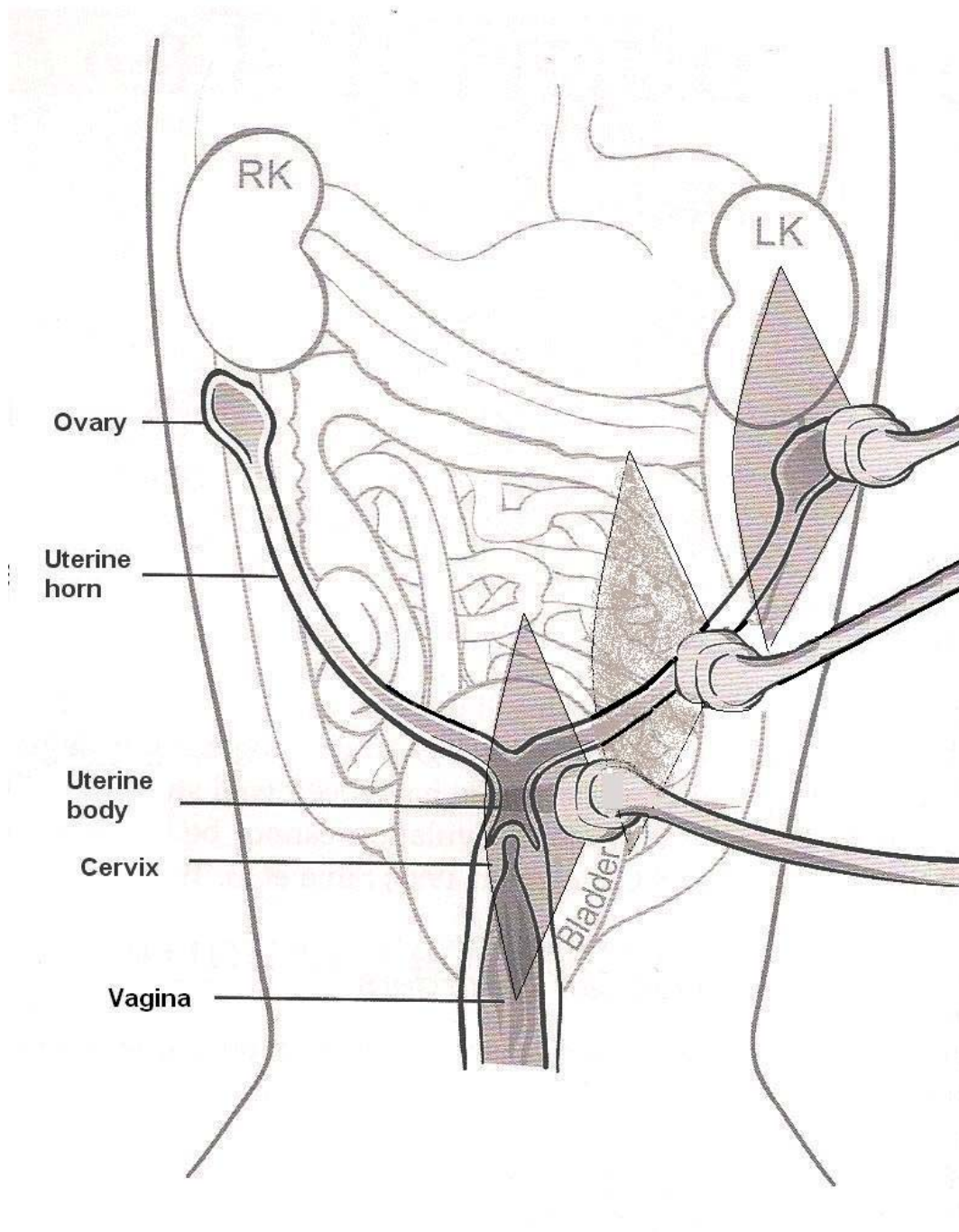

RK: right kidney, LK: left kidney.

The three drawings of the transducer indicate the course followed during examination.

Clinical and ultrasonographic examination of the mammary glands - collection of teat duct material and milk samples

The mammary glands were examined clinically and ultrasonographically with the bitch in the standing position on an examination table and restrained by an assistant. The mammary glands were observed, palpated and compared to each other; their shape, size and consistency were assessed and recorded.

Ultrasonographic examination of the mammary glands was also carried with the bitch in the standing position and restrained by an assistant. A linear transducer with 7.5-12 MHz imaging frequency (MyLab[®] 30; ESAOTE SpA, Genova, Italy) was used. The transducer was placed on the ventral abdominal wall of the right caudal mammary gland to initially image that gland; then it was moved cranially, in order to image the right-side mammary glands. The procedure was repeated for the left side (Fig. II.3). During the procedure, the liver and the spleen of the animal were used as reference standards for defining the echogenicity of the mammary glands during imaging. Images were obtained on the longitudinal ultrasonographic plane. A 40 to 60 mm scanning depth was used.

Teat duct material and milk samples were then collected. Milk samples were collected from the following five mammary glands: Rc1, Rc2, Rc3, Rc4 (Rc1: the caudal gland in the right side, Rc2 the gland cranially to Rc1, etc.) and Lc2 (contralateral to Rc2). Teat duct material samples were collected from a teat duct of the Rc2 gland (Rd2 duct) and a teat duct of the Lc2 gland (Ld2 duct); in each bitch, the teat ducts for sampling had been defined immediately *post-partum*, their topographical location was recorded so that samples were collected from the same ducts throughout the study.

At the beginning, 2 to 3 min prior to sample collection, the bitch was intramuscularly injected with 3 iu of oxytocin (Oxytocin; Ceva Santé Animale, Llbourne, France). Hair covering the mammary glands and the teats had been clipped. The teat and the abdominal skin adjacent to the teat were disinfected twice, by using cotton moistened with sterile water and povidone iodine scrub solution (Betadine[®]; Mundipharma Medical Company, Basel, Switzerland). Subsequently, a sterile cotton gauze also moistened with sterile water and povidone iodine scrub, was used for a final disinfection; then, the area was swabbed with a sterile gauze to dry. After that, the procedure was carried out rather quickly, in order to avoid any accidental contamination (e.g., by the tail or the thigh skin) of the disinfected area.

Initially, a sterile, plastic, 26 G catheter (Abbocath[®]; Abbott Laboratories, Abbott Park, IL, USA) was used for sampling the mucosa of a teat duct. The catheter stylet was taken out and the

plastic catheter was cut with a sterile blade to a length of 2 mm (Fig. II.4). In order to ensure accurate and consistent cutting of the catheter at the desired length, a sterilized ruler was always placed beside the catheter; the whole procedure was carried out under aseptic conditions on sterilized surgical screens. Detailed description of the method was presented by Mavrogianni and others (2006). The catheter was held by the investigator from the cannula hub; it was inserted into the teat, rolled around the internal teat wall in order to sample the mucosa, for bacteriological examination, and then withdrawn.

For collection of milk, the base of the teat was squeezed between the thumb and the index finger of the gloved hand of the investigator. A few (2 to 4) drops of secretion were expressed on the gloved hand of the investigator and examined for presence of abnormalities. Subsequently, further 2 to 3 drops of secretion were expressed directly onto a sterilised bacteriological loop. Finally, a quantity of 1.0 mL of secretion was collected into a plastic miniature tube for testing by the Whiteside test. The appearance of the secretion was recorded.

Figure II.3. Diagrammatic presentation of ultrasonographic examination of the mammary glands of clinically healthy Beagle-breed female dogs, during the *puerperium* (modified from Nautrup 2001).

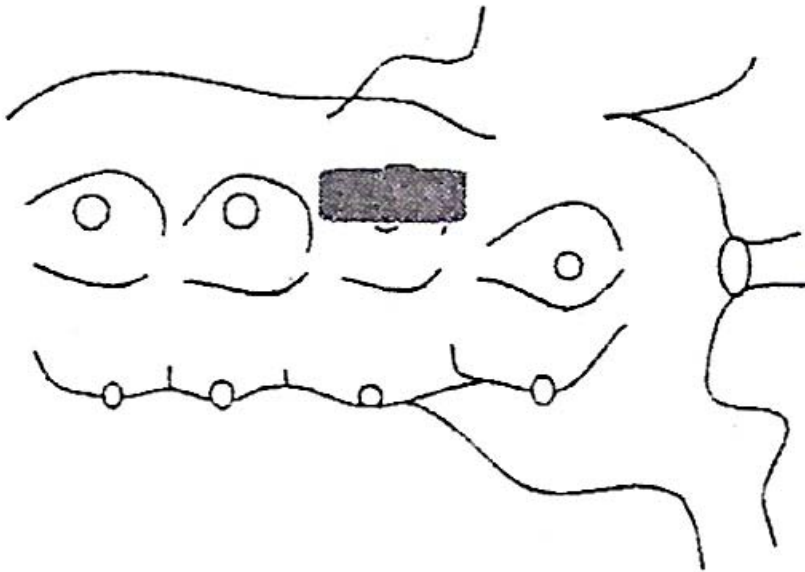
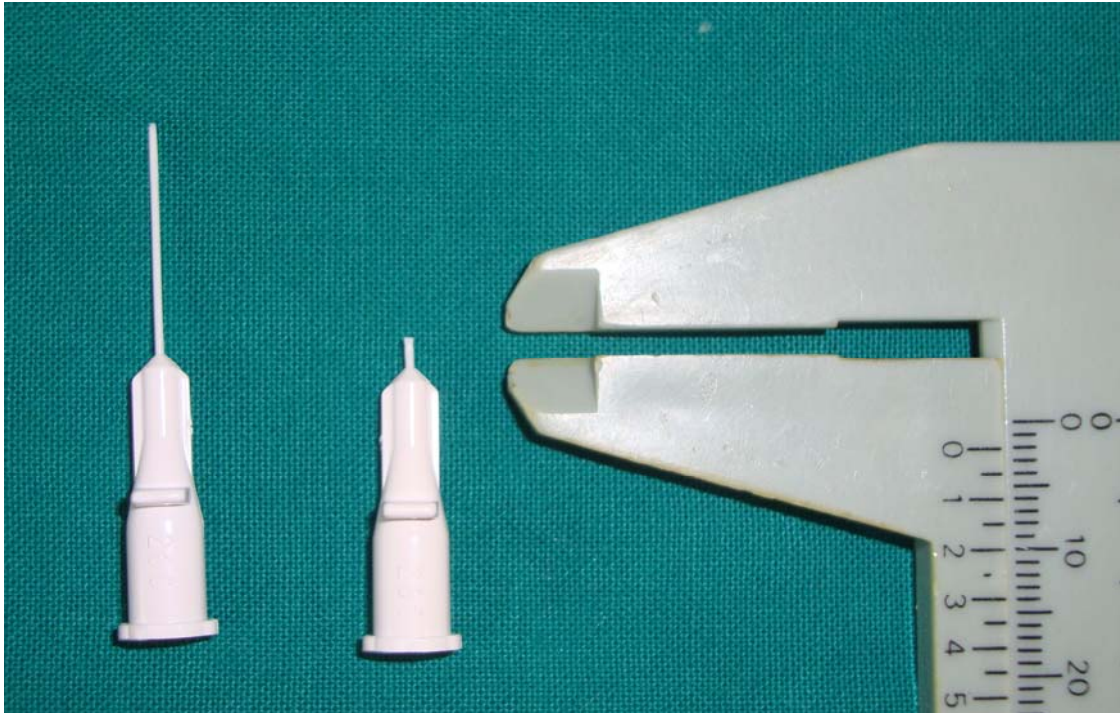

Fig. II.4. Left: plastic 26 G catheter (Abbocath®); right: plastic 26 G catheter (Abbocath®) cut to a length of 2 mm, which was used for sampling material from the teat duct.



Measurement of haematological and blood biochemical parameters

Measurement of haematological and blood biochemical parameters started within 60 min after collection.

Standard haematological tests (haematocrit, leucocyte count, thrombocyte count, mean corpuscular haemoglobin concentration, haemoglobin concentration, fibrinogen concentration) were carried out by using a blood-analyser (QBC Vet Autoreader®; IDEXX Laboratories Inc., Westbrook, MN, USA); in the case of fibrinogen concentration, Millar's technique was applied. Leucocyte subpopulations were identified by direct microscopy after Giemsa stain of blood films; in each case 400 cells were observed and counted.

Measurements of total serum protein and albumin concentrations, as well as of alkaline phosphatase activity and glucose concentrations were carried out in a biochemical analyzer (Vet Test 8008®; IDEXX Laboratories Inc., Westbrook, MN, USA); globulin concentration was measured by deducting albumin concentration from total serum protein concentration. C-reactive protein concentrations were measured by using a canine-specific immunoassay (CRP ELISA®; Tridelta, Maynooth, Ireland) and an automated microplate reader (Wellscan®; Denley Instruments,

Colchester, United Kingdom). Ionised calcium concentrations were measured by using a biochemical analyser (Vet Stat Electrolyte and Blood Gas Analyser[®]; IDEXX Laboratories Inc., Westbrook, MN, USA). Finally, ionised magnesium and total calcium concentrations were determined by using a flame atomic absorption spectrophotometer (Perkin Elmer A Analyst 100; Perkin-Elmer, Waltham, MA, USA).

Measurement of blood serum progesterone concentration

Blood serum progesterone concentration was measured by a no-extraction solid phase ¹²⁵I radioimmunoassay method (Coat-a-Count[®]; Siemens Medical Solutions, Los Angeles, CA, USA) in 100 µL samples in duplicate according to the manufacturer. The sensitivity of the assay was 20 pg mL⁻¹. Coefficients of variation were as follows: intra-assay 8.8% and 3.9% and inter-assay 9.7% and 5.6% for the sample of low (0.31 ng mL⁻¹) and high (18.00 ng mL⁻¹) progesterone concentration, respectively.

Bacteriological and cytological examination of vaginal samples

Samples collected from the vagina were processed soon (~10 min) after collection.

One swab of those collected from the anterior part of the vagina was cultured on 5% sheep blood agar plates. Media were incubated aerobically and anaerobically at 37 °C for up to 48 hours; if no bacterial growth was evident, they were reincubated for another 24 hours. Bacterial identification was carried out by using a complete series of biochemical tests (Barrow and Feltham 1993, Euzeby 1997) and the API SYSTEM[®] quick identification strips (BioMerieux, Marcy l' Etoile, France).

Smears were made from the second swab from the anterior part of the vagina on a glass slide and stained with the Giemsa technique. Smears were evaluated to observe epithelial cells and leucocytes, to assess leucocyte subpopulations, as well as to record presence of other types of cells. Moreover, smears were evaluated by means of semi-quantitative observational method using the 40× objective lens of a Zeiss-Axiostar Microscope (Carl Zeiss, Göttingen, Germany) with a 10× eyepiece lens, to take account of number of cells observed; results were reported on the following scale: '0' (no cells observed in the slide), '1' (on average, ≤3 cells per optical field), '2' (on average, 4-7 cells per optical field), '3' (on average, 8-15 cells per optical field) and '4' (on average,

≥16 cells per optical field). In each slide, at least 100 fields were observed and the findings averaged to calculate the above score. Separate countings were performed and separate cell counting scores were produced for epithelial cells and for leucocytes.

Smears were made from the swab from the caudal part of the vagina on a glass slide and stained with the Giemsa technique. Smears were evaluated to observe vaginal epithelial cells and to assess proportion of epithelial cells' subpopulations, as well as presence of other, non-epithelial vaginal, cells.

Bacteriological and cytological examination of teat duct material and milk samples

Teat duct material and milk samples collected were processed soon (~10 min) after collection.

Samples were cultured on 5% sheep blood agar plates. Media were incubated as above; bacterial identification was also carried out as above.

The Whiteside Test (WST) was carried out in each milk sample. Five drops of milk (~0.1 mL) were deposited on a clean slide and, then, two drops of 1 N NaOH solution were added. The mixture was swirled by using a bacteriological wire. The resulting clot formation was scored '-', '±', '1+', '2+', '3+' or '4+', by evaluating the degree of reaction (thickness and tenacity of the coagulum), as detailed in Table II.i (Schalm et al. 1971, Ververidis, Mavrogianni et al. 2007).

Milk films were made by directly smearing 20 µL from each sample on a microscope objective plate and stained with the Giemsa method. Proportion of leucocyte subpopulations was determined by counting at least 100 cells using the 100× objective lens of a Zeiss-Axiostar Microscope (Carl Zeiss, Göttingen, Germany) with a 10× eyepiece lens.

Table II.i. Description of the the degree of reaction observed in the Whiteside Test.

Degree of reaction	Description of reaction
-	Mixture opaque and free of particles
±	No apparent reaction during stirring, without obvious finely dispersed particles, even at close inspection
1+	Thickening during stirring, with little or no tendency for the mass to adhere to the wire; on continued stirring, separation of the mixture into milky whey and white particles
2+	Mixture thickening almost as soon as stirring starts, with the coagulum following the wire and, finally, separating into clear whey and white, thread-like whirls
3+	Immediate formation of a tenacious mass, adhering to the wire, upon continued stirring, separating into whey and thready, clumped, opaque material
4+	A tenacious coagulum with little or no tendency to break down into whey and particulate material

Behavioural observations

Behavioural data were recorded with two digital, colour video cameras (model 92E, Sony, Japan), with lens' focal length: 3.7 to 37 mm and observation angle 40 to 62 °, using a continuous focal observation method on individual bitches and their puppies. Cameras were placed on the centre of the narrow side of the pen (on the outside), on a tripod 2.0 m above the floor, to allow observation of the whole whelping box and pen (Fig. II.5).

Observation period was from 09.00 to 21.00, with the exception of a 2 hour interval in the afternoon; the first 60 min of that interval, the animals were fed, groomed and sampled (if sampling was scheduled). Animals were also fed early in the morning and in the night, before and after the daily observation period, respectively. During the observation period, no human movements within the penning area were allowed. On each observation day, within the above daily observation period, behaviour of each bitch and her litter was recorded for three 50 min slots. Observations were carried out in a random manner to ensure that data collection for each bitch and her litter were equally spaced within the daily observation period throughout the study. Definitions of bitch and puppy behaviours recorded during the study ('ethogram') are in Table II.ii.

Figure II.5. Diagrams of penning arrangements of clinically healthy Beagle-breed female dogs, during the *puerperium*. Animals were penned in individual pens (1.5×3.0 m); equidistant to three sides of the pen, there was a wooden whelping box (1.2×1.2 m).
 (a) View from above.

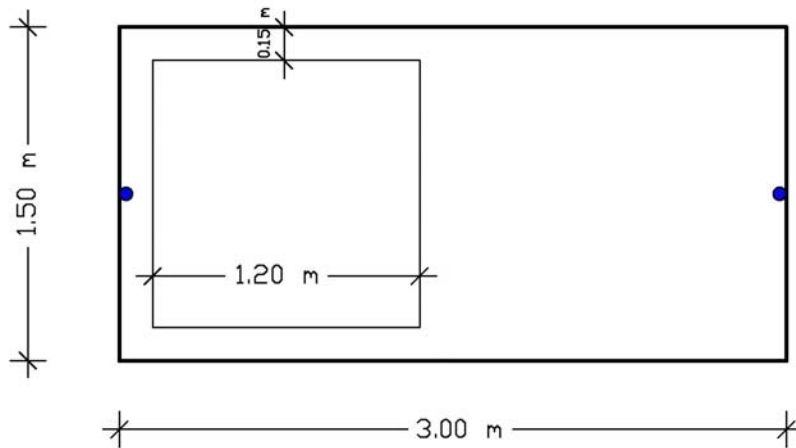

(b) Lateral view.

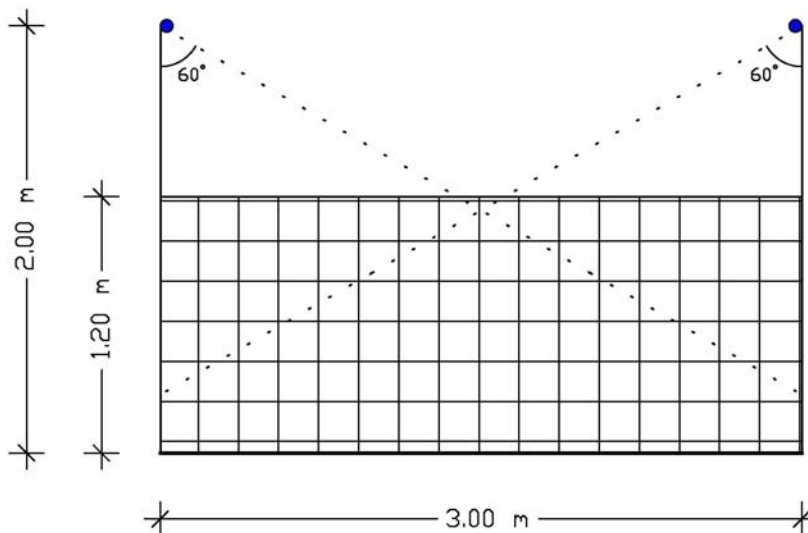

(c) Lateral view, sectioned.

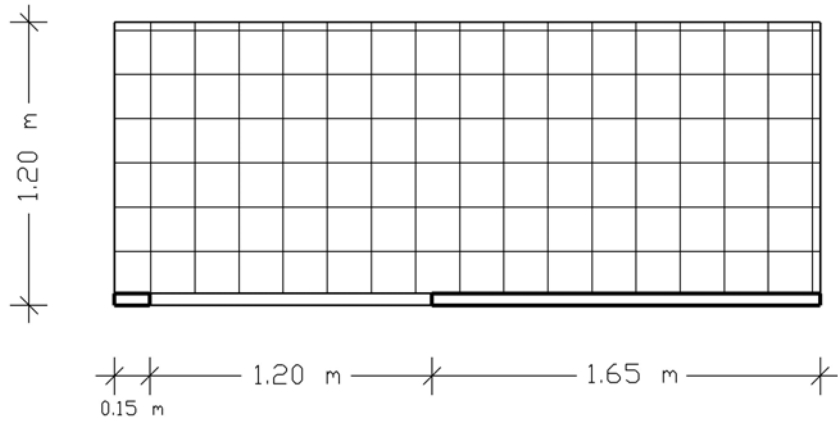

(d) Frontal view.

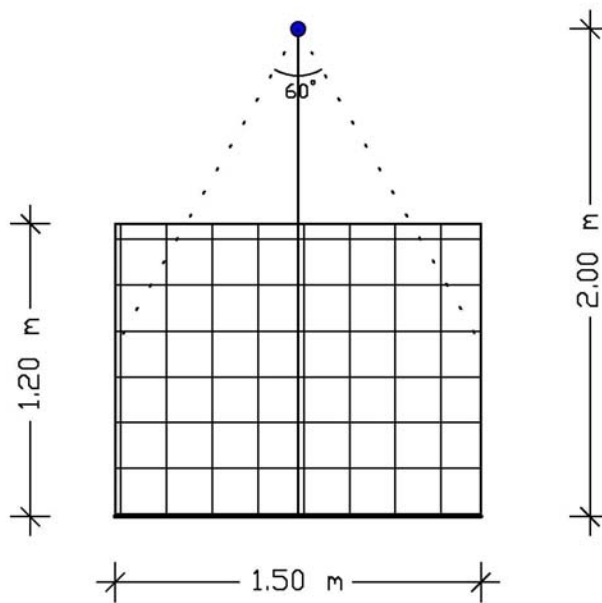

(e) Frontal view, sectioned.

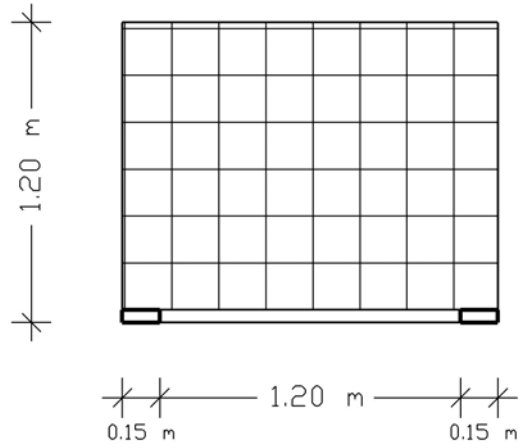

Legend. Blue dots: cameras, interrupted lines: camera observation angle.

Table II.ii. Definitions of bitch and puppy behaviours recorded during focal observation.

Definitions of bitch behaviours	
Butting (B)	Pushes puppy(ies) down or away with downwards, sideways or forwards movements of head
Lying away from puppies (LA)	Sleeps or lies down inactive inside the whelping box or observing outside the whelping box, with no contact with puppies
Lying in contact with puppies (LC)	Sleeps or lies down inactive inside the whelping box or observing outside the whelping box, but in contact with at least one puppy
Grooming herself (GH)	Licks herself, usually in the perigenital area
Grooming puppy (GP)	Touches puppy with nose or makes licking and nibbling movements directed towards a puppy
Inside whelping box (IWB)	At least one leg is inside the whelping box
Outside whelping box (OWB)	All four legs are outside the whelping box
Playing (PL)	Plays with puppy(ies)
Protecting puppies (PP)	Covers puppy(ies) with paper within the whelping box
Vocalizations (VL)	Barks
Definitions of puppy behaviours	
Inside whelping box (IWB)	At least one leg is inside the whelping box
Investigates dam (ID)	Makes contact with its head to any part of the dam's body, except the inguinal or abdominal area
Lie down (LD)	Sleeps or lies down inactive or observing outside the pen
Outside whelping box (OWB)	All four legs are outside the whelping box
Playing (PL)	Plays with dam or other puppy(ies)
Searching teat (ST)	Investigates inguinal or abdominal area of bitch and sniffs/licks to suck, but has not teat into mouth
Sucking attempt (SA)	Has teat into mouth for <11 sec
Successful suck (SS)	Has teat into mouth and appears to suck, for >10 sec
Sucking bout (SB)	One SS which is >10 sec after the previous one and/or before the next one OR a sequence of at least two SS <11 sec apart.

Procedures for ovario-hysterectomy and mastectomy

Pre-operatively, no feed was provided to the animal for 12 hours prior to the surgery; water was withdrawn 4 hours prior to surgery. The bitch was then sedated by intramuscular administration of acetylo-promazine (0.05 mg kg⁻¹ bw; Acepromazinum[®]; Streuli Pharma, Uznach, Switzerland); intravenous administration of thiopental sodium (5.0-8.0 mg kg⁻¹ bw; Pentothal[®]; Abbott Laboratories Inc., Abbott Park, IL, USA) was used to induce general anaesthesia, which was maintained by 2% halothane (Halothane R-M[®]; Merial Italia, Assago, Italy). The bitch was placed in dorsal recumbency on a surgical table and prepared for midline abdominal surgery. Standard pre-operational procedures (fine hair clipping, skin disinfection etc.) were performed to prevent accidental contamination of the surgical field.

Initially, ovario-hysterectomy was carried out, by following the procedure previously described (chapter I, section C) ,and the genital tract was removed under sterile conditions. Subsequently, four mammary glands (Rc1, Rc2, Rc3, Lc2) were excised by using a standard mastectomy procedure (Hedlund 2007); the mammary glands, the respective teats, the overlying skin and the right inguinal lymph node were removed *en bloc* and under aseptic conditions for examination. In all cases and in order to avoid inadvertent tissue damage, only mosquito-type forceps (rather than electro-cauterization) were used before ligation of vessels.

Appropriate subcutaneous and skin sutures were performed. An injectable antibiotic (amoxicillin plus clavulanic acid; Sunylox[®], 0.05 mL kg bw⁻¹, sc; Pfizer, NewYork, NY, USA) and a non-steroid anti-inflammatory agent (carprofen, 2 mg kg bw⁻¹, iv; Rimadyl[®]; Pfizer, NewYork, NY, USA) were administered post-operatively. Following recovery, the bitch was held in a post-operative pen for 4 hours after operation, after which she was allowed to join her litter. All animals recovered uneventfully.

Examination of the uterus and the ovaries - collection of samples

After removal from the animal, the genital tract was transferred to an adjacent table, under aseptic conditions, for collection of samples and examination. Initially, the appearance of the uterus was recorded. Then, a small incision was performed on the lateral part of each uterine horn and, by using an aseptic technique, one sterile fine swab was inserted into each horn to sample its content for bacteriologica and cytological examination.

The length (from the apex of the horn to the bifurcation of the uterus) and the width (at placental sites and at interplacental areas) of each uterine horn were measured. Average of the length of the two horns was calculated; average of width measurements at placental sites and of width measurements at interplacental areas were calculated separately. The uterus was then dissected longitudinally; the placental sites and the interplacental areas were assessed and their dimensions (length, height) were measured; length of each placental site and each interplacental area was measured parallelly to the axis of the uterine horn; height of each placental site and each interplacental area (measured by a cutimetre [Hauptner Instrumente, Dietlikon-Zurich, Switzerland] included the underlying uterine wall. Average of the length and height of placental sites and of interplacental areas were calculated separately.

Uterine tissue samples were excised as follows: one sample from each uterine horn, which included part of a placental site and an interplacental area. Tissue samples were placed into

formalin solution and into sodium cacodylate (0.1 M) buffered solution of 2% glutaraldehyde and 2% paraformaldehyde.

Finally, dimensions (length×width×height) of each ovary were measured. One longitudinal section was performed on each ovary and the number and diameter of *corpora albicantia* (as previously defined [chapter I, section A]), that could thus be observed, were measured.

Examination of the mammary glands - collection of samples

After removal from the animals, the mammary glands were transferred to an adjacent table, under aseptic conditions, for collection of samples and examination. The abdominal skin was removed. The number of orifices in the teat of each mammary gland removed, was measured. The appearance of the mammary glands was recorded.

Initially, by using an aseptic technique, a small incision was made and a sterile fine swab was inserted into the Rc1 gland, through its dorsal surface, to sample the parenchyma. The procedure was repeated, with different swabs each time, for all mammary glands removed. Subsequently, the length (in-between the caudal and cranial borders of the gland) and the width (at the middle of the gland, crossing at the teat) of the excised mammary glands were measured by using a cutimetre (Hauptner Instrumente, Dietlikon-Zurich, Switzerland).

Mammary parenchyma tissue samples (two samples from each mammary gland removed) were excised and placed into formalin solution and into sodium cacodylate (0.1 M) buffered solution of 2% glutaraldehyde and 2% paraformaldehyde.

Bacteriological and cytological examination of uterine content samples

Samples collected from the uterus were processed soon (~10 min) after collection.

Initially, both swabs (one from each horn) were cultured on 5% sheep blood agar plates. Media were incubated as above; bacterial identification was also carried out as above.

Then, smears were made from each swab on a glass slide and stained with the Giemsa technique. Smears were evaluated to observe epithelial cells and leucocytes, to assess leucocyte subpopulations, as well as to record presence of other types of cells. Moreover, smears were evaluated by means of the semi-quantitative observational method described above, on the '0' to '4' scale, to take account of number of cells observed;

Bacteriological examination of mammary parenchyma samples

Samples collected from the mammary parenchyma were processed soon (~10 min) after collection. The swab from each mammary gland was cultured on 5% sheep blood agar plates. Media were incubated as above; bacterial identification was also carried out as above.

Histological, histometric and ultrastructural examination of uterus, ovary and mammary parenchyma tissue samples

Tissue samples were processed with standard haematoxylin and eosin (H&E) staining procedures. Slides were numbered to prevent observer bias and the sections were observed in a Zeiss-Axiostar Microscope (Carl Zeiss, Göttingen, Germany) with 5x, 10x, 40x or 100x objective lenses and a 10x eyepiece lens and in a Zeiss-Axioplan 2 Microscope (Carl Zeiss, Göttingen, Germany) with 40x, 100x or 250x objective lenses and a 1x eyepiece lens.

Initially, the histological features in the tissue samples were described. Subsequently, histometric examination was performed; all histometric examinations were performed by using the Image Pro-Plus[®] image processing and analysis software, v. 6.0 (Media Cybernetics, Bethesda, MD, USA).

Thickness of the myometrium was measured in 8 to 11 sites, selected at random in each uterus tissue sample. The internal diameter of 6 to 8 uterine glands (including the height of epithelial cells) selected at random within each horn of the uterus of each female dog (i.e., 12-16 uterine glands in total) was measured; the height of three epithelial cells in each of these glands (i.e., in 36-48 epithelial cells per animal) was also measured. Results from samples from the two horns were computed and averaged together. The number of alveoli within three separate lobules selected at random in each of the four mammary glands removed from each female dog (i.e., in 12 lobules per animal), was counted. The number of mammary epithelial cells within three alveoli in each of the above 12 lobules (i.e., in 36 alveoli per animal), was also counted. The internal diameter of 12 alveoli (including the height of mammary epithelial cells) per animal (i.e., 3 alveoli per mammary gland) was measured; also, the height of three epithelial cells in each of these

alveoli (i.e., in 36 epithelial cells per animal) was also measured. Results from the two samples excised from each mammary gland were computed and averaged together.

Tissue samples were also prepared for ultrastructural examination by using scanning electron microscope. Specimens placed into the sodium cacodylate (0.1 M) buffered solution of 2% glutaraldehyde and 2% paraformaldehyde, were washed in several changes of sodium cacodylate buffer, transferred for 1 hour to 1% OsO₄ and dehydrated in graded acetone. Tissues were critically point-dried in carbon dioxide, mounted onto stubs and sputter-coated with palladium and gold in a Bal-Tec sputter coater. They were observed in a JEOL-JSM 840 scanning electron microscope (JEOL, Tokyo, Japan).

Data management

Stages of the *puerperium*

For the purposes of analysis of results of the study, the *puerperium* was divided into four stages: L1 included samples collected from D0 (i.e., day of whelping) to D7 (7 days after whelping) (n=59), L2 included samples collected from D8 to D21 (n=27), L3 included samples collected from D22 to D42 (n=18) and L4 included samples collected from D43 to D84 (n=18).

Specifically for analysis of haematological and blood biochemical parameters, samples collected during pregnancy were also taken into account. For the purposes of analysis of these results, pregnancy was divided into three stages: P1 included samples collected during the first week after mating (D-50s) (n=12), P2 included samples collected during the subsequent 45 days (D-40s, D-30s, D-20s, D-10s) (n=24) and P3 included samples collected during the last week before whelping (D-00s-1 and D-00s-2) (n=17). Jointly, P3 and L1 formed the 'peri-parturient-period', extending from last week of pregnancy to beginning of second week of the *puerperium*.

Modelling for analysis of infection results

There is a difficulty with attempts to estimating incidence rate (new 'infection' per animal at risk for each time point at risk). In many cases, an individual site (anterior vagina or teat duct or mammary gland) might change from being 'infected' to being 'uninfected' and *vice-versa*; therefore, when there was a long time-interval between sampling points, it was not possible to know what

happened between the two sampling points (i.e., how many infections and 'cures' there might have occurred). Therefore, the following definitions were initially made.

- 'Isolation of bacteria' was equivalent to 'infection with'; 'isolation of bacteria from the swab' was equivalent to 'infection of the anterior part of the vagina' or to 'infection of the uterus' (in case of swabs from uterine content), 'isolation of bacteria from the catheter' was equivalent to 'infection of the teat duct', 'isolation of bacteria from milk' was equivalent to 'infection of the mammary gland' and 'isolation of bacteria from mammary tissue sample' was equivalent to 'infection of mammary parenchyma'.
- On a particular sampling point, a sampling site (anterior part of the vagina, teat duct, mammary gland) was defined as being 'at risk of becoming infected' (i.e., becoming bacteriologically positive) if it had been uninfected (i.e., bacteriologically negative) on the previous sampling point. On the subsequent sampling point, this sampling site (anterior part of the vagina, teat duct, mammary gland) could be either 'infected' (in which case it was not at risk) or 'uninfected' (in which case it was still at risk). On subsequent sampling points, if this site was 'uninfected', then it was again 'at risk'.
- If a sampling site (anterior part of the vagina, teat duct, mammary gland) was infected on one sampling point but not on the next one, then the infection was deemed to have been eliminated half-way between the two sampling points; conversely, if a sampling site was uninfected on one sampling point and infected on the next one, then the infection was deemed to have taken place half way between the two dates.
- If a sampling site (anterior part of the vagina, teat duct, mammary gland) was infected with the same organism on two consecutive samplings, then it was considered to have been infected throughout the period between those two sampling points; conversely, if a sampling site (anterior vagina, teat duct, mammary gland) was uninfected on two consecutive samplings, then it was uninfected throughout the time between those two sampling points.
- Persistence of infection was defined as isolation of the same organism from a sampling site (anterior part of the vagina, teat duct, mammary gland) in at least two consecutive samplings, with a between-sampling interval of ≥ 3 days.

Based on the above, it was possible to calculate an estimate of the length of time a tissue (anterior part of the vagina, teat duct, mammary gland) was at risk before it became infected; sampling sites contributed more than one value, if they became uninfected and then were re-infected.

Analysis of haematological and blood biochemical parameters

Data were entered into Excel (Microsoft Corp., Redmond, WA, USA) and statistical analysis was performed with STATA11 (StataCorp LP, College Station, TX, USA) and MINITAB16 (Minitab Inc., State College, PA, USA). After performing basic descriptive statistics, variables were transformed, if this improved the assumptions of normality and homoscedasticity. Log transformations were used for most variables; 10 were not transformed, the square root was used twice and the inverse square root and cube were used once each. Where data were transformed for analysis, results were back-transformed in order to present their values in the original units. The relationship of parameter values with stage was investigated by fitting a mixed effect linear regression in STATA11, using the `xtmixed` command with maximum likelihood estimation and declaring the animal's identity and the day to be crossed random effects. Where there was a significant overall effect of stage, as judged by the change in deviance, the effect of given stages was compared with the mean of all other stages combined using a Bonferroni correction; the same method was used for the means of the stages P3 and L1.

A proposal for a 'reference' range for the peri-parturient period was obtained by fitting the same mixed effect linear regression as above, but using only the observations from the peri-parturient period, only fitting a constant term and using restricted maximum likelihood estimation. From this, an estimate of the mean and of the estimated residual standard deviation was obtained. For the proposal, a range was calculated by taking the estimated mean (the constant term from the model) ± 2 standard deviations.

Analysis of bacteriological findings in teat duct material - Analysis of bacteriological and cytological findings in milk

Data were entered into Excel (Microsoft Corp., Redmond, WA, USA) and statistical analysis was performed with STATA9 (StataCorp LP, College Station, TX, USA) and MINITAB14 (Minitab Inc., State College, PA, USA) using survival analysis. Initially the Kaplan-Meier method and a log rank test were applied. The Cox Proportional Hazards method was then used, if the above applications suggested a possible significant difference ($P \leq 0.09$); if no evidence of a possible significant difference was suggested ($P > 0.09$), then the analysis was not pursued further.

For calculation purposes, numerical values were given to WST scores as follows: score '-' = 0, score '±' = 1, score '1+' = 2, score '2+' = 3, score '3+' = 4, score '4+' = 5. The Kruskal-Wallis test was employed to estimate differences in WST scores between (a) the four stages of the *puerperium* and (b) the mammary glands studied. Differences between individual *puerperium*

stages were tested by the Mann-Whitney test; Bonferroni-like corrections were applied. Finally, the Wilcoxon signed rank test was employed to take account of the repeated measurements on individual animals, although statistical power of the test was limited due to the progressively decreasing number of animals throughout the study.

Analysis of behavioural results

Data were entered into Excel (Microsoft Corp., Redmond, WA, USA). Basic descriptive statistics was initially performed. Median frequency (events) of a specific behaviour throughout a *puerperium* stage was calculated by taking into account total number of events of all animals during the daily observation period (150 min) in all observation days (n=4 for L1, n=7 for L2, n=7 for L3, n=10 for L4) within that *puerperium* stage. Median duration (min) of a specific behaviour throughout a *puerperium* stage was calculated by taking into account total duration of that behaviour in all animals during the daily observation period (150 min) in all observation days within that *puerperium* stage.

Analysis of Variance with repeated measures and the factors being bitches with small litters *versus* bitches with large litters, was used. The data were modelled by means of the Mixed Procedure Model applied in MINITAB14 (Minitab Inc., State College, PA, USA). Data were tested for normality; random effect was attributed to day of experimentation; appropriate transformations were performed where necessary.

Analysis of results of histometric examinations

Data were entered into Excel (Microsoft Corp., Redmond, WA, USA). Basic descriptive statistics was initially performed. The Mann-Whitney and the Kruskal-Wallis tests for non-parametric data were employed in MINITAB 14 (Minitab Inc., State College, PA, USA) to test for differences between stages of the *puerperium*. Differences between mammary glands were examined at each time period and two-sided statistical significance was evaluated using the Wilcoxon signed-rank test.

Analysis of other parameters studied

Data were entered into Excel (Microsoft Corp., Redmond, WA, USA). Basic descriptive statistics was initially performed. Analysis of Variance with repeated measures and the factors

being bitches with small litters *versus* bitches with large litters was employed in MINITAB 14 (Minitab Inc., State College, PA, USA) to test for differences between stages of the *puerperium*. In the case of measurements taken after operation, when only one animal was available at each time-point, no distinction was made to animals with large or small litters. If appropriate, Student's t-test was employed for comparisons of means and χ^2 for comparisons of proportions.

Statistical significance

Statistical significance was defined as $P < 0.05$.

CHAPTER III

RESEARCH WORK:

RESULTS

General clinical findings in experimental animals

All bitches whelped without obstetrical assistance; no *post-partum* intervention was required on any occasion. Two animals gave birth to 4 puppies, one animal gave birth to 5 puppies, two animals gave birth to 6 puppies (one puppy in one animal was found dead after completion of whelping process, one puppy in another animal died within 12 h after birth), three animals gave birth to 7 puppies, two animals gave birth to 8 puppies (one puppy died within 24 h after birth) and two animals gave birth to 9 puppies (one puppy died within 24 h after birth). Ultimately, five bitches had 4 to 5 puppies and seven bitches had 7 to 9 puppies in the study.

Bitches were clinically healthy throughout the study. Mucosae were seen to be pale pink to pink and moist. Capillary refill time varied from 1.5 to 2.0 sec. Rectal temperature varied between 38.5 °C to 39.2 °C. Respiratory rate varied from 20 to 42 breaths per minute; heart rate varied from 72 to 132 beats per minute. No clinical signs characteristic of potential systemic disease (e.g., inappetence, cannibalism, nervous signs, coughing, vomiting, diarrhoea etc.) were observed.

Moreover, no abnormal findings were recorded in any puppy, which had survived the neonatal period (i.e. 76 puppies); all these puppies remained in good health throughout the study (mucosae: pink, capillary refill time: 1.0 to 2.0 sec, rectal temperature: 36.1 °C to 39.5 °C, respiratory rate: 15-35 breaths per minute, heart rate: 110 to 220 beats per minute). No puppy had opened eyes on D10; subsequently, all puppies had opened eyes on D14. Teeth were first observed in some puppies on D14 and in the remaining on D21.

Changes in bodyweight of female dogs during the puerperium were not significant ($P=0.529$), although differences in bodyweight between bitches with large or small litters were significant ($P=0.019$). Bodyweight increase of puppies during the study period was also significant ($P<0.001$) and differences in bodyweight between puppies in large or small litters were also significant ($P=0.026$). Table III.i shows the bodyweight of female dogs and their puppies throughout the study.

Table III.i. Median (range) values of bodyweight in clinically healthy Beagle-breed female dogs, during the *puerperium*.

<i>Puerperium</i> stage	Bodyweight (kg) of all bitches	Bodyweight (kg) of all puppies
L1	11.6 (9.1-12.8)	0.34 (0.23-0.63) ^a
L2	11.3 (9.9-12.9)	0.66 (0.43-1.20) ^a
L3	10.7 (9.5-12.8)	1.37 (0.79-2.00) ^a
L4	10.6 (9.4-12.9)	2.43 (1.23-3.05) ^a
	Bodyweight (kg) of bitches with large litters	Bodyweight (kg) of puppies in large litters
L1	11.7 (9.8-12.7)	0.34 (0.23-0.54) ^a
L2	11.4 (10.4-12.3)	0.58 (0.43-0.88) ^a
L3	10.6 (9.5-11.5)	1.00 (0.79-1.54) ^a
L4	10.6 (10.2-12.9)	1.99 (1.23-2.51) ^a
	Bodyweight (kg) of bitches with small litters	Bodyweight (kg) of puppies in small litters
L1	11.6 (9.1-12.8)	0.35 (0.27-0.63) ^a
L2	11.3 (9.9-12.9)	0.83 (0.55-1.20) ^a
L3	10.8 (10.4-12.8)	1.60 (1.28-2.00) ^a
L4	10.5 (9.4-11.6)	2.80 (2.28-3.05) ^a

L1: D0 (day of whelping)-D7 (7th day after whelping), L2: D8-D21, L3: D22-D42, L4: D43-D84.

Large litters: litters with 7-9 puppies, small litters: litters with 4-5 puppies.

a: progressive changes during the study $P < 0.05$.

Haematological and blood biochemical parameters

Haematological parameters

There was strong evidence ($P < 0.001$) that, during the peri-parturient period (last week of pregnancy and first week of the *puerperium*), haematocrit (Fig. III.1) and haemoglobin concentration decreased, whilst leucocyte counts (Fig. III.2) and thrombocyte counts (Fig. III.3) increased. There was no evidence for an effect on mean corpuscular haemoglobin concentration ($P > 0.05$) (Fig. III.4) or fibrinogen concentration ($P > 0.6$). Detailed results are in Table III.ii.

Moreover, there was evidence that, during the peri-parturient period number of mature neutrophils ($P < 0.001$), lymphocytes ($P < 0.001$) and monocytes ($P = 0.04$) increased. There was no evidence for an effect on proportion of mature neutrophils ($P = 0.44$), proportion ($P = 0.75$) and number ($P > 0.79$) of immature neutrophils, as well as proportion of lymphocytes ($P = 0.12$) and monocytes ($P > 0.9$). Detailed results are in Table III.iii.

Figure III.1. Scatterplot of haematocrit (predicted mean and 95% confidence intervals) in clinically healthy Beagle-breed female dogs, during pregnancy and the *puerperium* (0: day of whelping).

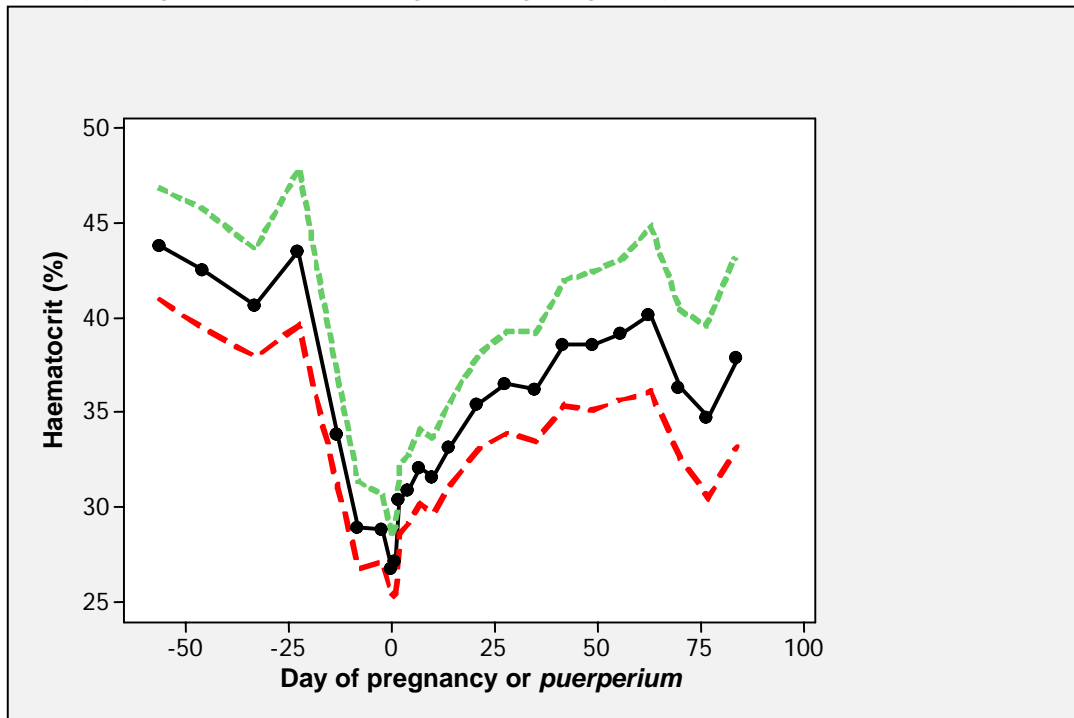

Figure III.2. Scatterplot of leucocyte counts (predicted mean and 95% confidence intervals) in clinically healthy Beagle-breed female dogs, during pregnancy and the *puerperium* (0: day of whelping).

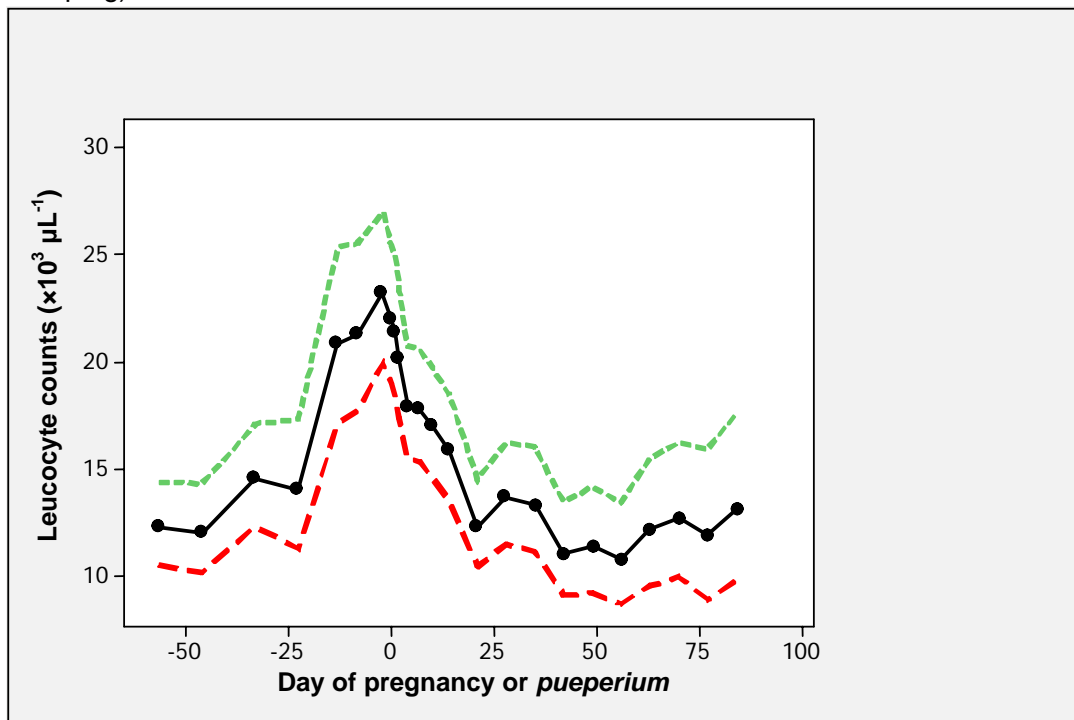

Figure III.3. Scatterplot of thrombocyte counts (predicted mean and 95% confidence intervals) in clinically healthy Beagle-breed female dogs, during pregnancy and the *puerperium* (0: day of whelping).

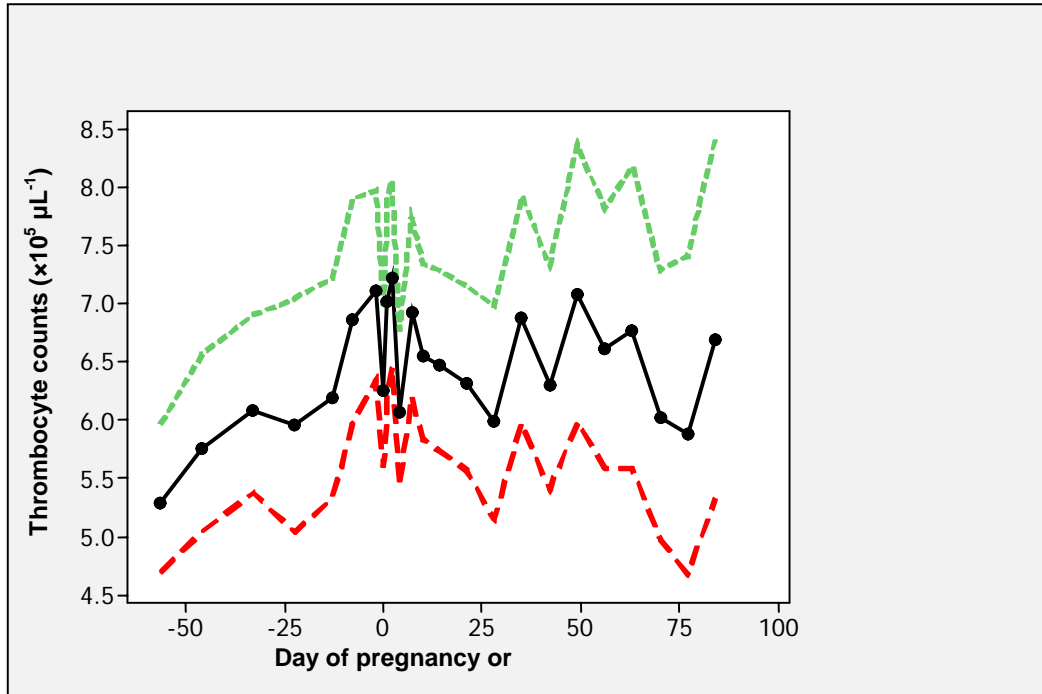

Figure III.4. Scatterplot of mean corpuscular haemoglobin concentration (MCHC) (predicted mean and 95% confidence intervals) in clinically healthy Beagle-breed female dogs, during pregnancy and the *puerperium* (0: day of whelping).

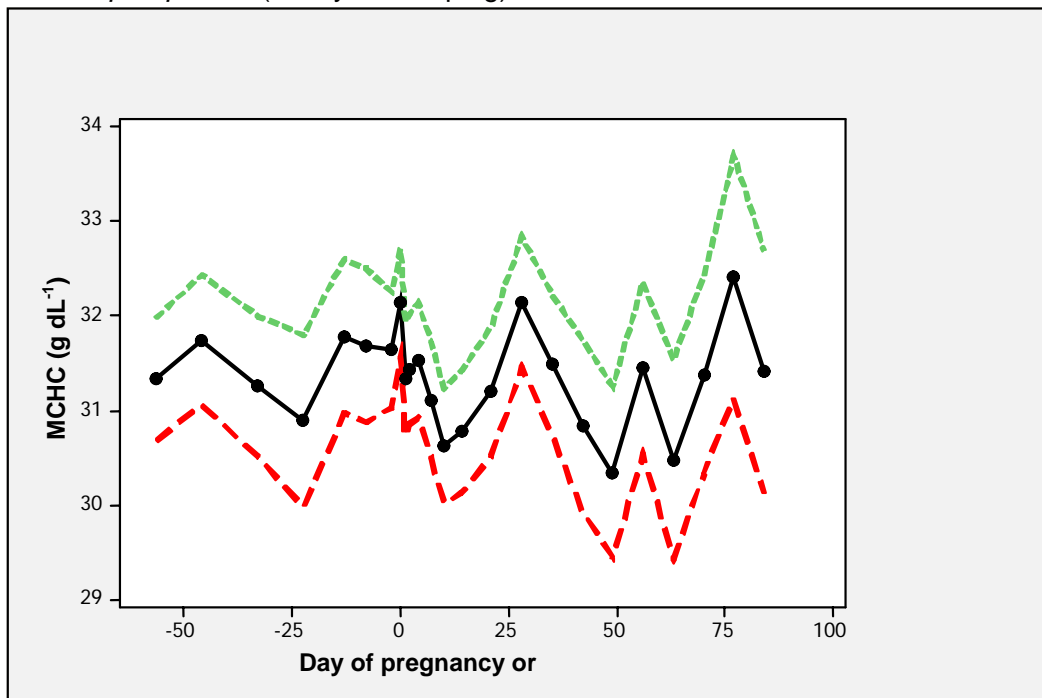

Table III.ii. Median (range) values of haematological parameters in clinically healthy Beagle-breed female dogs, during pregnancy and the *puerperium*.

	Haematocrit (%)	Leucocyte counts (cells μL^{-1})	Thrombocyte counts (particles μL^{-1})	MCHC (g dL^{-1})	Haemoglobin concentration (g dL^{-1})	Fibrinogen concentration (mg dL^{-1})
Pregnancy stage						
P1	43.4 (39.6-51.0)	12,400 (10,400-14,500)	488,000 (446,000-683,000)	32.25 (28.2-32.5)	13.8 (13.0-16.5)	116.0 (96.0-569.0)
P2	39.5 (29.2-52.2)	14,050 (9,500-28,200)	614,500 (441,000-909,000)	31.5 (29.7-33.0)	12.55 (9.6-16.9)	106.0 (37.0-585.0)
P3	29.0 (22.2-34.0) ^{a,b}	20,950 (17,600-32,700) ^{a,b}	703,500 (599,000-900,000) ^{a,b}	31.6 (30.3-32.8)	8.85 (7.0-10.6) ^{a,b}	133.0 (37.0-3,000.0)
Puerperium stage						
L1	29.5 (20.3-42.0) ^{a,b}	20,700 (7,500-31,000) ^{a,b}	691,000 (270,000-999,000) ^{a,b}	31.5 (28.6-33.0)	9.1 (7.0-11.9) ^{a,b}	98.5 (36.0-2,075.0)
L2	33.2 (29.3-41.3)	16,000 (7,300-28,000)	673,000 (439,000-834,000)	30.95 (29.6-32.8)	10.1 (9.2-12.2)	102.0 (46.0-2,221.0)
L3	38.6 (31.8-46.1)	13,050 (9,100-22,100)	594,000 (496,000-800,000)	31.9 (29.1-33.6)	11.85 (10.4-13.9)	153.0 (43.0-1826.0)
L4	37.85 (32.3-49.0)	13,050 (7,300-16,600)	572,500 (403,000-889,000)	31.1 (29.6-33.4)	11.80 (10.5-15.5)	115.5 (45.0-240.0)

P1: first week after mating, P2: subsequent 45 days, P3: last week before whelping, L1: D0 (day of whelping)-D7 (7th day after whelping), L2: D8-D21, L3: D22-D42, L4: D43-D84.

MCHC: mean corpuscular haemoglobin concentration.

a: $P < 0.05$ for mean of the stage compared to mean of all other stages (bar P3 or L1), b: $P < 0.05$ for mean of peri-parturient period (P3 and L1) compared to mean of all other stages.

Table III.iii. Mean (median) values of leucocyte types in clinically healthy Beagle-breed female dogs, during pregnancy and the *puerperium*.

	Mature neutrophils		Immature neutrophils		Lymphocytes		Monocytes		Eosinophils	Basophils
	(%)	(cells μL^{-1})	(%)	(cells μL^{-1})	(%)	(cells μL^{-1})	(%)	(cells μL^{-1})	(%)	(%)
Pregnancy stage										
P1	70.0	8,470	2.0	208	25.5	3,102	3.0	435	0.0	0.0
	(54.0-82.0)	(6,966-11,310)	(0.0-11.0)	(0-1,364)	(12.0-34.0)	(1,488-4,216)	(0.0-9.0)	(0-1,089)	0.0-1.0	0.0-0.0
P2	68.5	9,520	2.0	368	24.5	3,627	4.0	560	0.0	0.0
	(58.0-83.0)	(5,415-22,278)	(0.0-12.0)	(0-1,584)	(11.0-33.0)	(1,551-4,902)	(0.0-11.0)	(0-1,573)	0.0-2.0	0.0-0.0
P3	75.0	15,161	1.0	248	18.0	4,439	3.0	583630	0.0	0.0
	(62.0-85.0)	(13,896-24,852) ^{a,b}	(0.0-11.0)	(0-2,332)	(12.0-33.0)	(2,040-7,227) ^{a,b}	(0.0-8.0)	(0-2,616) ^{a,b}	0.0-0.0	0.0-0.0
Puerperium stage										
L1	71.0	13,987	2.0	394	23.0	4,116	4.0	624	0.0	0.0
	(43.0-86.0)	(4,725-26,040) ^{a,b}	(0.0-10.0)	(0-2,740)	(10.0-40.0)	(2,230-10,138) ^{a,b}	(0.0-11.0)	(0-3,020) ^{a,b}	0.0-2.0	0.0-1.0
L2	71.0	11,400	2.0	272	23.0	3,296	3.0	510	0.0	0.0
	(45.0-86.0)	(4,230-24,080)	(0.0-70)	(0-976)	(10.0-35.0)	(1,971-6,293)	(0.0-13.0)	(0-2,171)	0.0-2.0	0.0-0.0
L3	74.5	9,520	2.0	243	20.0	2,600	3.0	392	0.0	0.0
	(63.0-84.0)	(5,733-16,575)	(0.0-15.0)	(0-2,565)	(12.0-32.0)	(1,582-4,437)	(0.0-6.0)	(0-786)	0.0-1.0	0.0-0.0
L4	74.0	9,577	2.0	243	21.0	2,575	4.0	514	0.0	0.0
	(59.0-84.0)	(4,380-13,612)	(0.0-15.0)	(0-1,015)	(11.0-34.0)	(979-4,212)	(0.0-6.0)	(0-870)	0.0-1.0	0.0-0.0

P1: first week after mating, P2: subsequent 45 days, P3: last week before whelping, L1: D0 (day of whelping)-D7 (7th day after whelping), L2: D8-D21, L3: D22-D42, L4: D43-D84.

a: $P < 0.05$ for mean of the stage compared to mean of all other stages (bar P3 or L1), b: $P < 0.05$ for mean of peri-parturient period (P3 and L1) compared to mean of all other stages.

Blood biochemical parameters

There was strong evidence that, during the peri-parturient period, total protein ($P<0.001$) (Fig. III.5), albumin ($P<0.001$) and total calcium ($P<0.001$) concentrations decreased, whilst alkaline phosphatase ($P=0.003$), C-reactive protein ($P<0.001$) (Fig. III.6) and calcium ion ($P=0.012$) concentrations increased. Significantly increased C-reactive protein concentrations were first detected 36 days before whelping. There was no evidence for an effect of the stage of pregnancy or the *puerperium* on globulin ($P=0.23$), magnesium ($P=0.16$) or glucose ($P=0.24$) concentrations. Detailed results are in Table III.iv.

Figure III.5. Scatterplot of total protein blood concentration (predicted mean and 95% confidence intervals) in clinically healthy Beagle-breed female dogs, during pregnancy and the *puerperium* (0: day of whelping).

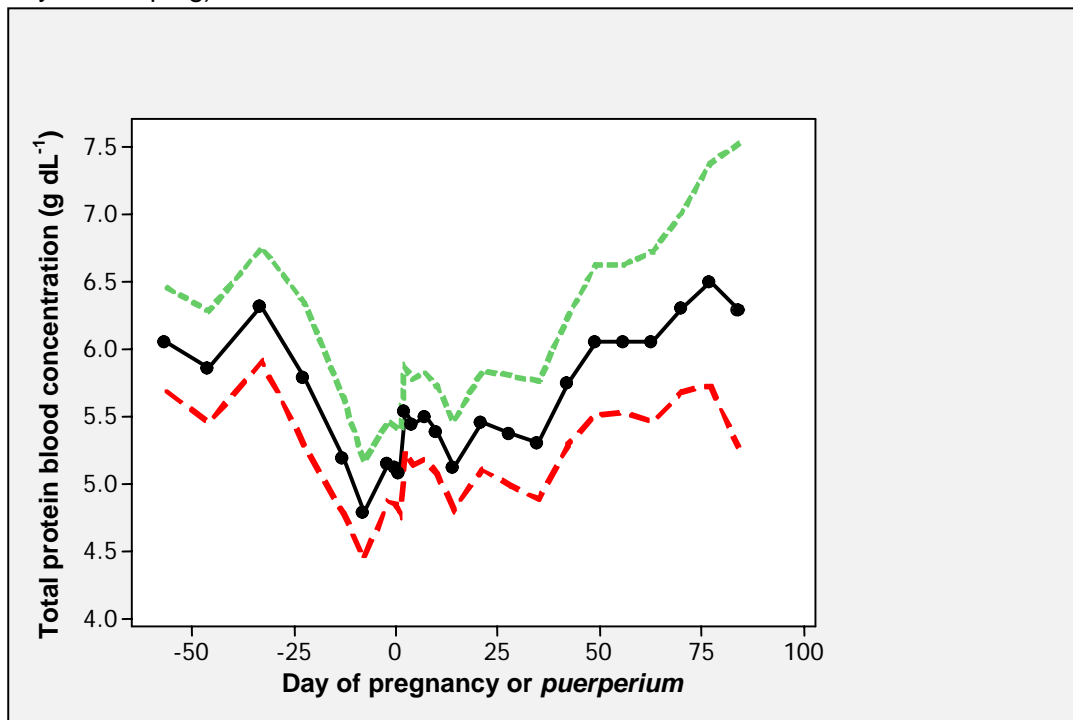
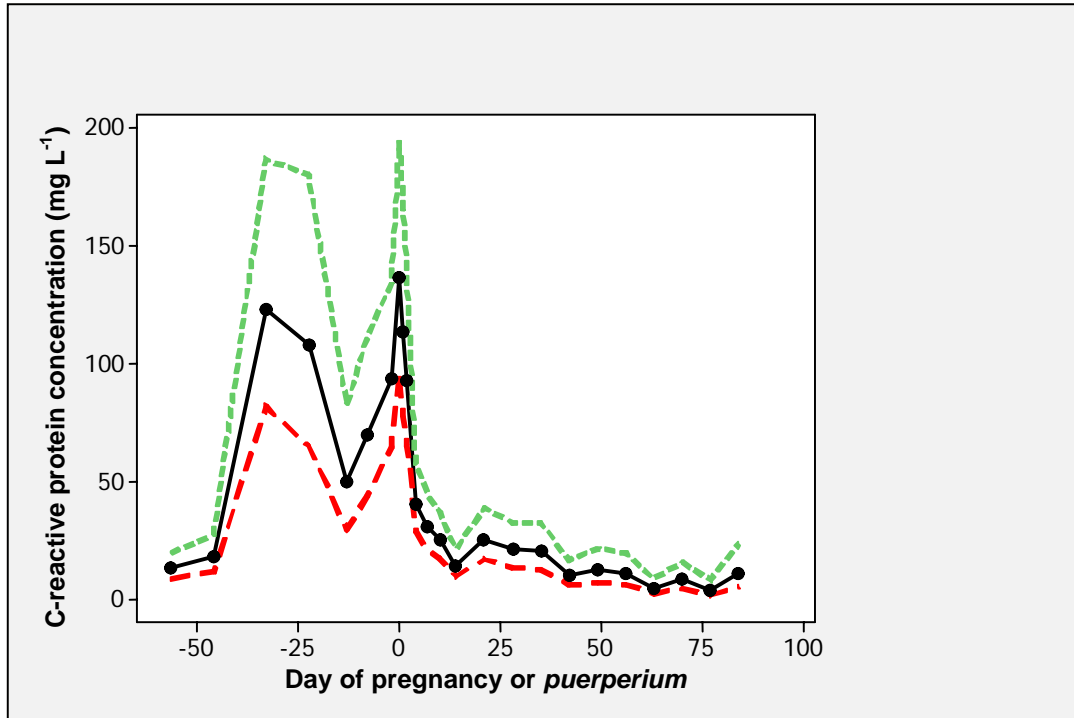

Figure III.6. Scatterplot of C-reactive protein blood concentration (predicted mean and 95% confidence intervals) in clinically healthy Beagle-breed female dogs, during pregnancy and the *puerperium* (0: day of whelping).



Range of values for parameters during the peri-parturient period

Table III.v presents a proposed range of 'reference' values during the peri-parturient period (last week of pregnancy and first week of the *puerperium*). This applied to parameters, for which values during that period were found to be outside the established 'reference' values in dogs (Bush 1993; Meyer and Harvey 1998; Sodikoff 2001, Ceron et al. 2005).

Table III.iv. Mean (median) values of blood biochemical tests in clinically healthy Beagle-breed female dogs, during pregnancy and the *puerperium*.

	Total protein concentration (g dL ⁻¹)	Albumin concentration (g dL ⁻¹)	Globulin concentration (g dL ⁻¹)	Alkaline phosphatase activity (u L ⁻¹)	Glucose concentration (mg dL ⁻¹)	C-reactive protein concentration (mg L ⁻¹)	Calcium-ion concentration (mg dL ⁻¹)	Total calcium concentration (mg dL ⁻¹)	Magnesium-ion concentration (mg dL ⁻¹)
Pregnancy stage									
P1	6.0 (5.8-6.5)	3.2 (2.7-3.4)	3.0 (2.6-3.5)	78.0 (69.0-131.0)	93.2 (43.5-109.1)	14.35 (8.7-25.0)	1.05 (0.90-1.25)	10.20 (8.85-11.01)	2.01 (1.76-2.39)
P2	6.0 (5.0-7.0)	2.7 (1.9-3.4)	3.2 (2.2-4.3)	100.0 (57.0-238.0)	104.1 (66.7-131.3)	73.4 (11.6-233.8) ^a	1.19 (0.92-1.65)	9.70 (8.64-10.95)	1.99 (1.71-2.21)
P3	5.0 (4.2-5.8) ^{a,b}	2.0 (1.7-2.5) ^{a,b}	2.9 (2.3-3.8)	109.0 (60.0-216.0) ^{a,b}	111.8 (83.1-130.5)	82.0 (35.4-183.4) ^{a,b}	1.20 (0.87-1.45)	8.93 (7.90-9.56) ^{a,b}	2.00 (1.53-2.28)
Puerperium stage									
L1	5.2 (4.2-8.0) ^b	2.1 (1.5-2.8) ^{a,b}	3.1 (2.4-4.1)	112.0 (63.0-303.0) ^{a,b}	103.4 (53.6-152.9)	79.8 (3.5-253.0) ^{a,b}	1.14 (0.73-1.63)	9.42 (8.25-10.88) ^{a,b}	1.88 (1.37-2.32)
L2	5.2 (4.1-6.2)	2.3 (1.5-2.6)	3.1 (2.3-4.1)	103.5 (54.0-294.0)	100.9 (45.3-123.7)	20.3 (3.2-133.8)	1.13 (0.83-1.94)	9.79 (8.21-11.13)	1.84 (1.44-2.30)
L3	5.3 (4.2-6.4)	2.0 (1.5-3.0)	3.4 (2.3-3.7)	111.5 (98.0-453.0)	106.3 (43.6-128.1)	23.9 (1.9-55.5)	1.01 (0.45-1.49)	9.92 (8.60-10.83)	1.81 (1.59-2.40)
L4	6.0 (4.9-6.8)	2.8 (1.9-3.4)	3.3 (2.8-3.6)	109.0 (92.0-162.0)	101.1 (63.4-135.7)	13.2 (0.9-33.1)	0.94 (0.78-1.19)	10.11 (9.04-10.92)	2.03 (1.79-2.22)

P1: first week after mating, P2: subsequent 45 days, P3: last week before whelping, L1: D0 (day of whelping)-D7 (7th day after whelping), L2: D8-D21, L3: D22-D42, L4: D43-D84.

a: $P < 0.05$ for mean of the stage compared to mean of all other stages (bar P3 or L1), b: $P < 0.05$ for mean of peri-parturient period (P3 and L1) compared to mean of all other stages.

Table III.v. A proposed range of values for haematological and blood biochemical parameters in dogs during the peri-parturient period, when a significant effect of that period on the values was evident.

Parametre	Proposed range of values during the peri-parturient period	Minimum-maximum values recorded during the study	Established range of 'reference' values (1, 2, 3, 4)
Haematocrit (%)	24.1-35.3	20.3-42.0	37.0-55.0 (1,2)
Leucocyte counts (cells μL^{-1})	13,200-31,400	7,500-32,700	6,000-15,000 (1) or 6,000-17,000 (2)
Thrombocyte counts (particles μL^{-1})	502,000-912,000	270,000-999,000	150,000-500,000 (1) or 160,000-430,000 (2)
Haemoglobin concentration (g dL^{-1})	7.7-10.6	7.0-11.9	12.0-19.0 (1, 2)
Mature neutrophil counts (cells μL^{-1})	8,500-25,200	4,725-26,040	3,000-11,500 (1, 2)
Lymphocyte counts (cells μL^{-1})	2,200-7,500	2,040-10,138	1,500-5,000 (1) or 1,000-4,800 (2)
Total protein concentration (g dL^{-1})	4.3-6.4	4.2-8.0	5.5-7.8 (1) or 5.4-7.1 (2)
Albumin concentration (g dL^{-1})	1.7-2.6	1.5-2.8	2.5-3.6 (1, 2)
C-reactive protein concentration (mg l^{-1})	30.0-180.0	3.5-253.0	<10.0-16.0 (3)

Peri-parturient period: last week of pregnancy and first week of the *puerperium*. Only parameters, for which values during that period were found to be outside the established 'reference' values in dogs, are included in the table.

References: (1) Bush 1993, (2) Meyer and Harvey 1998, (3) Sodikoff 2001, (4) Ceron et al. 2005.

Blood serum progesterone concentration

Median value of blood serum progesterone concentration in the animals during the *puerperium* was 0.43 ng mL⁻¹ (all measurements taken into account) There were no significant differences in the progesterone concentrations across the four stages ($P < 0.08$). However, differences between values of progesterone concentration in [L1+L2] period (median: 0.48 ng mL⁻¹) were significantly greater than values in [L3+L4] period (median: 0.32 ng mL⁻¹) ($P = 0.013$); values in [L1+L2] were higher than values in [L3+L4] in both animals with large (medians: 0.46 ng mL⁻¹ and 0.39 ng mL⁻¹, respectively; $P = 0.012$) or animals with small (medians: 0.48 ng mL⁻¹ and 0.30 ng mL⁻¹, respectively; $P = 0.046$). Values ≥ 1.0 ng mL⁻¹ were recorded in four samples, collected up to D14 from three different animals There were no differences between animals with large or small litters ($P < 0.07$) in any stage. Detailed results are in Table III.vi.

Table III.vi. Median (range) blood progesterone concentrations in clinically healthy Beagle-breed female dogs, during the *puerperium*.

<i>Puerperium</i> stage	Blood progesterone concentration (ng mL ⁻¹) of all bitches
L1	0.48 (0.13-1.10)
L2	0.42 (0.10-1.01)
L3	0.32 (0.25-0.55)
L4	0.33 (0.12-0.55)
Blood progesterone concentration (ng mL ⁻¹) of bitches with large litters	
L1	0.46 (0.13-1.10)
L2	0.38 (0.12-1.01)
L3	0.40 (0.28-0.55)
L4	0.30 (0.12-0.55)
Blood progesterone concentration (ng mL ⁻¹) of bitches with small litters	
L1	0.49 (0.33-1.00)
L2	0.45 (0.10-1.01)
L3	0.30 (0.25-0.49)
L4	0.33 (0.15-0.47)

L1: D0 (day of whelping)-D7 (7th day after whelping), L2: D8-D21, L3: D22-D42, L4: D43-D84.
Large litters: litters with 7-9 puppies, small litters: litters with 4-5 puppies.

Clinical and ultrasonographic findings in the genital system

Clinical observations

Vaginal discharge was observed in all animals in the study, on at least one occasion. In L1, discharge was evident in 48/59 occasions; in L2, it was evident in 15/27, in L3, in 5/18 and in L4, in 3/18 occasions (total: 71/122, 58% of sampling occasions). Discharge was observed continuously up to D21 and intermittently up to D77. The quantity of discharge present was always 'scanty' to 'small' amount. Initially, the discharge was thick and dark brown to green (up to D2) (Fig. III.7), progressively becoming mucous and brownish to red (up to D7) to serous and pink (D14 and D21) (Fig. III.8) to clear and colourless (D21 and subsequently) (Fig. III.9). The discharge was never malodorous. Frank haemorrhage was never recorded.

Consistency of the uterus was hard to mildly hard on most occasions in palpation through the abdominal wall during the *puerperium*. No pain reaction was observed, nor presence of fluid in the uterus was recorded. Median diameter of the body of the uterus, as estimated during palpation through the abdominal wall, was progressively reduced during the *puerperium*; it was estimated at ~3.0 cm on D0 to <1.0 cm on D28 and subsequently ($P=0.01$). A similar significant progressive decrease was also found in bitches with large or small litters ($P<0.03$); differences between bitches with large or small litters were not significant ($P>0.08$). Detailed results are in Table III.vii.

Median value of dimensions of the vulva during the *puerperium* were as follows (all measurements taken into account): total horizontal width × total vertical length = 2.7 cm × 3.4 cm; median value of distance from anus to upper vulval commissure (all measurements taken into account) was 8.0 cm. There were significant differences in the results of measurements among the four periods defined (total horizontal width: $P=0.063$, total vertical length: $P<0.001$, distance from anus to upper vulval commissure: $P=0.003$). Moreover, differences between median values of the above measurements in [L1+L2] period (median total horizontal width: 2.7 cm, median total vertical length: 3.5 cm, median distance from anus to upper vulval commissure: 8.2 cm) were significantly greater than the median values in [L3+L4] period (median total horizontal width: 2.5 cm, median total vertical length: 3.2 cm, median distance from anus to upper vulval commissure: 7.2 cm) (total horizontal width: $P=0.016$, total vertical length: $P<0.001$, distance from anus to upper vulval commissure: $P=0.001$). Finally, there were significant differences between animals with large or small litters (total horizontal width: $P=0.011$, total vertical length: $P=0.009$, distance from anus to upper vulval commissure: $P=0.144$). Detailed results are in Table III.viii.

Figure III.7. Presence of thick vaginal discharge (small amount, brown colour) in a clinically healthy Beagle-breed female dog, on D1 of the *puerperium*.



Figure III.8. Presence of serous vaginal discharge (small amount, pink colour) in a clinically healthy Beagle-breed female dog, on D10 of the *puerperium*.



Figure III.9. Presence of clear vaginal discharge (scanty amount, colourless) in a clinically healthy Beagle-breed female dog, on D21 of the *puerperium*.



Table III.vii. Results (median, range) of estimation of the diameter of the body of the uterus during palpation through the abdominal wall in clinically healthy Beagle-breed female dogs, during the *puerperium*.

<i>Puerperium</i> stage	Diameter (cm) of the body of the uterus of all bitches
L1	2.5 (1.5-4.0) ^a
L2	1.25 (0.5-2.5) ^a
L3	1.0 (0.5-1.5) ^a
L4	0.75 (0.5-1.0) ^a
Diameter (cm) of the body of the uterus of bitches with large litters	
L1	2.5 (1.5-4.0) ^a
L2	1.25 (0.5-2.0) ^a
L3	1.0 (0.5-1.5) ^a
L4	0.5 (0.5-1.0) ^a
Diameter (cm) of the body of the uterus of bitches with small litters	
L1	2.5 (2.0-4.0) ^a
L2	1.25 (1.0-2.5) ^a
L3	1.0 (0.5-1.0) ^a
L4	0.75 (0.5-1.0) ^a

L1: D0 (day of whelping)-D7 (7th day after whelping), L2: D8-D21, L3: D22-D42, L4: D43-D84.

Large litters: litters with 7-9 puppies, small litters: litters with 4-5 puppies.

a: progressive changes during the study $P < 0.05$.

Table III.viii. Results (median, range) of measurements carried out in the external genitalia of clinically healthy Beagle-breed female dogs, during the *puerperium*.

<i>Puerperium</i> stage	Dimensions of the vulva (cm)		Distance (cm) from anus to upper vulval commissure
	total horizontal width	total vertical length	
All bitches			
L1	2.6 (1.4-4.0) ^a	3.5 (2.9-4.8) ^a	8.5 (6.4-12.7) ^a
L2	2.8 (1.8-3.8) ^a	3.5 (2.9-4.5) ^a	8.2 (6.1-9.3) ^a
L3	2.7 (2.1-3.2) ^a	3.2 (2.9-4.0) ^a	7.0 (5.6-9.2) ^a
L4	2.4 (2.2-3.3) ^a	3.1 (2.7-3.6) ^a	7.5 (5.0-8.5) ^a
Bitches with large litters			
L1	3.0 (2.2-3.8) ^a	3.6 (3.2-4.8) ^a	8.15 (6.4-10.2) ^a
L2	2.8 (2.4-3.6) ^a	3.5 (3.0-4.5) ^a	8.2 (6.1-9.2) ^a
L3	2.7 (2.1-3.0) ^a	3.2 (2.9-3.7) ^a	7.2 (6.1-9.0) ^a
L4	2.4 (2.2-2.7) ^a	3.3 (2.7-3.6) ^a	7.0 (5.0-8.5) ^a
Bitches with small litters			
L1	2.5 (1.4-4.0) ^a	3.5 (2.9-4.5) ^a	8.5 (6.5-12.7) ^a
L2	2.7 (1.8-3.8) ^a	3.4 (2.9-3.7) ^a	8.1 (6.5-9.3) ^a
L3	2.7 (2.4-3.2) ^a	3.3 (2.9-4.0) ^a	7.0 (5.6-9.2) ^a
L4	2.5 (2.2-3.3) ^a	3.0 (2.8-3.3) ^a	7.7 (6.4-8.4) ^a

L1: D0 (day of whelping)-D7 (7th day after whelping), L2: D8-D21, L3: D22-D42, L4: D43-D84.

Large litters: litters with 7-9 puppies, small litters: litters with 4-5 puppies.

a: progressive changes during the study $P < 0.05$.

Ultrasonographic findings

Up to D21, the uterus appeared oedematous, with a heterogeneous echopattern (Fig. III.10). Until that time, it was easy to recognize and image the organ, because width of the uterine horns was estimated to be ≥ 1.0 cm. After that day, it was more difficult to image it, as their width was progressively decreasing (Fig. III.11) and, on D70, was estimated to be 0.6 to 0.7 cm (Fig. III.12). Width of uterine horns imaged progressively decreased ($P < 0.001$); similar findings were evident in animals with large or small litters ($P < 0.03$). Differences between results imaged in animals with large or small litters were not statistically significant ($P < 0.24$). Width of uterine horns (all animals, all stages of the *puerperium*) was not found to be significantly different at placental sites and at interplacental areas ($P = 0.175$); similarly, no differences were also significant in animals with large or small litters ($P = 0.211$ and $P = 0.169$, respectively). However, when only measurements obtained during L2 and L3 were considered (all animals), differences in width of uterine horns at placental sites (median: 1.4, range: 0.8-2.6 cm) and at interplacental areas (median: 1.2, range: 0.7-1.7 cm) were significant ($P = 0.041$). Detailed results are in Table III.ix.

In longitudinal images, the uterus appeared consistently cylindrical in shape. In transverse images taken up to D21, the sections of the organ appeared polygonal to compressed circular to circular; in transverse images taken after D21, they appeared consistently circular.

There was evidence of a hypoechoic rim, with a more echogenic inner architecture. In some images, the anechoic lumen was barely visible, because of the more echogenic content, whilst in others, it was observed greatly contrasting to the hyperechoic endometrium. On 12/122 examination occasions, the uterine lumen was anechoic in all images taken in the same animal; on 47/122 occasions, the uterine lumen was echogenic in all images taken in the same animal. The placental sites appeared as granulated structures of medium echogenicity, with small anechoic areas. Initially, the uterine wall was imaged as a multi-layer structure (up to five layers plus the lumen could be imaged) (Fig. III.10). Then, up to D42, at least two separate layers, were consistently observed (Fig. III.11). Subsequently to that, in most cases, the echopattern of the uterine wall was finely textured, homogeneous and hypoechoic to moderately echogenic (Fig. III.12); nevertheless, in one animal separate layers could be observed on D49. The progressive decrease of number of layers imaged was significant ($P < 0.001$); differences between results imaged in animals with large or small litters were not statistically significant ($P = 0.43$). Detailed results are in Table III.ix.

At imaging, mean thickness of the endometrium was found 0.5 cm at placental sites and 0.5 cm at interplacental areas (median, range: 0.5, 0.3-1.7 and 0.5, 0.3-0.8, respectively) (all measurements taken into account) ($P = 0.834$). Also, mean thickness of the myometrium was found 0.5 cm at placental sites and 0.5 cm at interplacental areas (median, range: 0.5, 0.2-0.9 and 0.5, 0.2-0.9, respectively) (all measurements taken into account) ($P = 0.698$). Imaged thickness of endometrium and myometrium was found to progressively decrease ($P < 0.001$); similar findings were evident in animals with large or small litters ($P \leq 0.002$). Differences between results of imaging measurements of endometrium and myometrium in animals with large or small litters were not statistically significant ($P = 0.811$ and $P = 0.745$ for the endometrium and the myometrium, respectively). Detailed results are in Table III.ix.

At imaging, diameter of the lumen of uterine horns was found to progressively decrease during the study ($P = 0.003$); similar findings were evident in animals with large or small litters ($P = 0.011$ and $P = 0.039$, respectively). Differences between results of imaging measurements of diameter of the lumen of uterine horns in animals with large or small litters were not statistically significant ($P = 0.394$). Detailed results are in Table III.ix.

The ovaries were observed caudally or caudolaterally to the caudal pole of each kidney. They could not be always visualized, because of their small size, the presence of adipose tissue

(bursa) and gas (bowels) in the region, as well as due to their superficial location. They appeared to be small and ovoid with smooth texture. They were imaged as homogeneous structures with medium to low echogenicity with no visible features (e.g., follicles) on them (Fig. III.13).

Figure III.10. Ultrasonographic view of the uterus of a clinically healthy Beagle-breed female dog, on D2 of the *puerperium*. Left figure: transverse image of an interplacental area showing hyperechoic endometrium (em); centre figure: transverse image of a placental site showing endometrium of intermediate echogenicity with hypoechoic foci therein and anechoic lumen (l); right figure: longitudinal image of uterine horn with a placental site (ps) appearing as granulated structure of medium echogenicity, with small anechoic areas, and an interplacental area (ipa) with increased echogenicity and homogeneous appearance. The myometrium (mm) appeared less echogenic compared to the endometrium. A multi-layer (6) structure of the uterine wall was evident. Images taken on a MyLab® 30 ultrasonography system with linear transducer 10.0 MHz and scanning depth 70 mm for the transverse images and 40 mm for the longitudinal image.

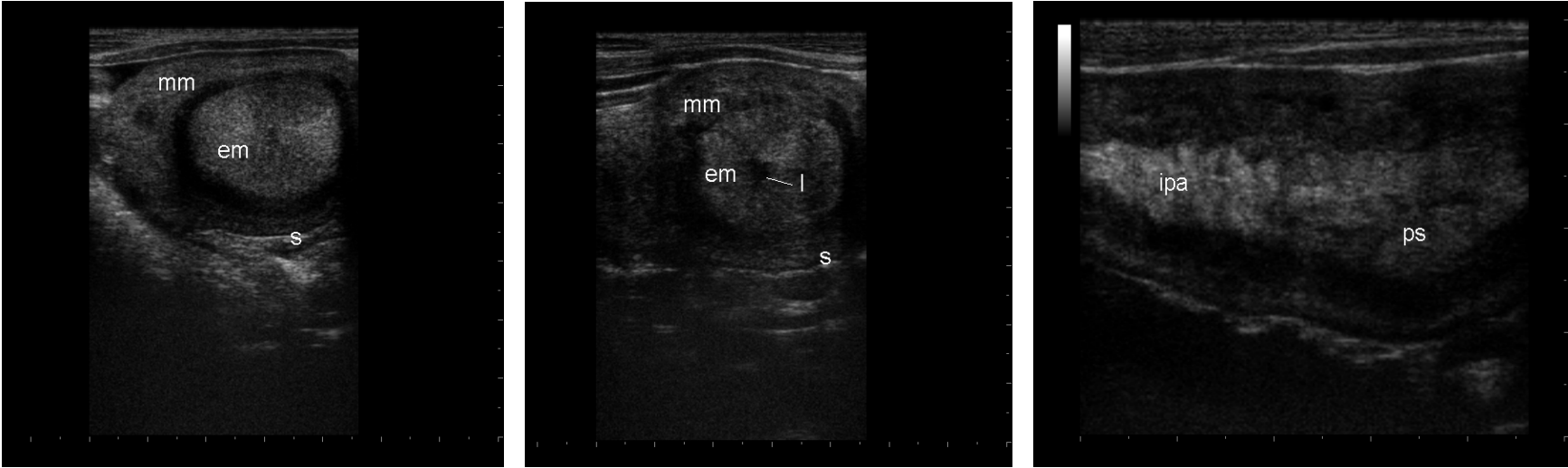

em: endometrium, ipa: interplacental area, l: uterine lumen, mm: myometrium, ps: placental site, s: serosa.

Figure III.11. Ultrasonographic view of the uterus of a clinically healthy Beagle-breed female dog, on D28 of the *puerperium*. Left figure: transverse image of an interplacental area showing hyperechoic endometrium (em) with content-containing lumen (l); centre figure: transverse image of a placental site showing endometrium of intermediate echogenicity with anechoic lumen (l); right figure: longitudinal image of uterine horn with a placental site (ps) appearing as granulated structure of medium echogenicity, with some anechoic areas, and an interplacental area (ipa) with a more homogeneous appearance. The myometrium (mm) appeared less echogenic compared to the endometrium. A multi-layer (4) structure of the uterine wall was evident. Images taken on a MyLab® 30 ultrasonography system with linear transducer 10.0 MHz and scanning depths 30 mm and 40 mm for the transverse images and 30 mm for the longitudinal image.

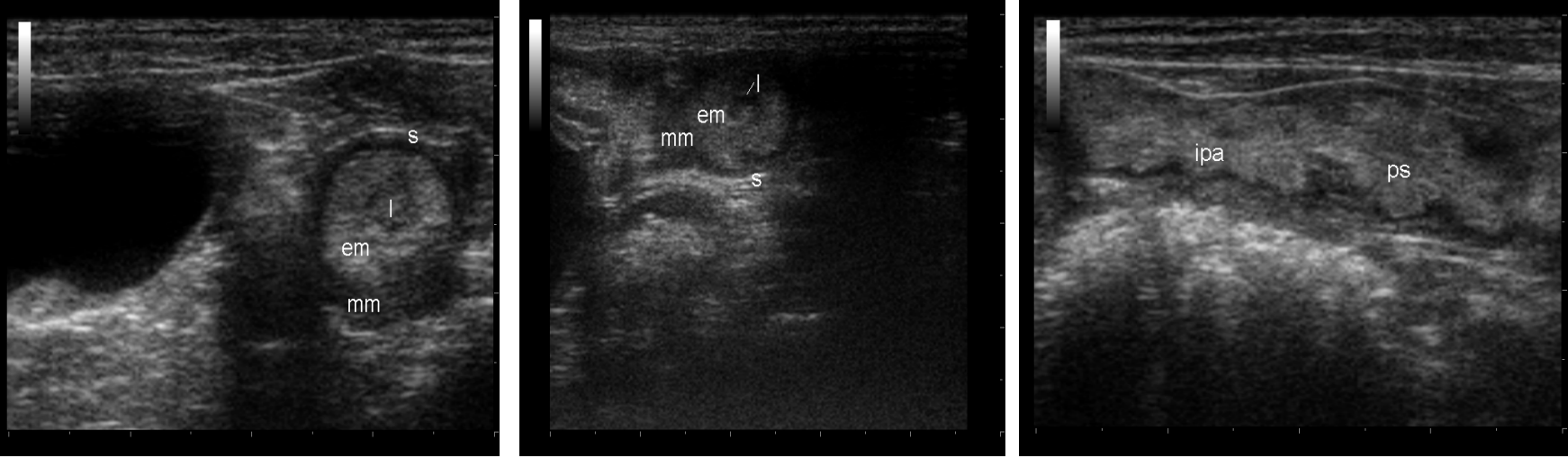

em: endometrium, ipa: interplacental area, l: uterine lumen, mm: myometrium, ps: placental site, s: serosa.

Figure III.12. Ultrasonographic view of the uterus of a clinically healthy Beagle-breed female dog, on D70 of the *puerperium*. Transverse images of hypoechoic uterus (u), through the acoustic window of urinary bladder (bl). Images taken on a AMI B7 ultrasonography system with convex transducer 6.0 MHz and scanning depth 80 mm.

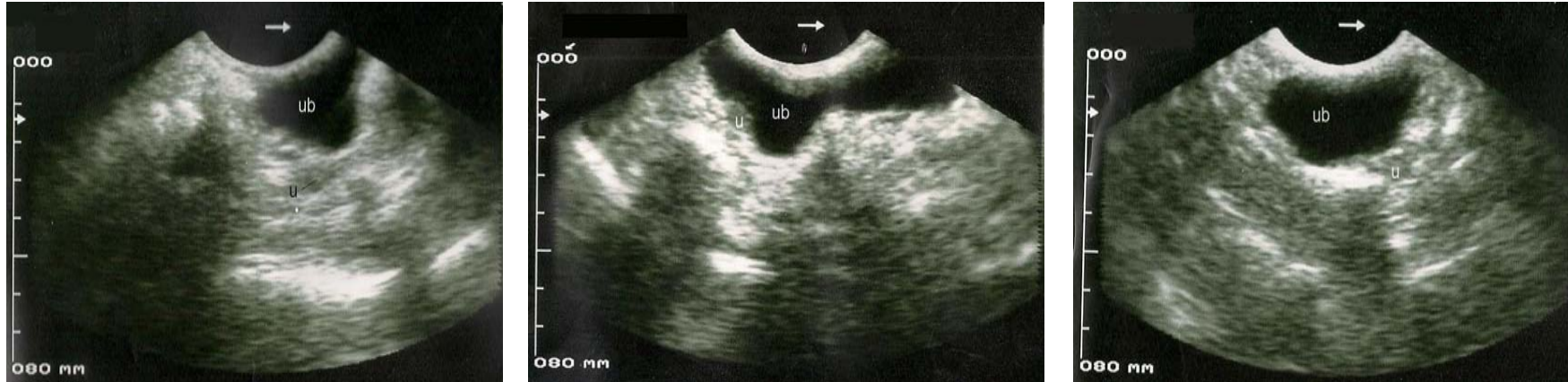

bl: urinary bladder, u: uterus.

Figure III.13. Ultrasonographic view of one ovary of two different clinically healthy Beagle-breed female dogs, on D28 (left image) or D63 (right image) of the *puerperium*. Longitudinal images of the ovary (ov) with low echogenicity and homogeneous consistence, with no specific features. Images taken on a MyLab[®] 30 ultrasonography system with linear transducer 10.0 MHz and scanning depth 50 mm and 30 mm for the left and right image respectively.

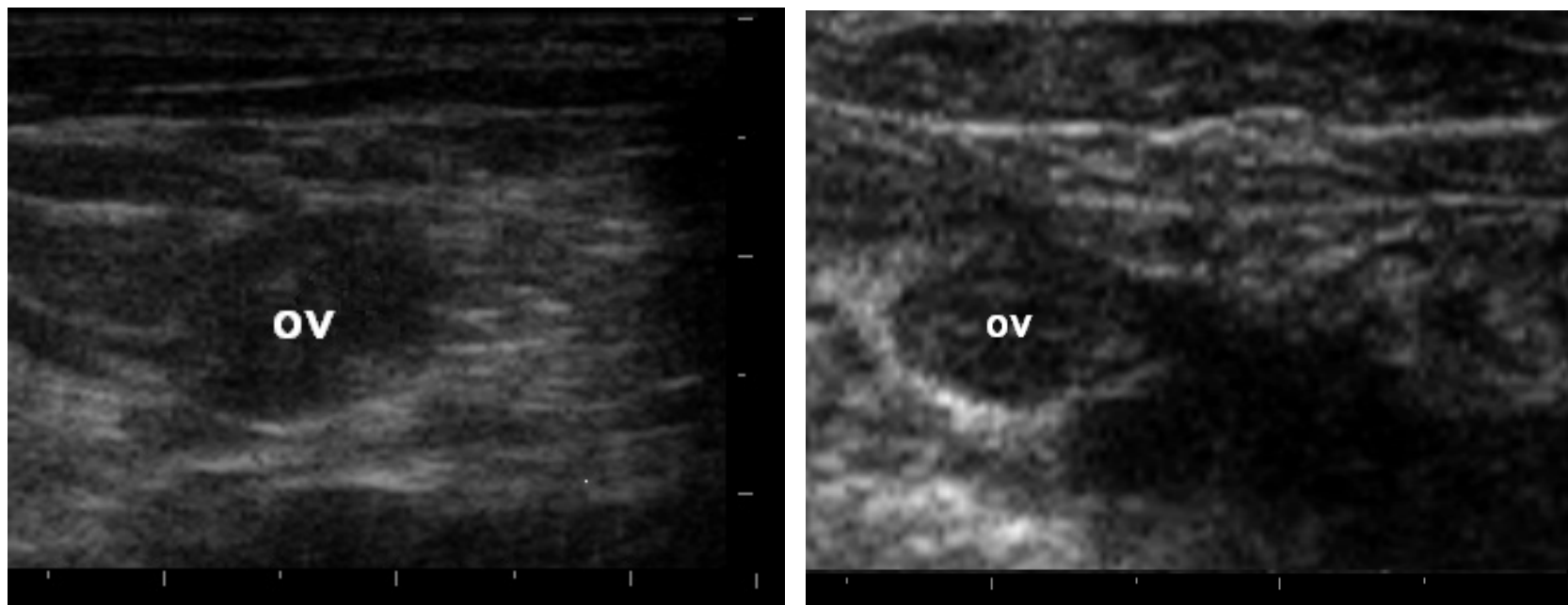

Table III.ix. Results (median, range) of measurements taken during ultrasonographic imaging of the uterus of clinically healthy Beagle-breed female dogs, during the *puerperium*.

<i>Puerperium</i> stage	Width of uterine horns (cm)		Number of layers observed during ultrasonographic examination of the uterus
	At placental sites	At interplacental areas	
All bitches			
L1	2.2 (1.5-4.2) ^a	1.9 (1.3-3.4) ^a	5 (5-5) ^a
L2	1.6 (1.0-2.6) ^a	1.3 (0.9-1.7) ^a	4 (4-5) ^a
L3	1.0 (0.8-1.1) ^a	0.8 (0.7-0.9) ^a	3 (2-4) ^a
L4	0.6 (0.6-0.7) ^a	0.6 (0.6-0.7) ^a	1 (1-3) ^a
Bitches with large litters			
L1	2.2 (1.5-4.2) ^a	2.0 (1.5-3.4) ^a	5 (5-5) ^a
L2	1.8 (1.3-2.6) ^a	1.3 (0.9-1.4) ^a	4.5 (4-5) ^a
L3	1.0 (0.8-1.0) ^a	0.8 (0.7-0.9) ^a	2.5 (2-4) ^a
L4	0.6 (0.6-0.7) ^a	0.6 (0.6-0.7) ^a	1 (1-1) ^a
Bitches with small litters			
L1	2.3 (1.7-3.5) ^a	1.8 (1.3-2.9) ^a	5 (5-5) ^a
L2	1.6 (1.0-2.1) ^a	1.2 (0.9-1.7) ^a	4 (4-5) ^a
L3	1.1 (1.0-1.1) ^a	0.8 (0.8-0.9) ^a	3 (2-4) ^a
L4	0.6 (0.6-0.7) ^a	0.6 (0.6-0.7) ^a	1 (1-3) ^a
<i>Puerperium</i> stage	Thickness of uterine wall (cm)		Diametre of uterine lumen (cm)
	Endometrium	Myometrium	
All bitches			
L1	0.6 (0.3-1.7) ^a	0.6 (0.3-0.9) ^a	0.4 (0.2-1.0) ^a
L2	0.4 (0.1-0.7) ^a	0.4 (0.2-0.8) ^a	0.4 (0.1-0.8) ^a
L3	0.2 (0.1-0.4) ^a	0.2 (0.2-0.3) ^a	0.2 (0.1-0.3) ^a
L4	0.2*	0.2*	0.2*
Bitches with large litters			
L1	0.6 (0.3-1.4) ^a	0.6 (0.3-0.9) ^a	0.5 (0.2-0.8) ^a
L2	0.4 (0.2-0.7) ^a	0.4 (0.2-0.7) ^a	0.4 (0.1-0.7) ^a
L3	0.2 (0.1-0.4) ^a	0.3 (0.2-0.3) ^a	0.2 (0.1-0.3) ^a
L4	_*	_*	_*
Bitches with small litters			
L1	0.6 (0.3-1.7) ^a	0.5 (0.4-0.9) ^a	0.4 (0.3-1.0)
L2	0.4 (0.1-0.5) ^a	0.3 (0.2-0.8) ^a	0.3 (0.2-0.8)
L3	0.2 (0.1-0.4) ^a	0.2 (0.2-0.3) ^a	0.2 (0.2-0.3)
L4	0.2*	0.2*	0.2*

L1: D0 (day of whelping)-D7 (7th day after whelping), L2: D8-D21, L3: D22-D42, L4: D43-D84.

Large litters: litters with 7-9 puppies, small litters: litters with 4-5 puppies.

a: progressive changes during the study $P < 0.05$.

*: during L4, clear imaging of different layers in the uterine wall was evident in only one animal in the study.

Bacteriological findings in vaginal samples

Frequency of bacterial isolation

In total, 122 samples from the anterior part of the vagina were examined bacteriologically. Of these, 51 (41%) yielded bacteria. Bacteria were isolated from at least one sample from each bitch on at least one occasion. Frequency of bacterial isolation from vaginal samples was 0.525 during L1, 0.333 during L2, 0.333 during L3 and 0.278 during L4 ($P=0.094$). Differences of frequency of L1 *versus* frequency of each of the other three periods were also increased ($P<0.1$). Detailed results are in Table III.x.

Median time to first infection after whelping was 0.25 days. Estimated median duration of infection (all infections taken into account) was 5.25 days (95% confidence limits: 0-13.0 d).

Table III.x. Results of bacteriological examination of samples from the anterior part of the vagina of clinically healthy Beagle-breed female dogs, during the *puerperium*.

<i>Puerperium</i> stage	Bacteriologically positive samples	Bacteriologically positive dogs
L1	31/59	11/12
L2	9/27	5/10
L3	6/18	4/7
L4	5/18	2/4
Total	51/122	12/12

L1: D0 (day of whelping)-D7 (7th day after whelping), L2: D8-D21, L3: D22-D42, L4: D43-D84.

Bacteriologically positive dog: a dog from which a microorganism was isolated from at least one vaginal sample on at least one occasion during the reference period.

Bacterial identity

On 47 occasions, bacteria were isolated in pure culture, whilst on 4 occasions, bacteria were isolated in mixed culture. Most of the organisms recovered were *Escherichia coli* and *Trueperella (Arcanobacterium) pyogenes*: 22 (40%) and 16 (29%), respectively, of the 55 isolates recovered (Table III.xi). Persistent bacterial isolation was recorded in five incidents (4 dogs); three cases involved *E. coli* and the other two involved *T. pyogenes*.

Table III.xi. Frequency of isolation of bacteria from samples from the anterior part of the vagina of clinically healthy Beagle-breed female dogs, during the *puerperium*.

Bacterial identity	Vaginal samples
<i>Escherichia coli</i>	22
<i>Pasteurella multocida</i>	6
<i>Staphylococcus aureus</i>	1
<i>Staphylococcus simulans</i>	2
<i>Streptococcus</i> spp.	7
<i>Streptococcus canis</i>	1
<i>Trueperella (Arcanobacterium) pyogenes</i>	16
Total	55

Cytological findings in vaginal samples

In total, samples were collected from the vagina and examined cytologically on 122 occasions. On each occasion, a smear from a swab from the anterior part of the vagina and a smear from a swab from the caudal part of the vagina were examined (i.e., 244 samples were studied).

In swab samples from the anterior part of the vagina, the majority (55%-60% in L1; 65%-75% in L2, L3, L4) of cells observed were uterine or vaginal epithelial cells. Uterine epithelial cells, normal or degenerated, were observed characteristically clustered (Fig. III.1), whilst vaginal cells observed were primarily parabasal (Figs III.15 and III.16) or small intermediate cells. Leucocytes were also observed in these smears; neutrophils (Fig. III.17) predominated (92%-95% in L1, L2 and L3; 85% in L4), whilst lymphocytes (3%-5% in L1, L2 and L3; 13% in L4) and macrophages (1%-2%) were also observed. Erythrocytes were also occasionally observed in all periods of the *puerperium*, whilst trophoblast-like cells (Fig. III.18) were also evident in L1 and L2.

Mean (median) cell counting scores in swab samples collected from the anterior vagina was 1.56 (1) for epithelial cells and 1.39 (1) for leucocytes (all measurements taken into account). Mean (median) cell counting scores in these swab samples collected during each *puerperium* stage were as follows: 1.36 (1) in L1, 1.62 (2) in L2, 1.83 (2) in L3 and 1.83 (2) in L4 for epithelial cells and 1.66 (1) in L1, 1.28 (1) in L2, 1.15 (1) in L3 and 1.00 (1) in L4 for leucocytes. There was strong evidence that the progressive increase in epithelial cell counting scores and the progressive decrease in leucocyte counting scores observed during the *puerperium* were significant ($P=0.016$ and $P=0.037$, respectively). Finally, there were no significant differences in epithelial cell counting scores ($P=0.210$) or leucocyte counting scores ($P=0.202$) between female dogs with large or small

litters. Detailed results are in Table III.xii.

Mean (median) cell counting scores for samples which had yielded bacteria (n=47), were 1.53 (1) and 1.6 (2) for epithelial cells and leucocytes, respectively. Respective mean (median) cell counting scores for samples which had not yielded bacteria (n=75), were 1.57 (1) and 1.20 (1). These differences were significant ($P=0.045$) for leucocyte counting scores, but not ($P=0.383$) for epithelial cell counting scores.

In swab samples from the outer part of the vagina, vaginal epithelial cells were mainly (>90%) observed. Vaginal cells observed were parabasal (55%-60% in L1; 40%-45% in L2, L3; 35%-40% in L4), small intermediate (~40% in L1, L2, L3; 50% in L4) or large intermediate (0%-5% in L1; 5%-15% in L2, L3, 10%-15% in L4) cells. During L1, uterine epithelial cells were also occasionally observed (5/12 dogs) in cases of presence of excessive amount of discharge in the genital tract. Leucocytes observed consisted primarily (>95%) of neutrophils.

Figure III.14. Uterine epithelial cells, characteristically clustered, in a swab sample from the anterior part of the vagina from a clinically healthy Beagle-breed female dog, on D4 of the *puerperium* (Giemsa, 40x objective, photograph taken on a Zeiss-Axiostar Microscope).

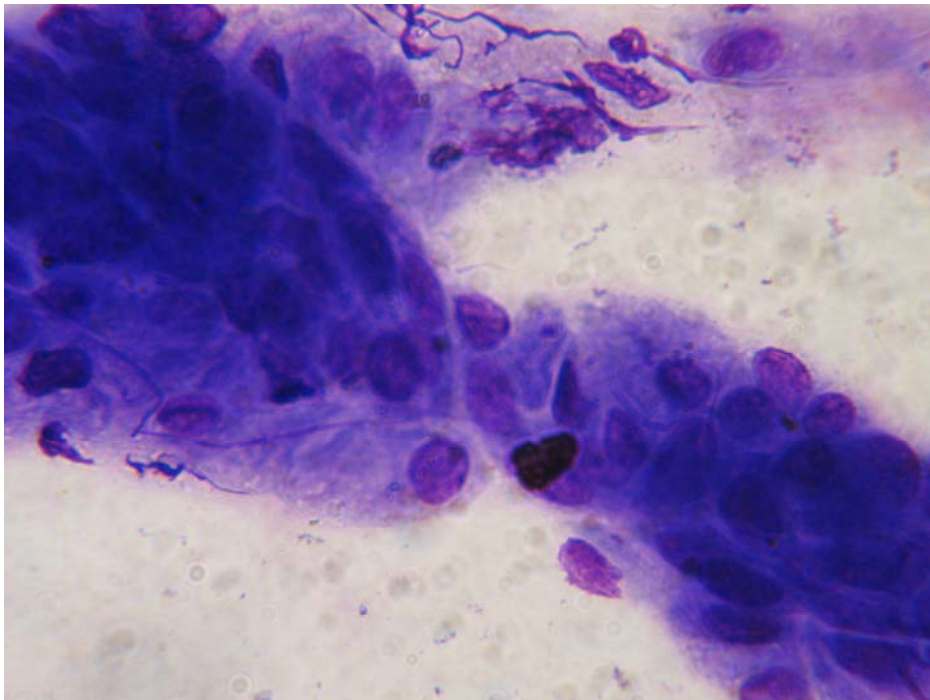

Figure III.15. Vaginal epithelial cells (parabasal cells) in a swab sample from the anterior part of the vagina from a clinically healthy Beagle-breed female dog, on D14 of the *puerperium* (Giemsa, 40x objective, photograph taken on a Zeiss-Axiostar Microscope).

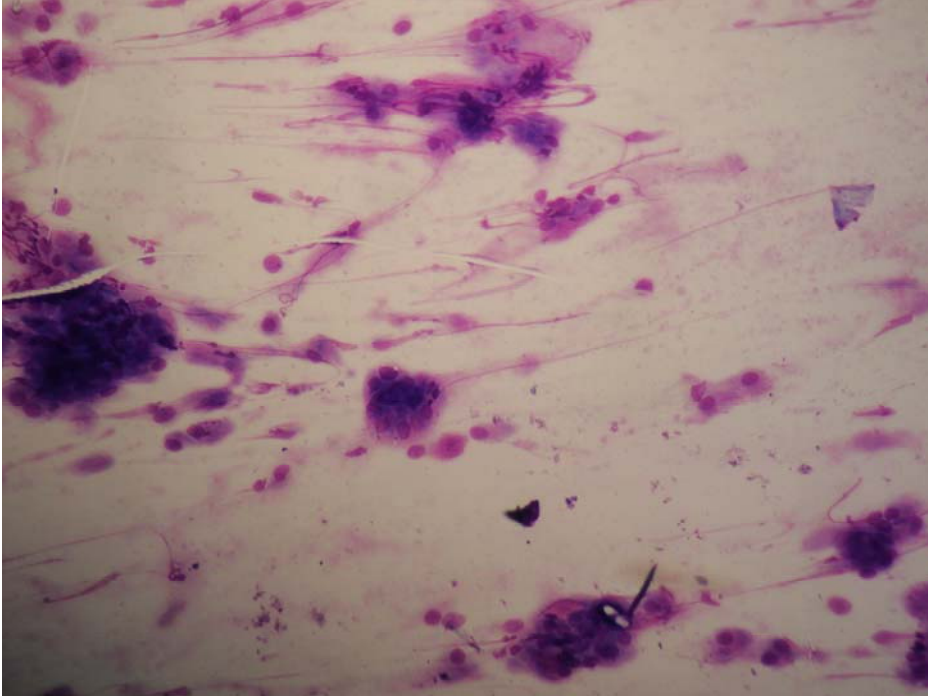

Figure III.16. Vaginal epithelial cells (parabasal cells) in a swab sample from the anterior part of the vagina from a clinically healthy Beagle-breed female dog, on D77 of the *puerperium* (Giemsa, 40x objective, photograph taken on a Zeiss-Axiostar Microscope).

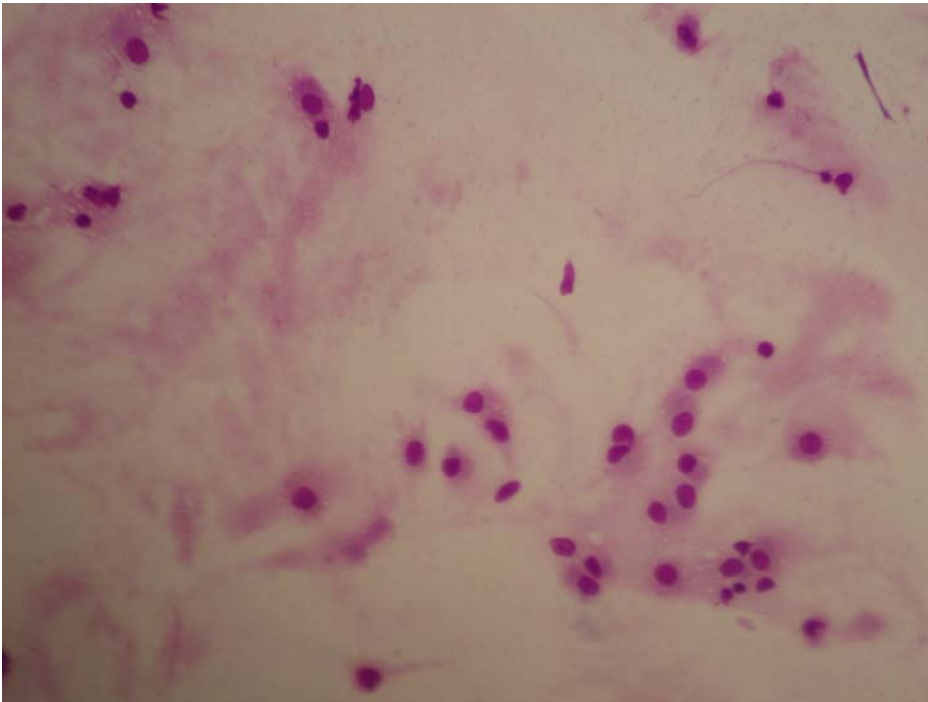

Figure III.17. Degenerated neutrophils in a swab sample from the anterior part of the vagina from a clinically healthy Beagle-breed female dog, on D2 of the *puerperium* (Giemsa, 100× objective, photograph taken on a Zeiss-Axiostar Microscope).

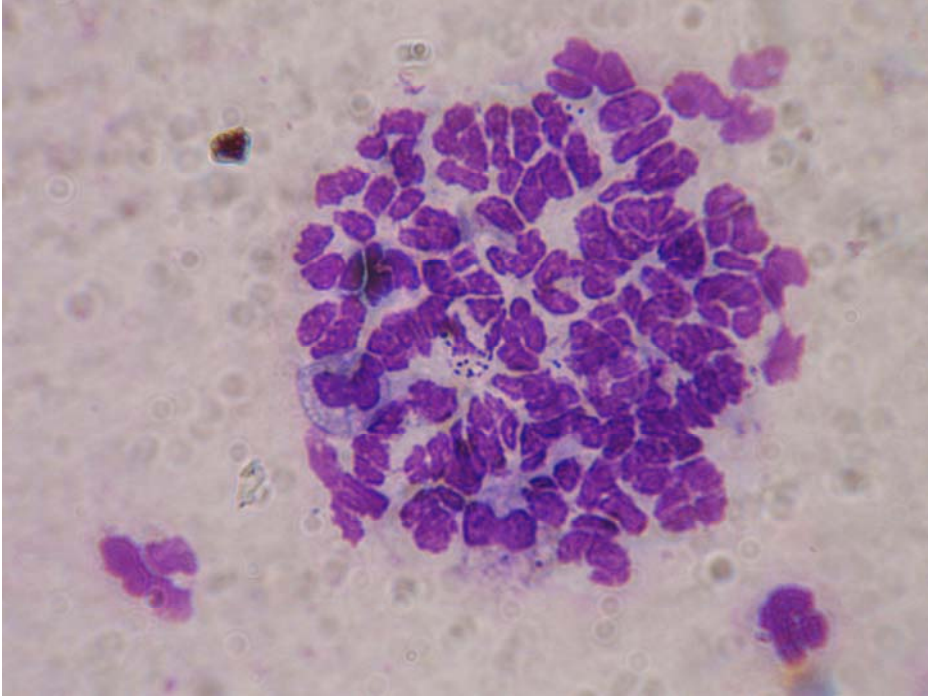

Figure III.18. Trophoblast-like cells in a swab sample from the anterior part of the vagina from a clinically healthy Beagle-breed female dog, on D2 of the *puerperium* (Giemsa, 40× objective, photograph taken on a Zeiss-Axiostar Microscope).

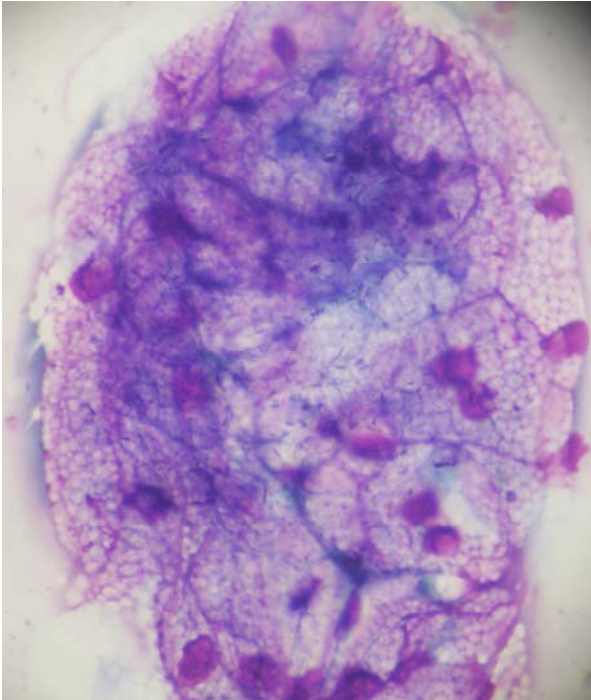

Table III.xii. Mean (median, range) of cell counting scores in swab smears from anterior vagina in clinically healthy Beagle-breed female dogs, during the *puerperium*.

<i>Puerperium</i> stage	Epithelial cell counting scores	Leucocyte counting scores
Cell count scores from all bitches		
L1	1.36 (1, 1-4) ^a	1.66 (1, 0-4) ^a
L2	1.62 (2, 1-3) ^a	1.28 (1, 0-3) ^a
L3	1.83 (2, 0-3) ^a	1.15 (1, 0-3) ^a
L4	1.83 (2, 0-3) ^a	1.00 (1, 0-2) ^a
Cell count scores from bitches with large litters		
L1	1.42 (1, 1-4) ^a	1.85 (2, 0-4) ^a
L2	1.57 (1.5, 1-3) ^a	1.29 (1, 0-3) ^a
L3	1.67 (2, 1-3) ^a	1.30 (1, 0-3) ^a
L4	1.80 (2, 0-3) ^a	1.20 (1, 0-2) ^a
Cell count scores from bitches with small litters		
L1	1.28 (1, 1-2) ^a	1.40 (1, 0-3) ^a
L2	1.67 (2, 1-2) ^a	1.00 (1, 0-2) ^a
L3	2.00 (2, 0-3) ^a	0.67 (1, 0-1) ^a
L4	2.20 (2.5, 1-3) ^a	0.63 (0.5, 0-2) ^a

L1: D0 (day of whelping)-D7 (7th day after whelping), L2: D8-D21, L3: D22-D42, L4: D43-D84.

Large litters: litters with 7-9 puppies, small litters: litters with 4-5 puppies.

Scoring scale: '0' (no cells observed in the slide), '1' (on average, ≤ 3 cells per optical field), '2' (on average, 4-7 cells per optical field), '3' (on average, 8-15 cells per optical field) and '4' (on average, ≥ 16 cells per optical field), using the 40 \times objective lens of a Zeiss-Axiostar Microscope.

a: progressive changes during the study $P < 0.05$.

Clinical and ultrasonographic findings in the mammary glands

Clinical observations

During the study, the mammary glands were soft and with homogeneous consistency. No abnormal findings (e.g., changes in mammary secretion which appeared normal throughout the study, enlargement of mammary glands etc.) were recorded in the mammary glands. In all bitches, from D14 or D21 onwards, mild abrasions were observed in the skin around the teat of 2 to 4 mammary glands, mainly in the R1 and R2 glands.

On D1, the mammary secretion was thick and yellowish, thereafter (occasionally on D2, but always on D4) becoming 'milky'. Subsequently to D56, it was not always possible to collect an adequate milk sample, because some mammary glands had partially involuted.

Ultrasonographic findings

During L1, L2 and L3, the mammary parenchyma showed, in general, a homogeneous consistency and medium echogenicity. During L4, in general, a less homogeneous echopattern was seen and lower (compared to previous periods) echogenicity was recorded; increased amount of connective tissue was also evident in ultrasonograms during that period. The teat was found to be moderately echogenic.

Occasionally, it was possible to image different lobules within the same mammary gland, separated by connective interlobular tissue. These were distinguished more clearly after D56. Moreover, occasionally, characteristically echogenic areas of different shapes ('white spots') were visible within the mammary parenchyma. Intra-parenchymatous vessels were also observed in the mammary parenchyma; smaller anechoic areas were also seen in there, which may correspond to lactiferous ducts or smaller vessels (Figs III.19-III.21).

Finally, other tissues (e.g., abdominal muscles or skin) could also be imaged.

Figure III.19. Ultrasonographic view of two mammary glands (left: Rc1, right: Rc3) of a clinically healthy Beagle-breed female dog, on D14 of the *puerperium*. Longitudinal images of mammary parenchyma (mp) with medium echogenicity, compared to that of the liver (l) (left part of each ultrasonogram). In the right ultrasonogram, two separate lobules of the same gland are imaged. Blood vessels (v) are also imaged; smaller anechoic areas within the mammary parenchyma may be lactiferous ducts. Images taken on a MyLab[®] 30 ultrasonography system with linear transducer 10.0 MHz and scanning depth 50 mm.

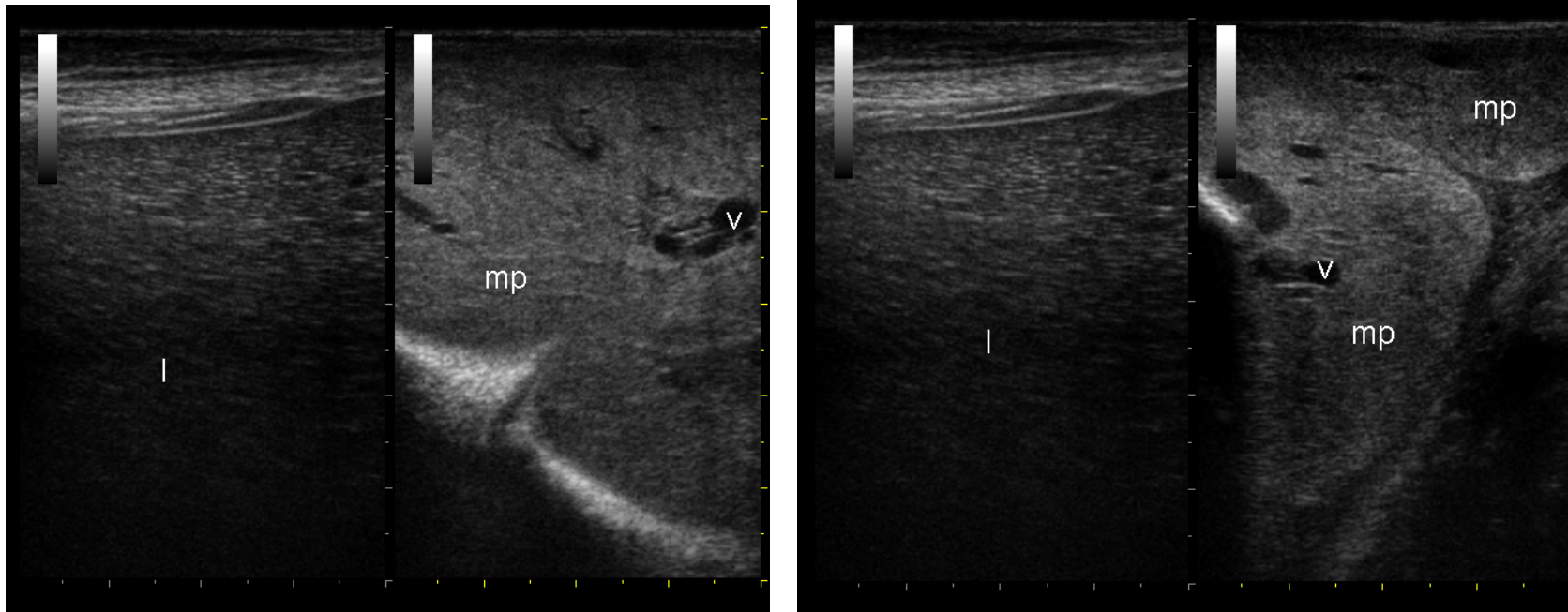

Rc1: the caudal gland in the right side, Rc2 the gland cranially to Rc1, etc.
l: liver, mp: mammary parenchyma, v: vessel.

Figure III.20. Ultrasonographic view of two mammary glands (left: Lc2, right: Rc2) of a clinically healthy Beagle-breed female dog, on D35 of the *puerperium*. Longitudinal images of mammary parenchyma (mp) with medium echogenicity, compared to that of the liver (l) (left part of each ultrasonogram). Blood vessels (v) are also imaged; smaller anechoic areas within the mammary parenchyma may be lactiferous ducts. Connective tissue (ft) separating two lobules is also evident. Images taken on a MyLab[®] 30 ultrasonography system with linear transducer 10.0 MHz and scanning depth 50 mm.

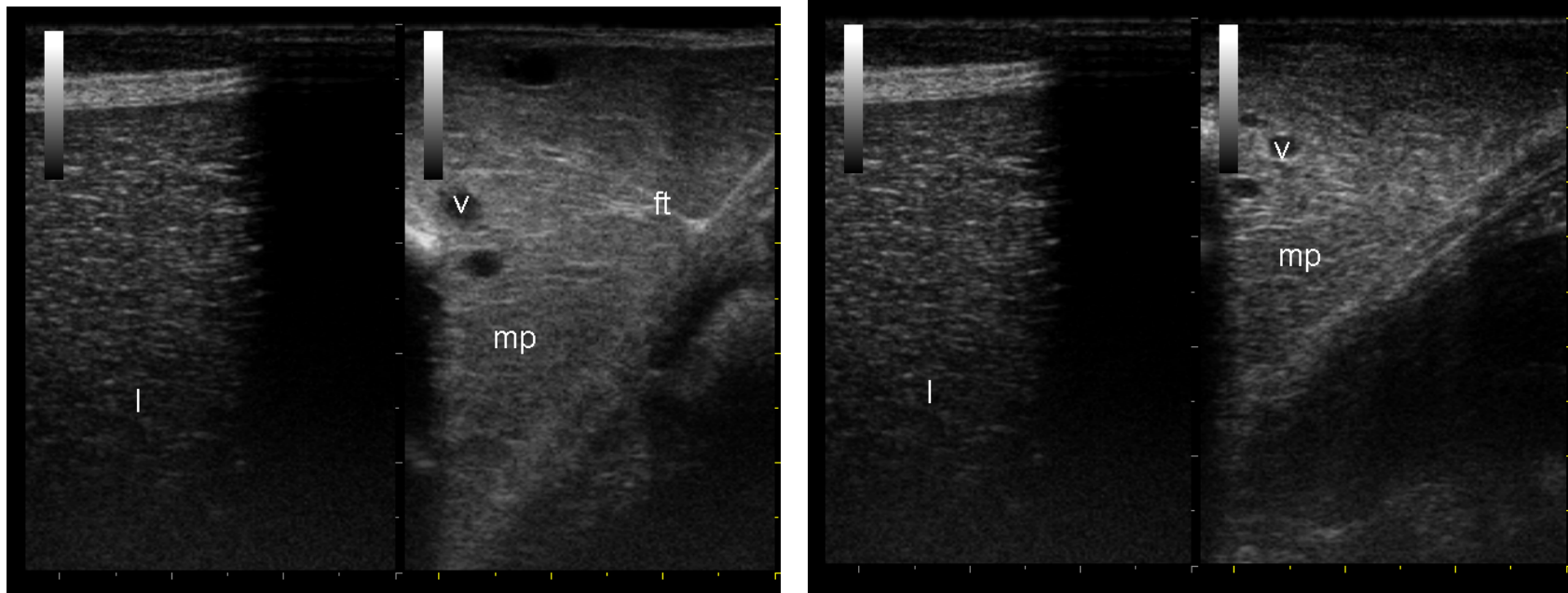

Rc1: the caudal gland in the right side, Rc2 the gland cranially to Rc1, Lc2: the gland contralateral to Rc2.
ft: connective tissue, l: liver, mp: mammary parenchyma, v: vessel.

Figure III.21. Ultrasonographic view of two mammary glands (left: Rc3, right: Rc4) of a clinically healthy Beagle-breed female dog, on D63 of the *puerperium*. Longitudinal images of mammary parenchyma (mp) with medium to low echogenicity, compared to that of the liver (l) (left part of each ultrasonogram). Blood vessels (v) are also imaged. Connective tissue (ft) separating two lobules is also evident. Images taken on a MyLab[®] 30 ultrasonography system with linear transducer 10.0 MHz and scanning depth 50 mm.

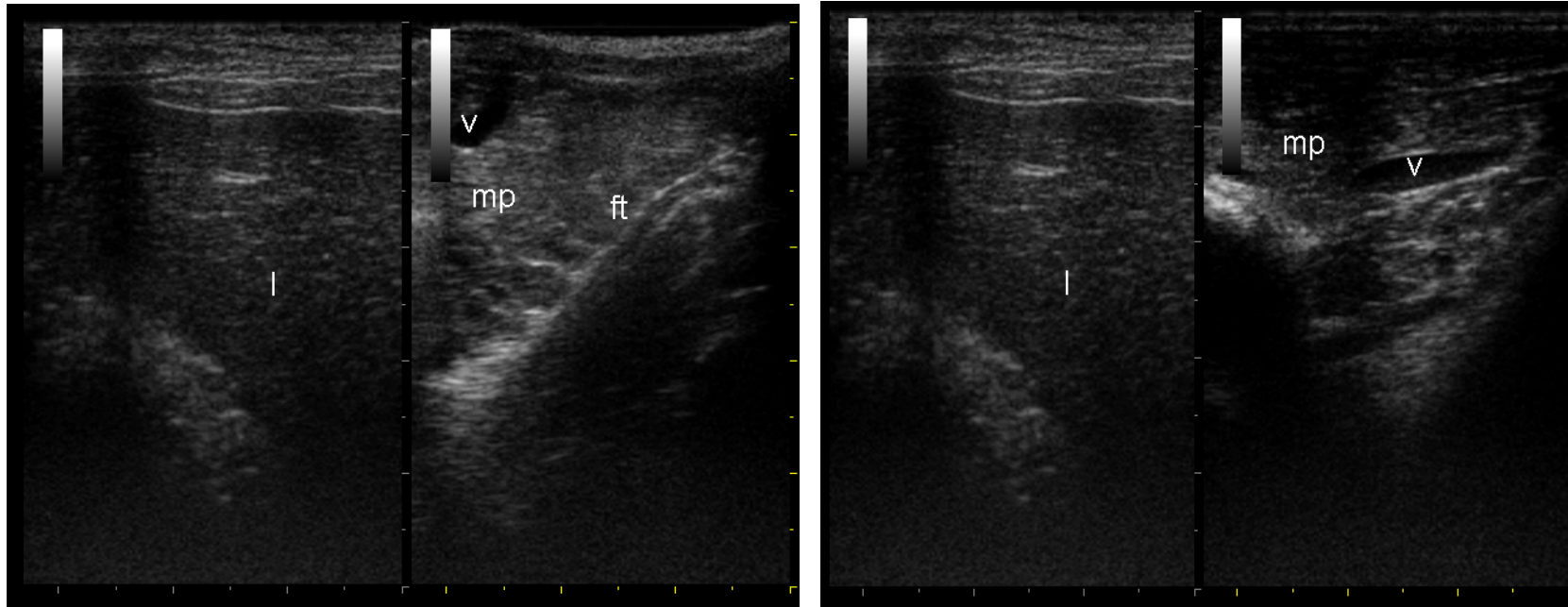

Rc1: the caudal gland in the right side, Rc2 the gland cranially to Rc1, etc.
ft: connective tissue, l: liver, mp: mammary parenchyma, v: vessel.

Bacteriological findings in teat duct material and milk samples

Frequency of bacterial isolation

In total, 244 teat duct material samples and 578 milk samples were examined bacteriologically. Of these, 16 (6.6%) teat duct material samples and 53 (9.2%) milk samples yielded bacteria. Bacteria were isolated from at least one teat duct material sample of each of nine bitches on at least one occasion. Bacteria were isolated from at least one milk sample from each bitch on at least one occasion.

Frequency of bacterial isolation from teat ducts was 0.068 during L1, 0.130 during L2, 0.0 during L3 and 0.028 during L4 ($P=0.072$). Frequency of bacterial isolation from mammary glands was 0.091 during L1, 0.104 during L2, 0.122 during L3 and 0.017 during L4 ($P=0.065$) (Fig. III.22, Table III.xiii).

Risk of infection of mammary glands was 0.125 for Rc1, 0.090 for Rc2, 0.048 for Rc3, 0.019 for Rc4 and 0.071 for Lc1; risk of infection of [Rc1+Rc2] was 0.107, whilst that of [Rc3+Rc4] was 0.033. The probability of bacterial isolation from Rc1 and Rc2, from Rc2 and Rc3 and from Rc3 and Rc4 glands was not significantly different from each other ($P>0.4$, $P=0.121$ and $P=0.4$, respectively) (Figs III.22 and III.23). However, there was a greater probability of bacterial isolation from Rc1 than [Rc3 or Rc4] glands, as well as from Rc2 than Rc4 glands ($P<0.02$). There was also a significantly greater probability of bacterial isolation from [Rc1+Rc2] than from [Rc3+Rc4] glands ($P<0.001$). The probability of bacterial isolation from Rc2 and Lc2 glands was not significantly different from each other ($P=0.86$) (Fig. III.24). The probability of bacterial isolation from Rc2/Lc2 gland and the respective teat duct Rd2/Ld2 was not significantly different ($P>0.5$) (Table III.xiv). Simultaneous bacterial isolation from at least two mammary glands of the same bitch was recorded on 11 occasions.

Time to first infection after whelping was significantly ($P=0.044$) earlier for Rc1 than for Rc2, Rc3 or Rc4 (median time: 3 days for Rc1, >7 days for Rc2, Rc3 or Rc4) (Fig. III.22). There was no significant difference in the time to first infection after whelping neither between Rc2 and Lc2 ($P=0.85$) (Fig. III.23), nor between Rd2 and Ld2 ($P=0.74$). Finally, there was no significant difference in the time to first infection after whelping between Rc2/Lc2 gland and the respective teat duct Rd2/Ld2 ($P=0.77$ and $P=0.85$, respectively).

In relation to duration of infection, none of the comparisons performed (between stages of the *puerperium*, between contralateral teat ducts, in-between right-side mammary glands, between contralateral mammary glands, between mammary glands and respective teat ducts) were

statistically significant ($P \geq 0.25$). Estimated median duration of infection (all infections taken into account) was 2.5 days (95% confidence limits: 1-5.5 d). Estimated rate of clearance of infection was 0.176 per animal-day (95% confidence limits: 0.153-0.203).

Of the 51 occasions, when swab samples from the anterior part of the vagina yielded bacteria, in 3 (6%) cases the same microorganism was isolated from a mammary gland of the animal on the same examination day. Of these, in 2 occasions infection was in the Rc1 gland of the animal and in 1 occasion it was in the Rc3 gland.

Figure III.22. Kaplan-Meier analysis plot showing the estimated probability of four right-side mammary glands of clinically healthy Beagle-breed female dogs remaining uninfected during the *puerperium*.

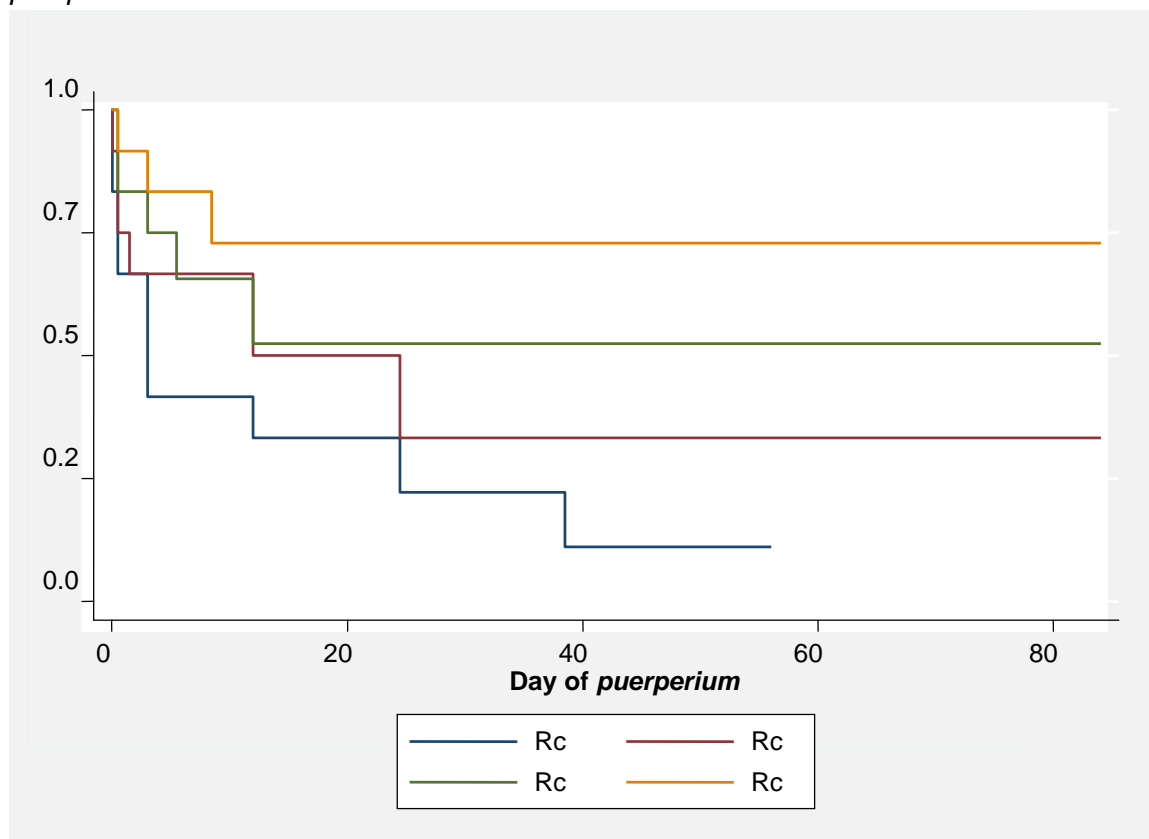

Rc1: the caudal gland in the right side, Rc2 the gland cranially to Rc1, etc.

Figure III.23. Kaplan-Meier analysis plot showing the overall summary of the estimated probability of all mammary glands of clinically healthy Beagle-breed female dogs remaining uninfected during the *puerperium*.

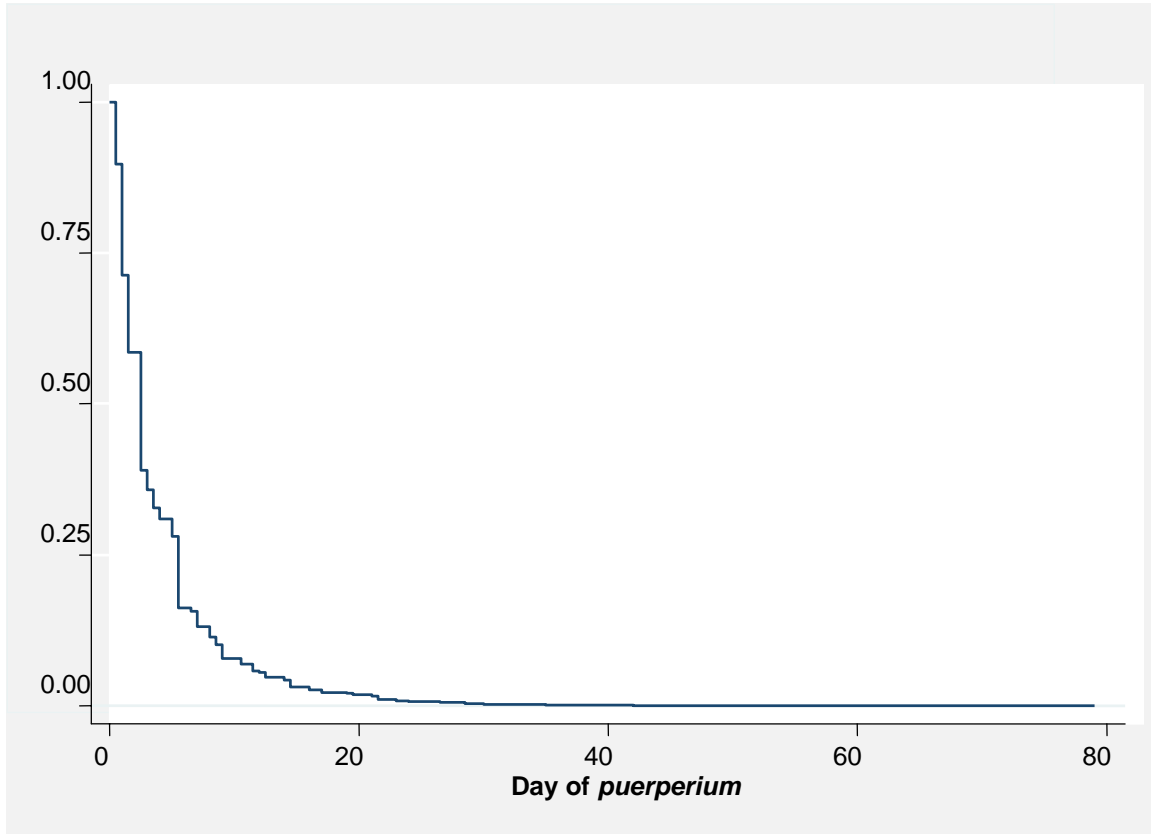
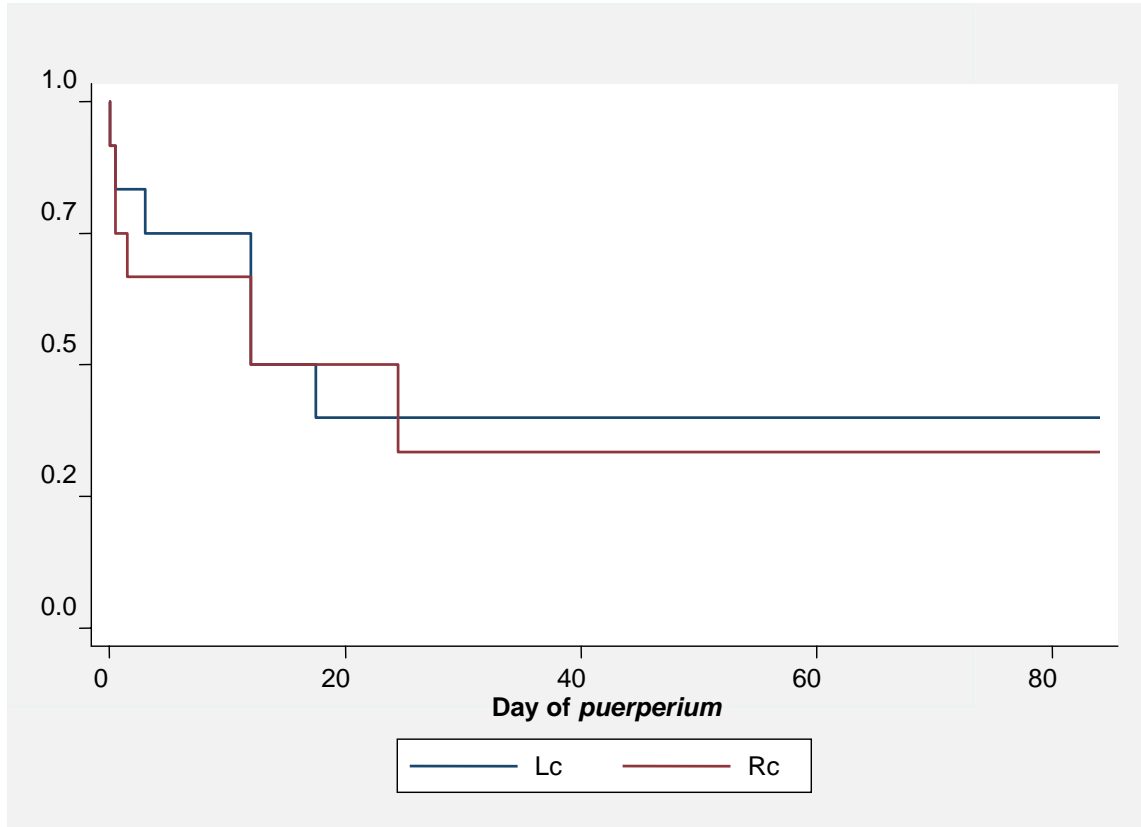

Figure III.24. Kaplan-Meier analysis plot showing the estimated probability of two contralateral mammary glands of clinically healthy Beagle-breed female dogs remaining uninfected during the *puerperium*.



Rc2: the gland in the right side, cranially to the caudal gland, Lc2: the gland contralateral to Rc2.

Table III.xiii. Results of bacteriological examination of milk samples and teat duct material samples from clinically healthy Beagle-breed female dogs, during the *puerperium*.

<i>Puerperium</i> stage	Teat duct material samples		Milk samples	
	Bacteriologically positive samples	Bacteriologically positive dogs ¹	Bacteriologically positive samples	Bacteriologically positive dogs ¹
L1	8/118	5/12	27/295	11/12
L2	7/54	4/10	14/135	6/10
L3	0/36	0/7	11/90	4/7
L4	1/36	¼	1/58	1/4
Total	16/244	9/12	53/578	12/12

L1: D0 (day of whelping)-D7 (7th day after whelping), L2: D8-D21, L3: D22-D42, L4: D43-D84.

1. Bacteriologically positive dog: a dog from which a microorganism was isolated from at least one mammary gland on at least one occasion during the reference period.

Table III.xiv. Results of bacteriological examination of teat duct material samples and milk samples from mammary glands of clinically healthy Beagle-breed female dogs, during the *puerperium*.

Teat duct material samples		
Teat duct	Bacteriologically positive samples	Bacteriologically positive dogs
Rd2	13/122	8/12
Ld2	3/122	3/12
Total	16/244	9/12
Milk samples		
Mammary gland	Bacteriologically positive samples	Bacteriologically positive dogs
Rc1	17/120	10/12
Rc2	14/115	8/12
Rc3	6/114	5/12
Rc4	3/113	3/12
Lc2	13/116	7/12
Rc1+Rc2	31/235	12/12
Rc3+Rc4	9/227	5/12
Total	53/578	12/12

Rc1: the caudal gland in the right side, Rc2 the gland cranially to Rc1, etc.; Lc2: the gland contralateral to Rc2; Rd2: a teat duct in Rc2 mammary gland; Ld2: a teat duct in Lc2 mammary gland.

Bacteriologically positive dog: a dog from which a microorganism was isolated from at least one mammary gland on at least one occasion during the study.

Bacterial identity

From teat duct material samples, bacteria were isolated in pure culture on 15 occasions and in mixed culture on one occasion. From milk samples, bacteria were always isolated in pure culture. Most of the organisms recovered were staphylococci: 14 of the 17 isolates (82%) recovered from teat duct material samples and 45 of the 53 isolates (85%) recovered from milk samples. *Staphylococcus pseudintermedius* was the most frequently recovered species (Table III.xv). On six occasions, bacteria were recovered from milk sample and the respective teat duct material sample on the same sampling occasion; same bacteria were recovered from the two samples of the same animal on all these occasions.

Persistent bacterial isolation from teat ducts was recorded in two incidents (2 dogs); one case involved *S. pseudintermedius* and the other involved *S. xylosus*. Persistent bacterial isolation from mammary glands was recorded in eight incidents (5 dogs); seven cases involved *S. pseudintermedius* and one case involved *S. cohnii*.

Table III.xv. Frequency of isolation of bacteria from teat duct material samples and milk samples from clinically healthy Beagle-breed female dogs, during the *puerperium*.

Bacterial identity	Teat duct material samples	Milk samples
<i>Bacillus</i> spp.	2	5
<i>Escherichia coli</i>	1	0
<i>Pasteurella multocida</i>	0	1
<i>Staphylococcus chromogenes</i>	2	2
<i>Staphylococcus cohnii</i>	1	4
<i>Staphylococcus epidermidis</i>	2	6
<i>Staphylococcus pseudintermedius</i>	7	24
<i>Staphylococcus simulans</i>	0	7
<i>Staphylococcus xylosum</i>	2	1
<i>Staphylococcus</i> sp. coagulase-negative	0	1
<i>Streptococcus canis</i>	0	1
<i>Streptococcus</i> sp.	0	1
Total	17	53

Cytological findings in milk samples

In total, 483 milk samples were examined by using the Whiteside test (WST). Mean (\pm standard error of the mean) WST score of bacteriologically negative samples ($n=442$) was 1.78 ± 0.08 and that of bacteriologically positive samples ($n=41$) was 2.20 ± 0.29 ($P=0.003$). Respective median scores were 2.0 (i.e., '1+') and 2.5 (i.e., between '1+' and '2+'). Details are in Table III.xvi.

There was a significant association between increased WST scores and bacteriologically positive results in milk samples. Overall sensitivity of the test was 74% for 'high' (i.e., $\geq 1+$) WST scores to identifying bacterial infection in milk samples, whilst overall specificity of the test was 53% for 'low' (i.e., $\leq \pm$) WST scores to identifying lack of bacterial infection in milk samples. An even stronger association ($P<0.2$) was recorded between 'low' (i.e., $< 1+$) WST scores and bacteriological findings in only bacteriologically-negative samples. Same findings were observed in only bacteriologically-positive samples: sensitivity was 86% and specificity 65%.

Mean (median) WST scores of samples collected during each *puerperium* stage were as follows: 1.73 (2.0; i.e., '1+') in L1, 1.68 (2.0; i.e., '1+') in L2, 1.58 (2.0; i.e., '1+') in L3 and 3.12 (4.0; i.e., '3+') in L4. There was strong evidence that scores in samples collected during stage L4 were significantly ($P<0.001$) greater than scores in samples collected during the other three stages (which were not significantly different from each other, $P>0.4$) (Fig. III.25). Details are in Table III.xvi.

In L1, the majority of cells observed in milk films were macrophages (70-75%), although lymphocytes (20-25%) and neutrophils (<2%) were also observed. Thereafter (L2, L3, L4), macrophages still constituted the majority of cells, but at lower proportion (50-55%), whilst proportions of lymphocytes and neutrophils increased (45-50% and 2-5%, respectively) (Figs III.26-III.28).

Mean (median) WST scores of samples collected from each of the five mammary glands studied were as follows: 2.46 (3.0; i.e., '2+') for Rc1 gland, 1.71 (2.0; i.e., '1+') for Rc2 gland, 1.68 (2.0; i.e., '1+') for Rc3 gland, 1.85 (2.0; i.e., '1+') for Rc4 gland and 1.48 (2.0; i.e., '1+') for Lc2 gland. There was strong evidence that scores in samples collected from Rc1 gland were significantly ($P<0.015$) greater than scores in samples from the other mammary glands (which were not significantly different from each other, $P>0.13$) (Fig. III.29).

In 16 mammary glands (23 examination occasions), transient bacterial infection and increased WST scores was simultaneously recorded; median duration of such infections was 5.5 days (range: 1-26.5 days). Abnormal mammary features were never seen clinically.

Figure III.25. Boxplot of Whiteside test score values according to *puerperium* stage, during which milk samples were collected from clinically healthy Beagle-breed female dogs.

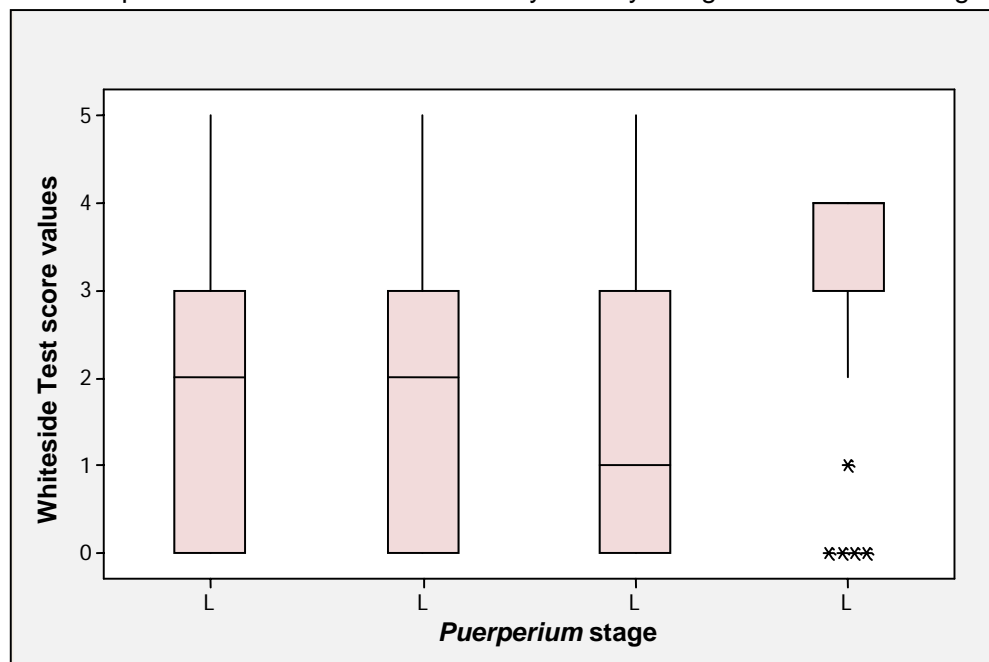

L1: D0 (day of whelping)-D7 (7th day after whelping), L2: D8-D21, L3: D22-D42, L4: D43-D84.

Numerical values correspond to WST scores as follows: value 0 = score '-', value 1 = score '±', value 2 = score '1+', value 3 = score '2+', value 4 = score '3+', value 5 = score '4+'.

Figure III.26. Smear of milk sample, with no leucocytes, from a clinically healthy Beagle-breed female dog, on D2 of the *puerperium* (Giemsa, 100× objective, photograph taken on a Zeiss-Axiostar Microscope).

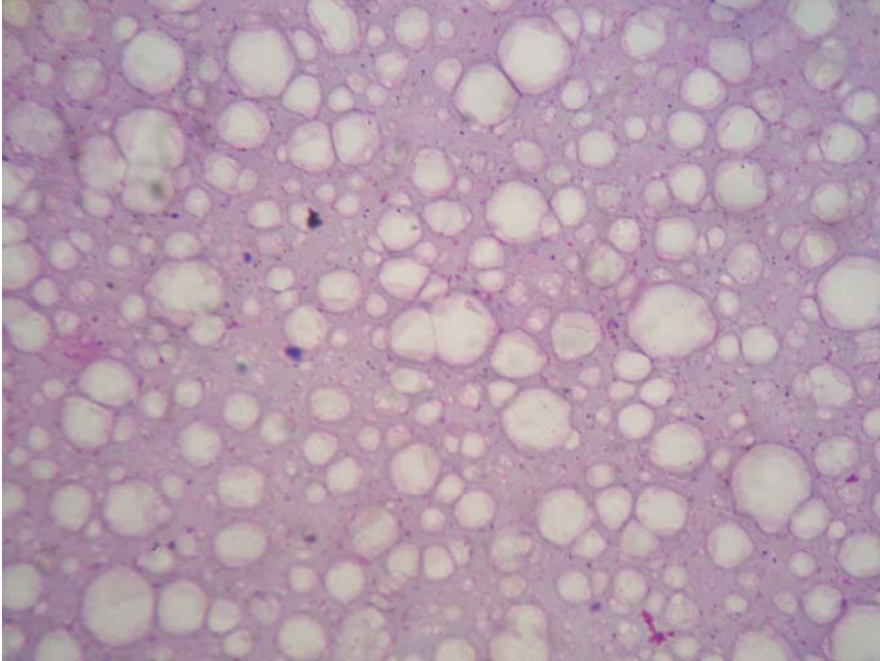

Figure III.27. Macrophages in a smear of milk sample from a clinically healthy Beagle-breed female dog, on D56 of the *puerperium* (Giemsa, 100× objective, photograph taken on a Zeiss-Axiostar Microscope).

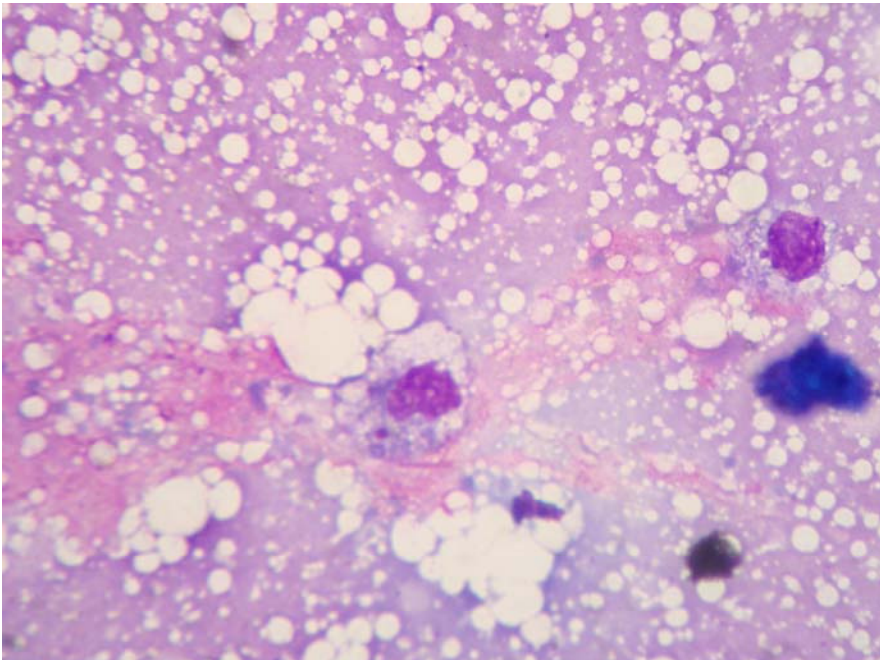

Figure III.28. Neutrophils in a smear of milk sample from a clinically healthy Beagle-breed female dog, on D70 of the *puerperium* (Giemsa, 100× objective, photograph taken on a Zeiss-Axiostar Microscope).

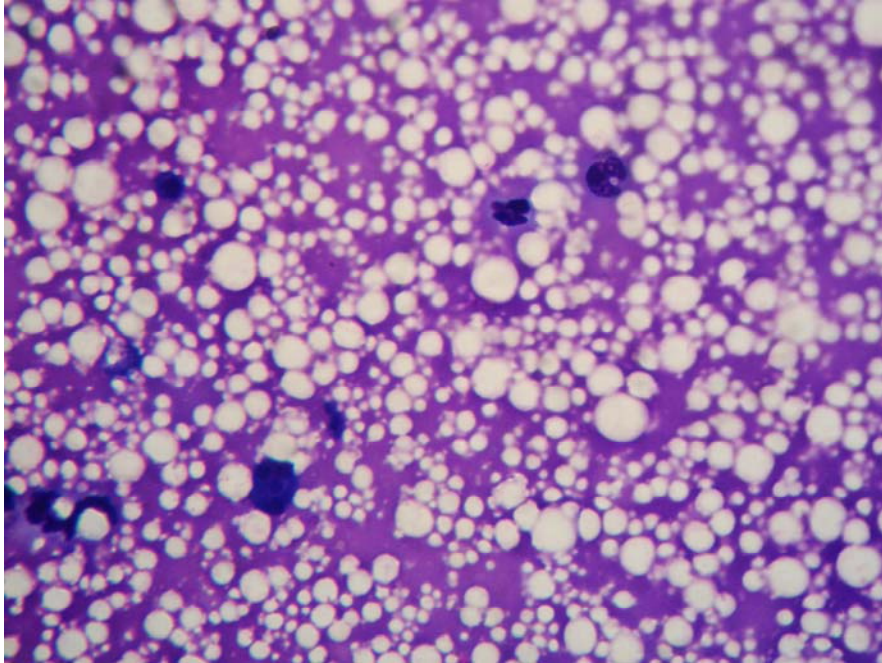
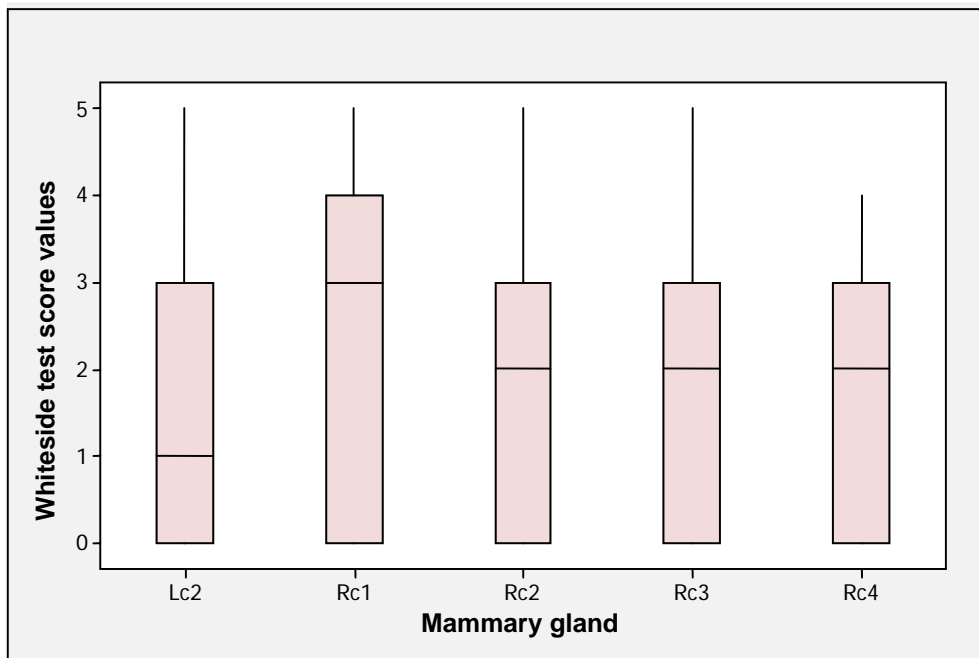

Figure III.29. Boxplot of Whiteside test score values according to mammary glands, from which milk samples were collected from clinically healthy Beagle-breed female dogs.



Rc1: the caudal gland in the right side, Rc2 the gland cranially to Rc1, etc.; Lc2: the gland contralateral to Rc2.

Numerical values correspond to WST scores as follows: value 0 = score '-', value 1 = score '±', value 2 = score '1+', value 3 = score '2+', value 4 = score '3+', value 5 = score '4+'.

Table III.xvi. Results (mean±standard error of the mean) of Whiteside test scores in milk samples from clinically healthy Beagle-breed female dogs, during the *puerperium*.

<i>Puerperium</i> stage	Mammary gland					All samples
	Rc1	Rc2	Rc3	Rc4	Lc2	
L1	2.26±0.28	1.68±0.22	1.71±0.22	1.73±0.24	1.37±0.21	1.73±0.11
L2	3.05±0.18	1.32±0.25	1.49±0.29	1.68±0.33	1.08±0.27	1.68±0.14
L3	2.07±0.49	1.41±0.40	1.59±0.40	1.60±0.41	1.29±0.31	1.58±0.17
L4	2.67±0.55	3.18±0.35	2.83±0.48	3.82±0.17	3.18±0.38	3.12±0.19 ^a
All samples	2.46±0.18 ^a	1.71±0.15	1.68±0.16	1.85±0.17	1.48±0.15	

L1: D0 (day of whelping)-D7 (7th day after whelping), L2: D8-D21, L3: D22-D42, L4: D43-D84.

Rc1: the caudal gland in the right side, Rc2 the gland cranially to Rc1, etc.; Lc2: the gland contralateral to Rc2.

Numerical values correspond to WST scores as follows: value 0 = score '-', value 1 = score '±', value 2 = score '1+', value 3 = score '2+', value 4 = score '3+', value 5 = score '4+'.

a: $P < 0.05$ compared to findings in other mammary glands or in other stages of the *puerperium*.

Behavioural findings

Bitch behaviour

As the *puerperium* advanced, there was a significant progressive increase in mobility of the animals ('Inside whelping box': frequency $P < 0.001$, duration $P = 0.001$; 'Outside whelping box': frequency $P < 0.001$, duration $P < 0.001$). There was also a significant progressive decrease of interaction with puppies ('Grooming puppy': frequency $P < 0.001$, duration $P < 0.001$; 'Contact with puppies': frequency $P < 0.001$, duration $P < 0.001$). On three occasions for frequency ('Inside whelping box' in L2 and L4, 'Outside whelping box' in L4) and on four occasions for duration ('Lying in contact' in L2, L3 and L4, 'Vocalisation' in L4), there were significant differences in behaviours of bitches with large and bitches with small litters. Detailed results of the behaviours observed in the bitches are in Tables III.xvii and III.xviii.

Puppy behaviour

Puppies were observed to stand up for the first time on the 21st day of life (median value; range: 17-24th day). There was a significant increase in mobility of the animals during the 4th stage of the *puerperium* ('Inside whelping box': frequency $P < 0.001$, duration $P = 0.001$; 'Outside whelping box': frequency $P < 0.001$, duration $P < 0.001$). There was also a significant progressive increase in their activity ('Lie down': frequency $P < 0.001$, duration $P < 0.001$; 'Playing'; frequency $P < 0.001$,

duration $P<0.001$), although within L4 'Playing' behaviour was reduced subsequently to 63rd day of life.

Sucking behaviours decreased progressively as the *puerperium* advanced ('Successful suck': frequency $P=0.085$, duration $P<0.001$; 'Sucking bout'; frequency $P=0.072$, duration $P<0.001$) (Figs III.30 and III.31). On three occasions for duration of the behaviours ('Inside whelping box' in L3, 'Outside whelping box' in L3 and 'Playing' in L4), there were significant differences between behaviours of puppies in large and puppies in small litters. Detailed results of the behaviours observed in the puppies are in Tables III.xix and III.xx.

There was no significant difference in the frequency of successful sucks of puppies between the right (median: 2.0 events, range: 0-11) and the left (median: 1.5 events, range: 0-9) mammary glands ($P=0.973$); results were also not significant for puppies in small ($P=0.531$) or large ($P=0.613$) litters. However, there was a significant difference in the frequency of successful sucks of puppies between the more caudal (i.e., [c1+c2]) (median: 1.0 events, range: 0-6) and the more cranial (i.e., [c3+c4+c5]) (median: 0.0 events, range: 0-5) mammary glands ($P<0.001$); results were also significant for puppies in small or in large litters ($P<0.001$). Detailed results of frequency of 'Successful sucks' of puppies in relation to the mammary gland of their dams are in Table III.xxi.

Finally, Table III.xxii presents the frequency of 'Successful sucks' of puppies in relation to mammary gland of their dam and their potential association with risk of infection of the respective mammary gland. Tendency lines drawn for frequency of 'Successful sucks' of puppies and risk of infection for five mammary glands (Rc1, Rc2, Rc3, Rc4 and Lc2) and two teat ducts (Rd2, Ld2) of their dams were associated throughout the study (Fig. III.32).

Fig. III.30. Frequency of 'Successful suck' of puppies of clinically healthy Beagle-breed female dogs during their daily observation period throughout the *puerperium* (black straight line: puppies in small litters, black dotted line: puppies in large litters, respective red lines: tendency lines for above).

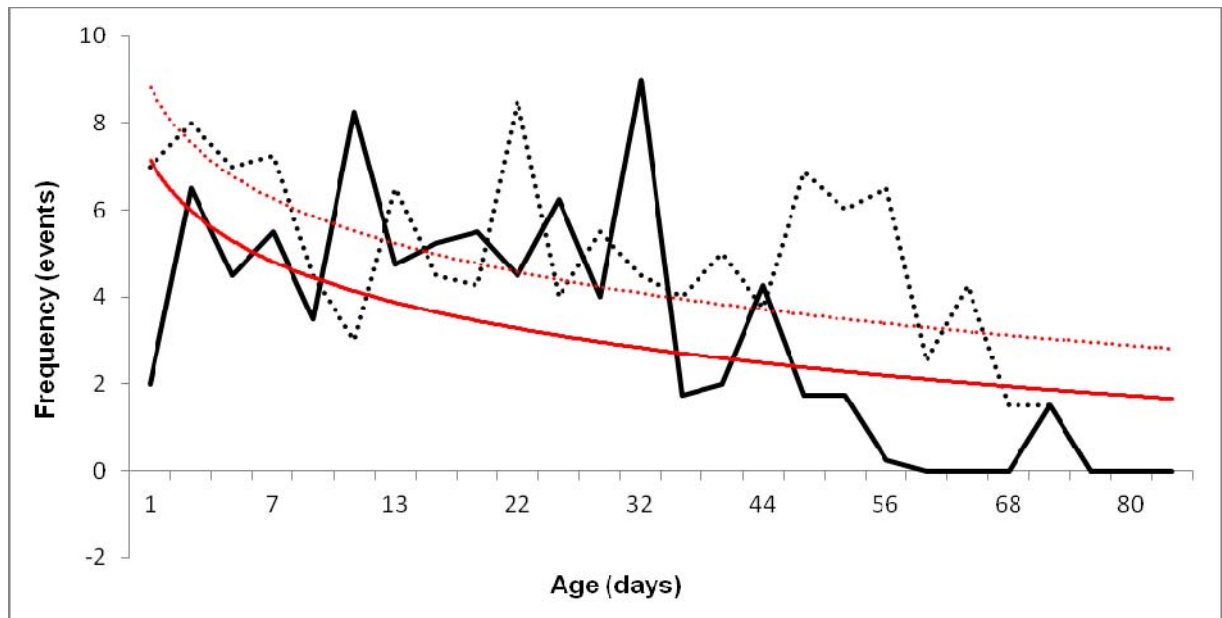

Fig. III.31. Frequency of 'Sucking bout' of puppies of clinically healthy Beagle-breed female dogs during their daily observation period throughout the *puerperium* (black straight line: puppies in small litters, black dotted line: puppies in large litters, respective red lines: tendency lines for above).

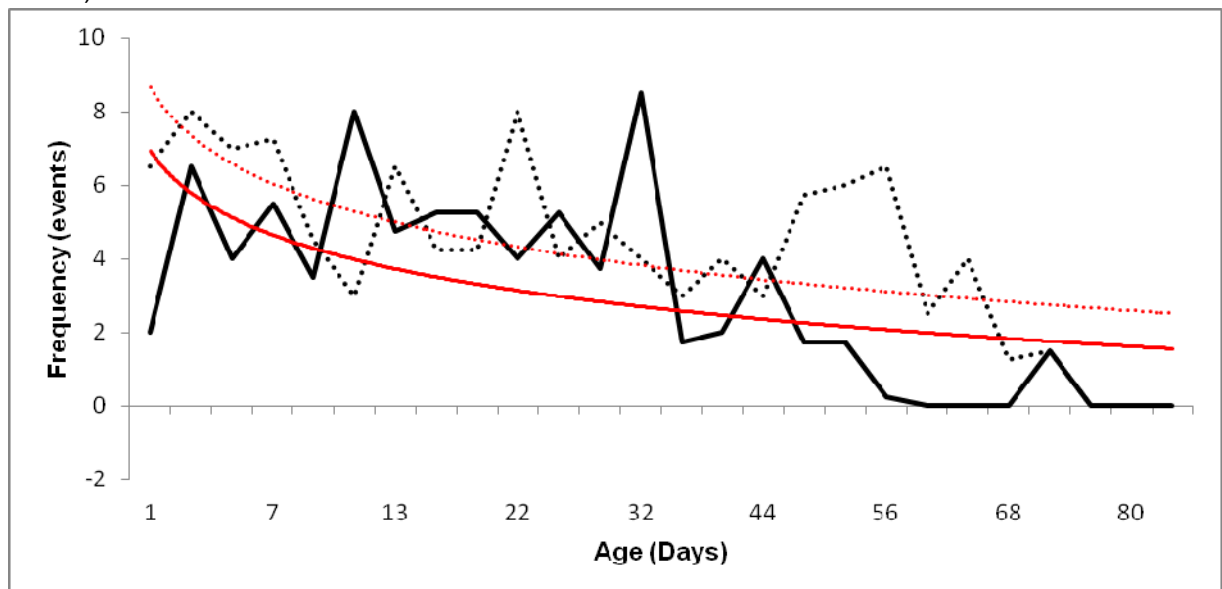
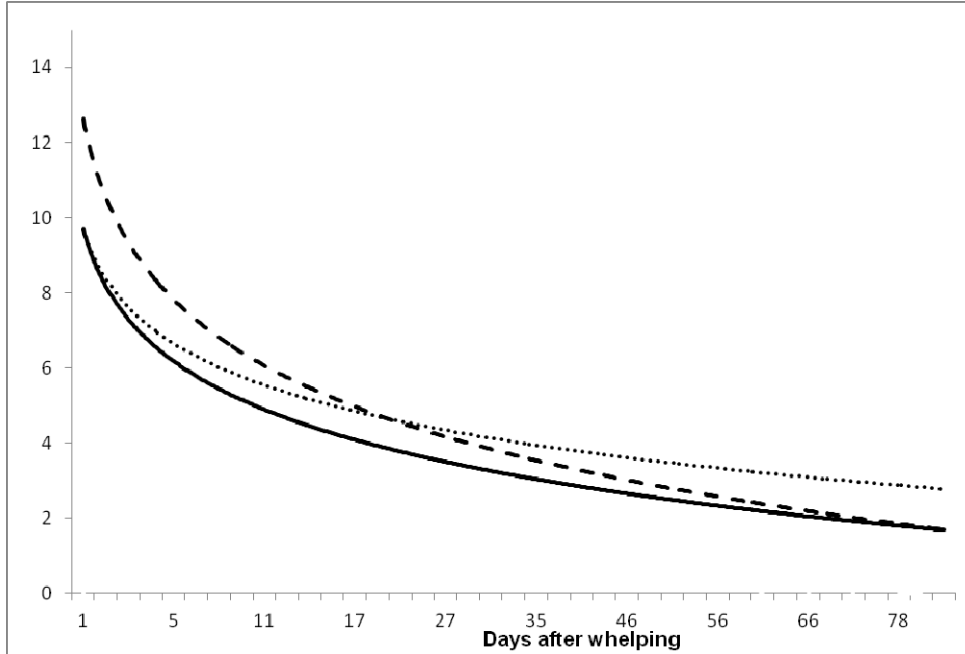

Fig. III.32. Tendency lines of frequency of ‘Successful sucks’ of puppies of clinically healthy Beagle-breed female dogs during their daily observation period throughout the *puerperium* (straight line) and risk of infection for five mammary glands (Rc1, Rc2, Rc3, Rc4 and Lc2) (interrupted line) and two teat ducts (Rd2, Ld2) (dotted line) of their dams throughout the *puerperium*.



Vertical axis: Frequency (events) of ‘Successful sucks’ of puppies / Risk of infection (%) of mammary glands and teat ducts.

Table III.xvii. Median (range) frequency (events) of behaviours of clinically healthy Beagle-breed female dogs during their daily observation period throughout the *puerperium*.

Behaviour	<i>Puerperium</i> stage				<i>P</i> values*
	L1	L2	L3	L4	
All bitches					
Butting	1.0 (0-6)	0.0 (0-2)	0.0 (0-0)	0.0 (0-0)	0.096
Lying away from puppies	0.0 (0-7)	0.0 (0-5)	0.0 (0-13)	0.0 (0-14)	0.621
Lying in contact with puppies	20.5 (3-54)	11.5 (0-31)	7.0 (0-23)	3.0 (1-17)	<0.001
Grooming herself	2.0 (0-8)	1.0 (0-7)	1.0 (0-9)	0.0 (0-9)	0.146
Grooming puppy	17.0 (3-48)	10.0 (3-37)	2.0 (0-18)	2.0 (0-13)	<0.001
Inside whelping box	5.0 (2-22)	5.0 ^a (1-32)	10.5 (0-49)	18.5 (1-83)	<0.001
Outside whelping box	4.0 (1-21)	6.0 (1-33)	9.0 (1-49)	15.0 (0-82)	<0.001
Playing	0.0 (0-0)	0.0 (0-0)	0.0 (0-3)	0.0 (0-14)	0.005
Protecting puppies	0.0 (0-2)	0.0 (0-4)	0.0 (0-0)	0.0 (0-0)	0.155
Vocalizations	0.0 (0-29)	0.0 (0-9)	0.0 (0-2)	0.0 (0-10)	0.153
Bitches with large litters					
Butting	1.0 (0-6)	0.0 (0-2)	0.0 (0-0)	0.0 (0-0)	0.619
Lying away from puppies	0.0 (0-5)	0.0 (0-5)	0.5 (0-13)	0.0 (0-14)	0.370
Lying in contact with puppies	19.0 (3-54)	12.0 (0-31)	7.0 (0-11)	2.5 (1-17)	0.008
Grooming herself	2.5 (0-8)	1.0 (0-5)	1.5 (0-9)	0.0 (0-9)	0.504
Grooming puppy	17.0 (3-48)	10.5 (3-37)	1.5 (0-13)	1.5 (0-11)	<0.001
Inside whelping box	5.0 (2-22)	5.0 ^a (1-32)	10.5 (0-49)	18.5 ^a (1-83)	0.001
Outside whelping box	5.0 (1-21)	4.5 (1-33)	10.5 (1-49)	17.5 ^a (0-82)	0.001
Playing	0.0 (0-0)	0.0 (0-0)	0.0 (0-3)	0.0 (0-8)	0.019
Protecting puppies	0.0 (0-2)	0.0 (0-1)	0.0 (0-0)	0.0 (0-0)	0.607
Vocalizations	0.0 (0-29)	0.0 (0-1)	0.0 (0-2)	0.0 (0-9)	0.532

Table continued on next page.

Table III.xvii. Median (range) frequency (events) of behaviours of clinically healthy Beagle-breed female dogs during their daily observation period throughout the *puerperium* (continued).

Behaviour	<i>Puerperium</i> stage				<i>P</i> values *
	L1	L2	L3	L4	
Bitches with small litters					
Butting	1.0 (0-6)	0.0 (0-2)	0.0 (0-0)	0.0 (0-0)	0.132
Lying away from puppies	0.0 (0-7)	0.0 (0-4)	0.0 (0-3)	0.0 (0-4)	0.821
Lying in contact with puppies	21.0 (6-54)	10.0 (1-29)	7.0 (2-23)	3.0 (1-12)	0.013
Grooming herself	1.5 (0-4)	1.0 (0-7)	1.0 (0-4)	0.0 (0-4)	0.189
Grooming puppy	17.0 (5-48)	10.0 (0-19)	3.0 (0-18)	3.0 (0-13)	0.005
Inside whelping box	4.5 (2-22)	9.0 ^a (3-18)	8.0 (3-13)	11.0 ^a (6-33)	0.002
Outside whelping box	4.0 (1-21)	7.0 (3-18)	8.0 (3-14)	12.0 ^a (5-37)	0.001
Playing	0.0 (0-0)	0.0 (0-0)	0.0 (0-3)	0.0 (0-14)	0.067
Protecting puppies	0.0 (0-2)	0.0 (0-4)	0.0 (0-0)	0.0 (0-0)	0.450
Vocalizations	0.0 (0-12)	0.0 (0-9)	0.0 (0-1)	1.0 (0-10)	0.199

L1: D0 (day of whelping)-D7 (7th day after whelping), L2: D8-D21, L3: D22-D42, L4: D43-D84.

Large litters: litters with 7-9 puppies, small litters: litters with 4-5 puppies.

* *P* values refer to comparison between the four stages through time.

a: differences between values observed in bitches with large or small litters found significant ($P < 0.05$).

Table III.xviii. Median (range) duration (minutes) of behaviours of clinically healthy Beagle-breed female dogs during their daily observation period throughout the *puerperium*.

Behaviour	<i>Puerperium</i> stage				<i>P</i> values*
	L1	L2	L3	L4	
All bitches					
Butting	0.00 (0.00-9.75)	0.00 (0.00-1.67)	0.00 (0.00-0.00)	0.00 (0.00-0.00)	0.975
Lying away from puppies	0.00 (0.00-71.00)	0.00 (0.0-139.50)	2.10 (0.0-116.75)	0.00 (0.00-91.83)	<0.001
Lying in contact with puppies	101.10 (37.75-143.00)	63.00 (0.83-113.08)	72.30 (0.00-111.67)	46.05 (1.25-127.92)	<0.001
Grooming herself	0.60 (0.00-10.08)	0.15 (0.00-3.58)	0.45 (0.00-5.50)	0.00 (0.00-6.75)	0.762
Grooming puppy	13.65 (1.17-48.5)	7.95 (0.00-29.83)	1.05 (0.00-8.42)	0.75 (0.00-10.00)	<0.001
Inside whelping box	139.20 (69.58-150.00)	112.65 (6.33-150.00)	67.15 (0.00-143.25)	127.50 (30.83-150.00)	0.001
Outside whelping box	10.80 (1.08-80.42)	45.00 (0.00-143.7)	73.33 (6.75-150.0)	22.50 (0.00-119.17)	<0.001
Playing	0.00 (0.00-0.00)	0.00 (0.00-0.00)	0.00 (0.00-3.75)	0.00 (0.00-11.42)	0.024
Protecting puppies	0.00 (0.00-3.58)	0.00 (0.00-6.08)	0.00 (0.00-0.00)	0.00 (0.00-0.00)	0.282
Vocalizations	0.00 (0.00-6.00)	0.00 (0.00-2.00)	0.00 (0.00-2.50)	0.45 (0.00-11.83)	<0.001
Bitches with large litters					
Butting	0.00 (0.00-0.92)	0.00 (0.00-0.33)	0.00 (0.00-0.00)	0.00 (0.00-0.00)	0.682
Lying away from puppies	0.00 (0.00-71.00)	0.00 (0.0-139.50)	4.08 (0.0-116.00)	0.00 (0.00-53.42)	0.863
Lying in contact with puppies	100.58 (48.67-133.17)	78.33 ^a (6.67-101.33)	68.83 ^a (0.00-111.67)	51.08 ^a (6.58-117.25)	0.065
Grooming herself	0.75 (0.00-10.08)	0.33 (0.00-3.58)	0.50 (0.00-5.50)	0.00 (0.00-6.75)	0.813
Grooming puppy	16.50 (1.17-48.5)	10.08 (0.42-23.16)	1.00 (0.00-8.42)	0.33 (0.00-10.00)	0.004
Inside whelping box	138.25 (69.58-148.92)	136.92 (6.33-148.42)	65.75 (0.00-143.25)	131.67 (96.17-150.00)	0.365
Outside whelping box	11.75 (1.08-80.42)	13.08 (1.58-143.7)	84.25 (6.75-150.0)	18.33 (0.00-68.83)	0.120
Playing	0.00 (0.00-0.00)	0.00 (0.00-0.00)	0.00 (0.00-0.75)	0.00 (0.00-3.33)	0.008
Protecting puppies	0.00 (0.00-3.58)	0.00 (0.00-1.42)	0.00 (0.00-0.00)	0.00 (0.00-0.00)	0.973
Vocalizations	0.00 (0.00-3.42)	0.00 (0.00-0.25)	0.00 (0.00-0.75)	0.17 ^a (0.00-2.08)	0.022

Table continued on next page.

Table III.xviii. Median (range) duration (minutes) of behaviours of clinically healthy Beagle-breed female dogs during their daily observation period throughout the *puerperium* (continued).

Behaviour	<i>Puerperium</i> stage				<i>P</i> values *
	L1	L2	L3	L4	
Bitches with small litters					
Butting	0.17 (0.00-9.75)	0.00 (0.00-1.67)	0.00 (0.00-0.00)	0.00 (0.00-0.00)	0.948
Lying away from puppies	0.00 (0.00-49.83)	0.00 (0.0-108.67)	0.00 (0.0-116.75)	0.00 (0.00-91.83)	0.525
Lying in contact with puppies	98.75 (37.75-143.00)	48.17 ^a (0.83-113.08)	47.33 ^a (8.50-96.50)	31.75 ^a (1.25-127.92)	0.002
Grooming herself	0.42 (0.00-1.75)	0.17 (0.00-2.42)	0.25 (0.00-1.25)	0.00 (0.00-1.00)	0.637
Grooming puppy	10.42 (2.50-48.5)	6.83 (0.00-29.83)	1.92 (0.00-7.42)	1.00 (0.00-6.50)	0.053
Inside whelping box	139.58 (92.83-150.00)	97.08 (32.58-150.00)	87.67 (21.50-135.67)	110.83 (30.83-144.08)	<0.001
Outside whelping box	10.02 (0.00-56.17)	52.92 (0.00-117.42)	62.33 (14.33-128.50)	39.17 (5.92-119.17)	<0.001
Playing	0.00 (0.00-0.00)	0.00 (0.00-0.00)	0.00 (0.00-3.75)	0.00 (0.00-11.42)	0.063
Protecting puppies	0.00 (0.00-0.92)	0.00 (0.00-6.08)	0.00 (0.00-0.00)	0.00 (0.00-0.00)	0.111
Vocalizations	0.00 (0.00-6.0)	0.00 (0.00-2.00)	0.00 (0.00-2.50)	1.25 ^a (0.00-11.83)	<0.001

L1: D0 (day of whelping)-D7 (7th day after whelping), L2: D8-D21, L3: D22-D42, L4: D43-D84.

Large litters: litters with 7-9 puppies, small litters: litters with 4-5 puppies.

* *P* values refer to comparison between the four stages through time.

a: differences between values observed in bitches with large or small litters found significant ($P < 0.05$).

Table III.xix. Median (range) frequency (events) of behaviours of puppies of clinically healthy Beagle-breed female dogs during their daily observation period throughout the *puerperium*.

Behaviour	<i>Puerperium</i> stage				<i>P</i> values*
	L1	L2	L3	L4	
All puppies					
Inside whelping box	1.0 (1-2)	1.0 (1-2)	1.0 (1-4)	7.0 (1-14)	<0.001
Investigates dam	0.2 (0-5)	0.0 (0-1)	0.0 (0-2)	0.0 (0-1)	0.002
Lie down	16.5 (12-33)	12.5 (8-33)	10.0 (5-16)	7.5 (2-15)	<0.001
Outside whelping box	0.0 (0-1)	0.0 (0-1)	0.5 (0-4)	6.5 (0-14)	<0.001
Playing	0.0 (0-0)	0.0 (0-2)	6.0 (0-19)	8.5 (0-26)	<0.001
Searching teat	6.5 (0-13)	5.0 (0-17)	6.5 (0-16)	3.5 (0-16)	0.385
Sucking attempt	0.0 (0-5)	0.5 (0-5)	1.0 (0-4)	0.0 (0-10)	0.061
Successful suck	6.5 (1-16)	4.5 (0-16)	5.0 (0-12)	1.5 (0-13)	0.085
Sucking bout	6.5 (1-14)	4.5 (0-13)	5.0 (0-11)	1.5 (0-6)	0.072
Puppies in large litters					
Inside whelping box	1.0 (1-2)	1.0 (1-2)	1.0 (1-4)	4.5 (1-14)	<0.001
Investigates dam	0.0 (0-5)	0.0 (0-1)	0.0 (0-2)	0.0 (0-1)	0.841
Lie down	16.5 (12-29)	11.5 (8-24)	10.0 (5-16)	9.0 (3-13)	<0.001
Outside whelping box	0.0 (0-1)	0.0 (0-1)	0.5 (0-4)	4.0 (0-14)	<0.001
Playing	0.0 (0-0)	0.0 (0-1)	7.0 (0-19)	7.5 (0-19)	<0.001
Searching teat	7.0 (0-13)	5.0 (0-12)	6.5 (0-16)	4.5 (0-16)	0.740
Sucking attempt	0.0 (0-3)	0.5 (0-5)	1.0 (0-4)	0.0 (0-10)	0.095
Successful suck	7.0 (1-16)	4.5 (0-9)	5.0 (0-12)	2.0 (0-13)	0.617
Sucking bout	7.0 (1-14)	4.5 (0-9)	5.0 (0-10)	2.0 (0-1)	0.571

Table continued on next page.

Table III.xix. Median (range) frequency (events) of behaviours of puppies of clinically healthy Beagle-breed female dogs during their daily observation period throughout the *puerperium* (continued).

Behaviour	<i>Puerperium</i> stage				<i>P</i> values*
	L1	L2	L3	L4	
Puppies in small litters					
Inside whelping box	1.0 (1-1)	1.0 (1-1)	1.0 (1-2)	9.0 (10-14)	<0.001
Investigates dam	0.5 (0-5)	0.0 (0-1)	0.0 (0-1)	0.0 (0-1)	0.080
Lie down	17.0 (11-33)	15.5 (8-33)	11.0 (2-16)	5.5 (2-15)	0.008
Outside whelping box	0.0 (0-0)	0.0 (0-0)	0.0 (0-1)	10.0 (0-13)	<0.001
Playing	0.0 (0-0)	0.0 (0-2)	4.0 (0-12)	11.0 (3-26)	<0.001
Searching teat	5.0 (1-13)	5.0 (2-17)	5.5 (2-12)	2.0 (0-7)	0.711
Sucking attempt	0.0 (0-5)	0.5 (0-3)	0.5 (0-4)	0.5 (0-5)	0.241
Successful suck	5.0 (1-13)	5.5 (1-16)	4.5 (1-11)	0.5 (0-6)	0.372
Sucking bout	5.0 (1-13)	5.0 (1-13)	4.0 (1-11)	0.5 (0-6)	0.388

L1: D0 (day of whelping)-D7 (7th day after whelping), L2: D8-D21, L3: D22-D42, L4: D43-D84.

Large litters: litters with 7-9 puppies, small litters: litters with 4-5 puppies.

* *P* values refer to comparison between the four stages through time.

Table III.xx. Median (range) duration (minutes) of behaviours of puppies of clinically healthy Beagle-breed female dogs during their daily observation period throughout the *puerperium*.

Behaviour	<i>Puerperium</i> stage				<i>P</i> values *
	L1	L2	L3	L4	
All puppies					
Inside whelping box	150.00 (150.0-150.0)	150.00 (150.0-150.0)	134.25 (3.1-150.0)	128.31 (70.7-150.0)	<0.001
Investigates dam	0.39 (0.0-31.4)	0.00 (0.0-1.1)	0.00 (0.0-2.1)	0.00 (0.0-0.3)	0.461
Lie down	101.75 (60.1-139.2)	110.85 (81.4-141.6)	111.70 (60.4-136.9)	77.90 (19.5-138.9)	<0.001
Outside whelping box	0.00 (0.0-0.0)	0.00 (0.0-0.0)	12.15 (0.0-146.9)	22.18 (0.0-79.4)	<0.001
Playing	0.00 (0.0-0.0)	0.00 (0.0-1.8)	5.15 (0.0-18.4)	13.17 (0.00-34.5)	<0.001
Searching teat	2.88 (0.3-15.2)	1.98 (0.0-23.1)	2.02 (0.0-7.6)	0.30 (0.0-2.8)	0.096
Sucking attempt	0.00 (0.0-0.8)	0.06 (0.0-1.3)	0.10 (0.0-0.5)	0.19 (0.0-1.9)	0.141
Successful suck	23.12 (1.2-78.3)	16.75 (0.0-44.9)	12.98 (0.0-38.3)	1.15 (0.0-16.1)	<0.001
Sucking bout	21.75 (1.2-66.2)	17.30 (0.0-45.8)	13.00 (0.09-38.3)	1.25 (0.0-16.1)	<0.001
Puppies in large litters					
Inside whelping box	150.00 (150.0-150.0)	150.00 (150.0-150.0)	150.00 ^a (95.6-150.0)	122.25 (70.7-150.0)	<0.001
Investigates dam	0.45 (0.0-31.4)	0.00 (0.0-1.1)	0.00 (0.0-0.2)	0.00 (0.0-0.3)	0.807
Lie down	105.00 (60.1-139.2)	110.40 (81.4-131.3)	114.45 (60.4-136.9)	62.10 (19.5-105.6)	<0.001)
Outside whelping box	0.00 (0.0-0.0)	0.00 (0.0-0.0)	0.00 ^a (0.0-26.7)	27.90 (0.0-79.4)	<0.001
Playing	0.00 (0.0-0.0)	0.00 (0.0-1.8)	5.25 (0.0-16.2)	15.15 ^a (4.3-34.5)	<0.001
Searching teat	2.08 (0.3-15.2)	1.75 (0.3-23.1)	1.67 (0.3-7.6)	0.25 (0.0-2.5)	0.932
Sucking attempt	0.00 (0.0-0.8)	0.08 (0.0-0.4)	0.08 (0.0-0.3)	0.17 (0.0-1.0)	0.185
Successful suck	20.92 (1.4-66.1)	15.92 (4.4-44.9)	12.75 (1.9-31.8)	0.42 (0.0-13.9)	0.002
Sucking bout	21.00 (2.2-66.2)	16.05 (4.5-45.8)	12.75 (1.9-28.3)	0.45 (0.0-13.9)	0.002

Table continued on next page.

Table III.xx. Median (range) duration (minutes) of behaviours of puppies of clinically healthy Beagle-breed female dogs during their daily observation period throughout the *puerperium* (continued).

Behaviour	<i>Puerperium</i> stage				<i>P</i> values*
	L1	L2	L3	L4	
Puppies in small litters					
Inside whelping box	150.00 (150.0-150.0)	150.00 (150.0-150.0)	117.60 ^a (3.1-150.0)	136.05 (70.6-150.0)	0.002
Investigates dam	0.00 (0.0-4.4)	0.00 (0.0-0.5)	0.00 (0.0-2.1)	0.00 (0.0-0.3)	0.732
Lie down	92.85 (69.6-139.2)	112.20 (81.4-141.6)	103.20 (72.1-120.0)	82.65 (19.5-138.9)	0.084
Outside whelping box	0.00 (0.0-0.0)	0.00 (0.0-0.0)	34.50 ^a (0.0-146.9)	13.95 (0.0-79.3)	0.002
Playing	0.00 (0.0-0.0)	0.00 (0.0-1.4)	4.95 (0.0-18.4)	9.00 ^a (0.0-27.6)	<0.001
Searching teat	4.17 (0.3-9.2)	2.50 (0.0-6.5)	2.83 (0.0-5.7)	0.50 (0.0-2.8)	0.342
Sucking attempt	0.00 (0.0-0.3)	0.00 (0.0-1.3)	0.17 (0.0-0.5)	0.25 (0.0-1.9)	0.135
Successful suck	31.58 (1.2-78.3)	19.16 (0.0-9.2)	13.75 (0.0-38.3)	3.08 (0.0-16.1)	0.070
Sucking bout	23.85 (1.2-57.9)	19.20 (0.0-45.7)	13.60 (0.0-38.3)	3.90 (0.0-16.1)	0.079

L1: D0 (day of whelping)-D7 (7th day after whelping), L2: D8-D21, L3: D22-D42, L4: D43-D84.

Large litters: litters with 7-9 puppies, small litters: litters with 4-5 puppies.

* *P* values refer to comparison between the four stages through time.

a: differences between values observed in bitches with large or small litters found significant ($P < 0.05$).

Table III.xxi. Median (range) frequency (events) of 'Successful sucks' (SS) of puppies of clinically healthy Beagle-breed female dogs during their daily observation period throughout the *puerperium*, in relation to mammary gland of their dam.

Behaviour	<i>Puerperium</i> stage				<i>P</i> values [*]
	L1	L2	L3	L4	
All puppies					
R mammary glands	3.5 (0-11)	2.0 (0-7)	2.5 (0-9)	0.0 (0-6)	0.208
L mammary glands	2.0 (0-8)	2.0 (0-9)	2.0 (0-9)	0.55 (0-6)	0.561
(R+L) c1 mammary glands	2.0 (0-5)	1.0 (0-6)	1.5 (0-6)	0.5 (0-6)	0.319
(R+L) c2 mammary glands	2.0 (0-5)	1.5 (0-6)	1.5 (0-5)	0.5 (0-5)	0.291
(R+L) c3 mammary glands	1.0 (0-4)	1.0 (0-4)	0.5 (0-5)	0.0 (0-3)	0.170
(R+L) c4 mammary glands	0.5 (0-3)	0.5 (0-3)	0.0 (0-5)	0.0 (0-2)	0.960
(R+L) c5 mammary glands	0.0 (0-1)	0.0 (0-1)	0.0 (0-1)	0.0 (0-0)	0.351
Puppies in large litters					
R mammary glands	4.0 (0-11)	2.0 (0-7)	2.5 (0-7)	0.5 (0-6)	0.367
L mammary glands	2.5 (0-8)	1.5 (0-6)	1.5 (0-9)	0.5 (0-6)	0.849
(R+L) c1 mammary glands	2.0 (0-5)	1.0 (0-4)	1.5 (0-5)	0.5 (0-6)	0.751
(R+L) c2 mammary glands	2.0 (0-5)	1.0 (0-4)	1.5 (0-5)	0.5 (0-5)	0.413
(R+L) c3 mammary glands	1.0 (0-4)	0.5 (0-4)	0.5 (0-3)	0.0 (0-3)	0.397
(R+L) c4 mammary glands	1.0 (0-3)	0.5 (0-3)	0.0 (0-3)	0.0 (0-2)	0.986
(R+L) c5 mammary glands	0.0 (0-1)	0.0 (0-1)	0.0 (0-0)	0.0 (0-0)	0.877

Table continued on next page.

Table III.xxi. Median (range) frequency (events) of ‘Successful sucks’ (SS) of puppies of clinically healthy Beagle-breed female dogs during their daily observation period throughout the *puerperium*, in relation to mammary gland of their dam.

Behaviour	Puerperium stage				P values*
	L1	L2	L3	L4	
Puppies in small litters					
R mammary glands	2.5 (0-11)	1.5 (0-7)	2.0 (0-9)	0.0 (0-2)	0.797
L mammary glands	1.5 (0-6)	3.0 (0-9)	2.0 (0-5)	0.5 (0-6)	0.327
(R+L) c1 mammary glands	1.0 (0-5)	1.5 (0-6)	1.5 (0-6)	0.5 (0-3)	0.413
(R+L) c2 mammary glands	1.0 (0-5)	2.0 (0-6)	1.5 (0-5)	0.0 (0-5)	0.805
(R+L) c3 mammary glands	0.5 (0-4)	1.5 (0-3)	0.0 (0-5)	0.0 (0-1)	0.740
(R+L) c4 mammary glands	0.0 (0-2)	0.0 (0-2)	0.0 (0-5)	0.0 (0-1)	0.996
(R+L) c5 mammary glands	0.0 (0-1)	0.0 (0-0)	0.0 (0-1)	0.0 (0-0)	0.989

L1: D0 (day of whelping)-D7 (7th day after whelping), L2: D8-D21, L3: D22-D42, L4: D43-D84.

Large litters: litters with 7-9 puppies, small litters: litters with 4-5 puppies.

R: right, L: left mammary gland, c1: the caudal glands, c2 the glands cranially to c1, etc.

* P values refer to comparison between the four stages through time.

Table III.xxii. Median (range) frequency (events) of ‘Successful sucks’ of puppies of clinically healthy Beagle-breed female dogs during their daily observation period throughout the *puerperium*, in relation to mammary gland of their dam and potential association with risk of infection of the respective mammary gland.

Mammary gland	Frequency (events)	Risk of infection of the mammary gland
Rc1	1.5 (0-5) ^{a,b}	0.125 ^{a,b}
Rc2	1.5 (0-5) ^{c,d}	0.090 ^c
Rc3	0.5 (0-5) ^{a,c}	0.048 ^a
Rc4	0.0 (0-4) ^{b,d}	0.019 ^{b,c}
Lc2	1.5 (0-4)	0.071
Rc1+Rc2	1.5 (0-5) ^e	0.107 ^d
Rc3+Rc4	0.0 (0-5) ^e	0.033 ^d

Rc1: the caudal gland in the right side, Rc2 the gland cranially to Rc1, etc.; Lc2: the gland contralateral to Rc2.

Same superscripts within the same column indicate significant differences ($P < 0.05$) between respective values.

Gross appearance of the uterus and the ovaries

Externally, the uterus was pink, with longitudinal folds and mild vascularization. The two horns were symmetrical between them and laterally oblate; macroscopically, the placental sites could be appreciated even up to D84 (Figs III.33-III.37). No significant differences in the length of the uterine horns were evident among the various time-points (mean length on D7: 9.0 cm, on D35: 7.0 cm, on D84: 8.5; $P=0.485$). Mean widths of the uterine horns were different across the various time-points ($P\leq 0.001$): 2.8 / 2.7 cm (placental sites / interplacental areas) on D7, 1.7 / 1.2 cm (placental sites / interplacental areas) on D35 and 0.9 / 0.8 cm (placental sites / interplacental areas) on D84; the differences across the *puerperium* were statistically significant ($P\leq 0.001$). Detailed results are in Table III.xxiii.

There was a small amount of viscous to mucous, red to dark-brownish fluid inside the uterus of seven bitches (D4, D7, D10, D21, D28, D35 and D42). Placental sites were almost evenly distributed in the left and right uterine horn of the animals: in total 41 and 39, respectively. They were initially of dark green (D4, D7) to grey colour (D21 to D28), whilst later they were dark brown (D35 and thereafter) (Figs III.38-III.42). These were easily recognized, thickened and with 'foamy'-like surface. All placental sites of each uterus (i.e., of the same animal) were macroscopically similar. Their length progressively decreased, ranging between 8 to 20 mm in L1, 8 to 19 mm in L2, 5 to 12 mm in L3 and 0.5 to 10 mm in L4; their height (including uterine wall) ranged between 5 to 9 mm in L1, 3 to 6 mm in L2, 2 to 5 mm in L3 and 2 to 4 mm in L4 (differences in changes during the study: $P=0.009$ and $P<0.001$, for length and height of the structures, respectively). The interplacental areas were white to pink colour with mild longitudinal wrinkles thereon (Figs III.38-III.42). Their length progressively increased and ranged between 2 to 23 mm in L1, 7 to 20 mm in L2, 5 to 20 mm in L3 and 8 to 26 mm in L4; their height (i.e., the uterine wall thickness) ranged between 4 to 6 mm in L1, 2 to 4 mm in L2, 2 to 3 mm in L3 and 2 to 3 mm in L4 (differences in changes during the study: $P=0.15$ and $P=0.02$, for length and height of the structures, respectively). Detailed results are in Table III.xxiv.

No significant differences ($P>0.05$) were seen in the dimensions of the ovaries among the various time-points in the *puerperium*. *Corpora albicantia* (as previously defined [chapter I, section A]) were evenly distributed in the left and right ovaries of the animals: in total 41 and 38, respectively; their mean diameter was 4 mm on D7, 3.5 mm on D35 and 1 mm on D84 ($P=0.001$) (Figs III.42 and III.43). Detailed results are in Table III.xxv.

Figure III.33. External view of the uterus of a clinically healthy Beagle-breed female dog, on D4 of the *puerperium*. Presence of longitudinal folds and mild vascularization; the two horns are symmetrical between them and laterally oblate.



Figure III.34. External view of the uterus of a clinically healthy Beagle-breed female dog, on D14 of the *puerperium*. The uterus is pink, with mild vascularization. The two horns are symmetrical between them and laterally oblate; macroscopically, the placental sites can be appreciated.

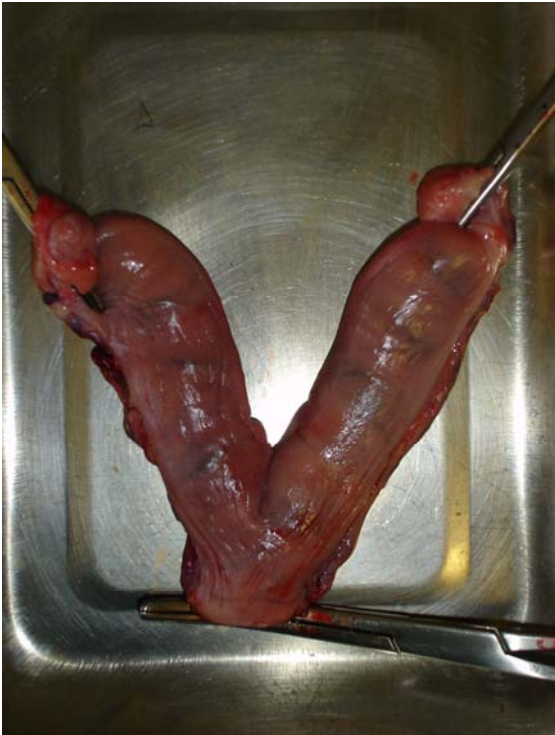

Figure III.35. External view of the uterus of a clinically healthy Beagle-breed female dog, on D28 of the *puerperium*. The uterus is pink, with mild vascularization. The placental sites can be appreciated.



Figure III.36. External view of the uterus of a clinically healthy Beagle-breed female dog, on D56 of the *puerperium*. The uterus is pink, with mild vascularization. Width of the uterine horns has decreased. The placental sites can be appreciated.

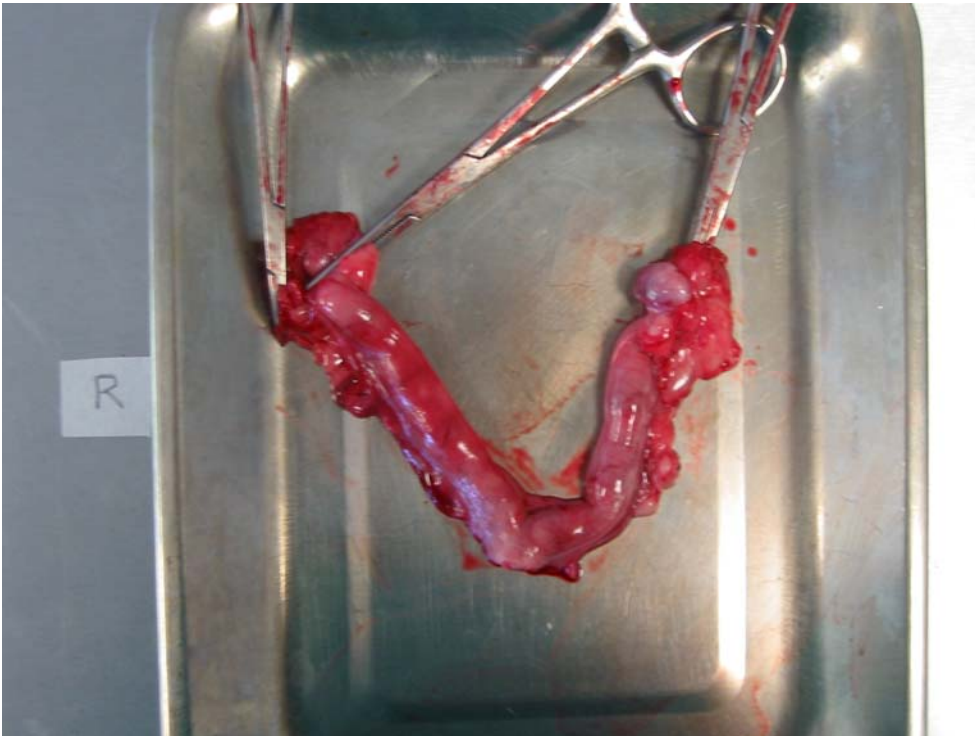

Figure III.37. External view of the uterus of a clinically healthy Beagle-breed female dog, on D84 of the *puerperium*. The uterus is pink, with mild vascularization. Width of the uterine horns has decreased further. The placental sites can be appreciated.



Figure III.38. Internal view of the uterus (placental sites with 'foamy' like surface, interplacental areas) of a clinically healthy Beagle-breed female dog, on D4 of the *puerperium*.



Figure III.39. Internal view of the uterus (placental sites with 'foamy'-like surface, interplacental areas) of a clinically healthy Beagle-breed female dog, on D14 of the *puerperium*.



Figure III.40. Internal view of the uterus (placental sites with 'foamy'-like surface, interplacental areas) of a clinically healthy Beagle-breed female dog, on D28 of the *puerperium*.

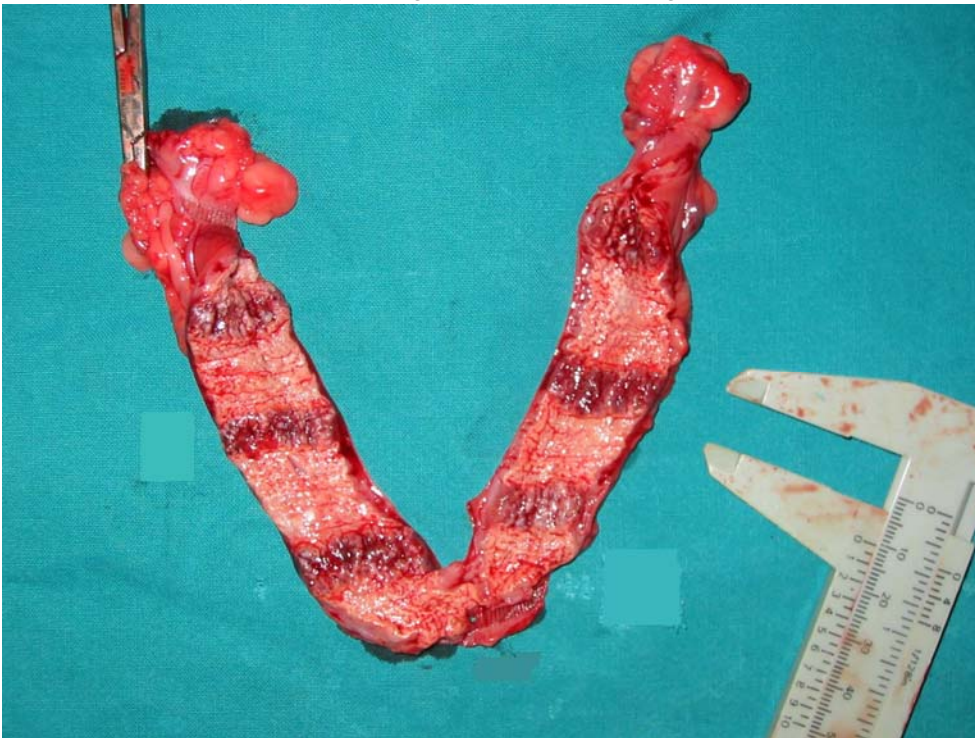

Figure III.41. Internal view of the uterus (placental sites with 'foamy'-like surface, interplacental areas) of a clinically healthy Beagle-breed female dog, on D56 of the *puerperium*.

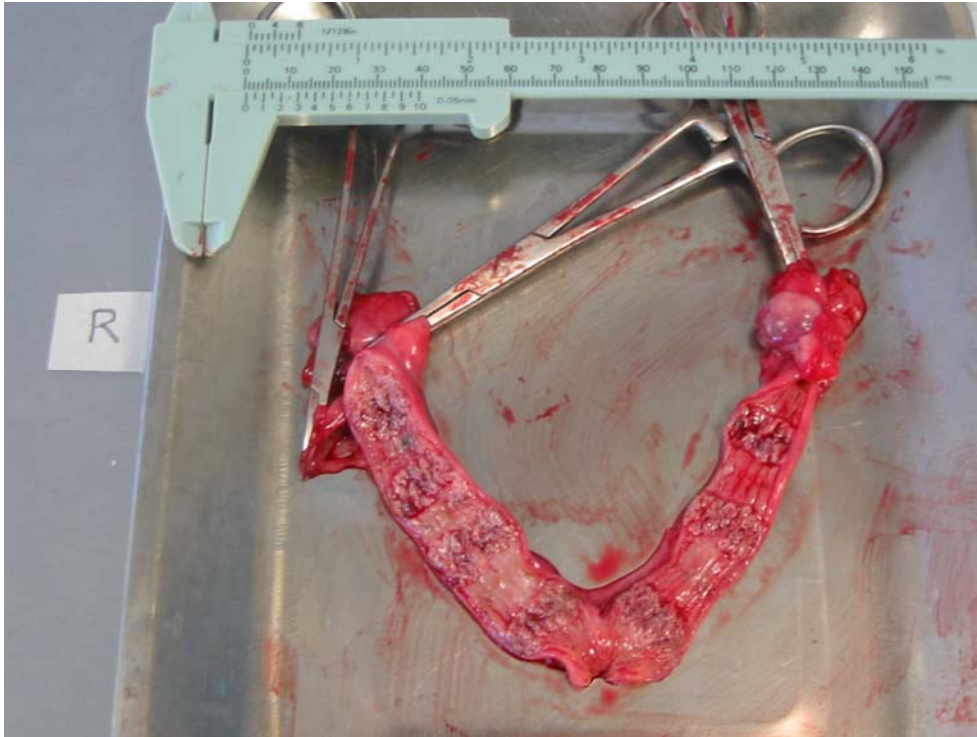

Figure III.42. Internal view of the uterus (placental sites, interplacental areas) of a clinically healthy Beagle-breed female dog, on D84 of the *puerperium*.

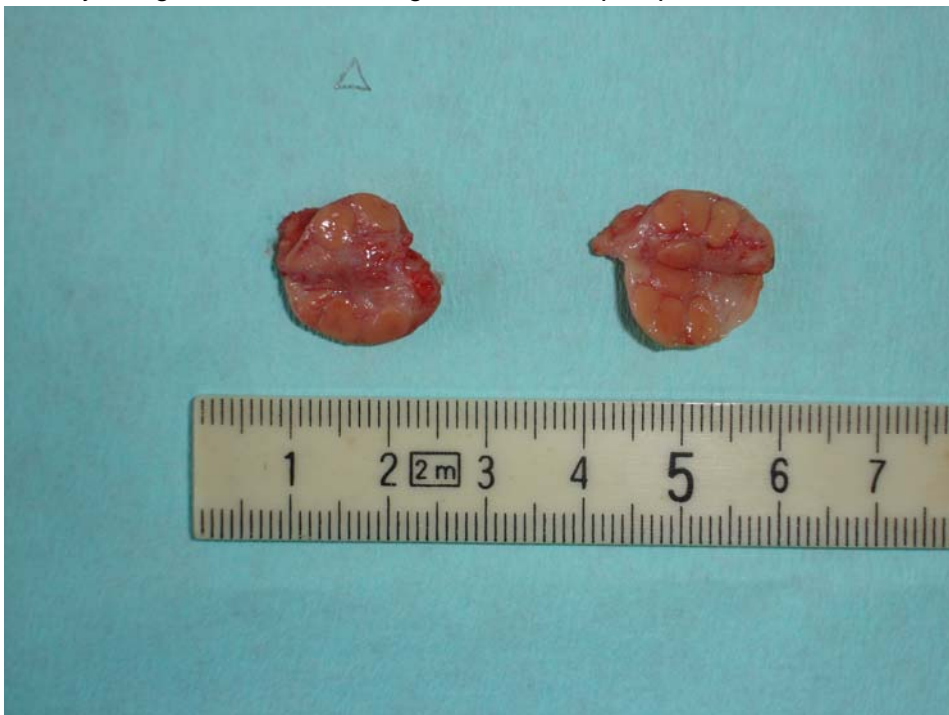

Figure III.43. External view of the ovaries of a clinically healthy Beagle-breed female dog, on D4 of the *puerperium*.



Left ovary in the right side, right ovary in the left side of the picture.

Figure III.44. View after longitudinal section of the ovaries (with *corpora albicantia*) of a clinically healthy Beagle-breed female dog, on D4 of the *puerperium*.



Left ovary in the right side, right ovary in the left side of the picture.

Table III.xxiii. Dimensions (length and width; mean±standard error of the mean) of uterine horns in the uterus of clinically healthy Beagle-breed female dogs, during the *puerperium*.

Day of the <i>puerperium</i>	Length (mm)	Width at placental sites (cm)	Width at interplacental areas (cm)
4	10.5	3.9±0.2 ^a	2.7±0.1 ^a
7	9.0	2.8±0.2 ^a	2.7±0.1 ^a
10	11.5	2.3±0.2 ^a	2.2±0.1 ^a
14	9.0	2.1±0.2 ^a	2.0±0.2 ^a
21	7.5	1.6±0.2 ^a	1.8±0.2 ^a
28	9.5	1.7±0.1 ^a	1.2±0.1 ^a
35	7.0	1.7±0.1 ^a	1.2±0.1 ^a
42	7.0	1.0±0.1 ^a	1.0±0.1 ^a
56	7.5	0.8±0.1 ^a	0.7±0.1 ^a
70	10.0	0.9±0.1 ^a	0.7±0.1 ^a
84	8.5	0.9±0.1 ^a	0.8±0.1 ^a

Length was calculated as average of the two horns; width was measured before dissection of the horns, at each placental site and each interplacental area and average of all respective measurements was calculated.

a: progressive changes during the study $P<0.05$.

Table III.xxiv. Dimensions (mean±standard error of the mean) of placental sites and interplacental areas in the uterus of clinically healthy Beagle-breed female dogs, during the *puerperium*.

Day of the <i>puerperium</i>	Dimensions of placental sites		Dimensions of interplacental areas	
	Length (mm)	Height (mm)	Length (mm)	Height (mm)
4	15±0.2 ^a	7±0.1 ^a	14±0.2	5±0.1 ^a
7	12±0.2 ^a	6±0.1 ^a	10±0.3	4±0.0 ^a
10	16±0.2 ^a	5±0.1 ^a	13±0.2	3±0.1 ^a
14	15±0.1 ^a	5±0.1 ^a	12±0.2	3±0.0 ^a
21	10±0.2 ^a	4±0.1 ^a	11±0.2	3±0.1 ^a
28	11±0.2 ^a	4±0.1 ^a	17±0.2	2±0.0 ^a
35	9±0.2 ^a	4±0.1 ^a	12±0.2	2±0.0 ^a
42	9±0.2 ^a	4±0.1 ^a	10±0.1	2±0.0 ^a
56	9±0.1 ^a	3±0.1 ^a	14±0.2	2±0.0 ^a
70	7±0.1 ^a	3±0.1 ^a	16±0.1	2±0.0 ^a
84	5±0.1 ^a	3±0.1 ^a	17±0.1	2±0.0 ^a

Length of each placental site and each interplacental area was calculated parallelly to the axis of the uterine horn; height of each placental site and each interplacental area included the underlying uterine wall.

a: progressive changes during the study $P<0.05$.

Table III.xxv. Dimensions of ovaries and *coprorae albicans* of clinically healthy Beagle-breed female dogs, during the *puerperium*.

Day of the <i>puerperium</i>	Dimensions of ovaries (mm)	Mean diametre±standard error of the mean (mm) of <i>coprorae albicans</i>
4	14x9x6	4±0.2 ^a
7	15x12x8	4±0.2 ^a
10	18x11x7	4±0.2 ^a
14	17x11x6.5	4±0.2 ^a
21	14.5x8x6.5	3±0.2 ^a
28	15.5x8.5x7	3±0.2 ^a
35	17x9.5x6	3.5±0.2 ^a
42	13.5x9.5x4	3±0.2 ^a
56	22x8.5x6	2±0.2 ^a
70	13.5x8x6	2±0.1 ^a
84	12x7x5	1.5±0.1 ^a

a: progressive changes during the study $P<0.05$.

Bacteriological and cytological findings in uterine content samples

Bacteriological findings

Bacteria were isolated from both swabs cultured from the uterine content of the bitch operated on D4 and from the uterine content of the bitch operated on D7. On each occasion, bacteria isolated from both swabs of the same animal were similar; they were identified as *E. coli* (on D4) or *T. pyogenes* (on D7). It is noteworthy that, in both animals, same bacteria had also been isolated from the samples collected from the anterior part of the vagina of the respective animals on the sampling performed prior to the operation day (i.e., on D2 and D4, respectively).

Cytological findings

In swab smears from the uterine content, the majority (65%-75%) of cells observed were initially leucocytes. Among leucocytes, neutrophils predominated (85%-90%) in L1, L2, L3, whilst lymphocytes predominated (60%-65%) in L4. Normal and degenerated uterine epithelial cells (Fig. III.45), characteristically clustered, and erythrocytes were also observed in smears from samples collected in all periods of the *puerperium*; trophoblast-like cells were evident in L1, L2, L3 (Fig. III.45), although their number was estimated to progressively decrease. Uterine epithelial cells predominated on D56 and thereafter. Changes in epithelial cell counting scores during the study

were not significant ($P=0.737$), whilst those in leucocyte counting scores were ($P=0.04$). Details are in Table III.xxvi.

Figure III.45. A combination of uterine epithelial cells, characteristically clustered, in a swab sample from uterine content of a clinically healthy Beagle-breed female dog, on D2 of the *puerperium* (Giemsa, 40x objective, photograph taken on a Zeiss-Axiostar Microscope).

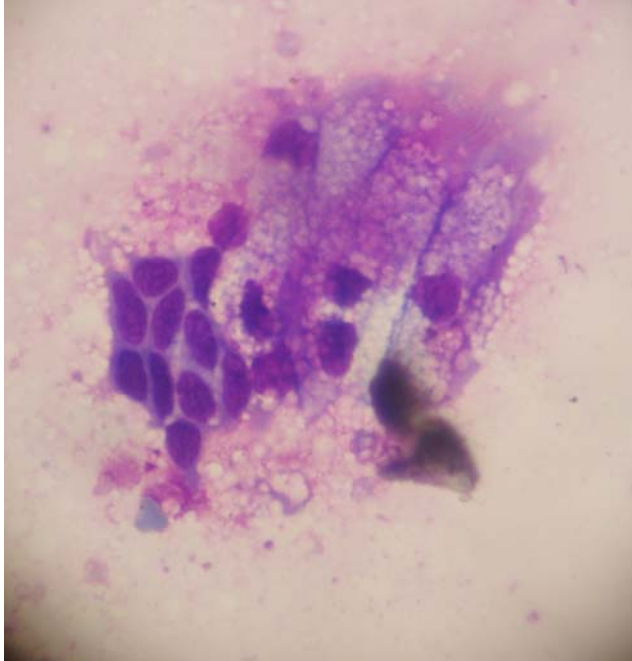

Table III.xxvi. Cell counting scores in swab smears from uterine content in clinically healthy Beagle-breed female dogs, during the *puerperium*.

Day of the <i>puerperium</i>	Epithelial cell counting score	Leucocyte counting score
4	1	4 ^a
7	2	4 ^a
10	2	2 ^a
14	1	2 ^a
21	1	3 ^a
28	2	3 ^a
35	1	3 ^a
42	1	1 ^a
56	2	1 ^a
70	1	2 ^a
84	2	2 ^a

Scoring scale: '0' (no cells observed in the slide), '1' (on average, ≤ 3 cells per optical field), '2' (on average, 4-7 cells per optical field), '3' (on average, 8-15 cells per optical field) and '4' (on average, ≥ 16 cells per optical field), using the 40x objective lens of a Zeiss-Axiostar Microscope.

a: progressive changes during the study $P < 0.05$.

Histological, histometric and ultrastructural findings in uterus and ovary tissue samples

During L1, the perimetrium was thickened and prominent. The myometrium was very thickened; on D4, its thickness exceeded the optical field of the histometric equipment and could not be measured, whilst on D7 its thickness was 1887 μm . The vascular layer was prominent, with increased number of grossly dilated vessels and marked hyperhaemia. There were no inflammatory cells in the myometrium. The thickened endometrium showed folding, as well as increased vascularisation in the lamina propria; the uterine glands were evident with intact, simple, cuboidal epithelium (Fig. III.46). High numbers of inflammatory cells (mainly lymphocytes, with some neutrophils and occasional macrophages) were observed subepithelially (Fig. III.47). A simple, cuboidal to columnar epithelium was seen; many epithelial cells were enlarged, clustered and with a 'foamy' cytoplasm. Clusters of 'foamy' cells were evident along the entire epithelial lining (Fig. III.48), as well as within the lumen. Increased desquamation of epithelial cells, as well as occasional erythrocytes were seen into the lumen (Fig. III.49).

A few follicles were evident in the cortex of each ovary. Large *corpora albicantia* were present in the cortex and in the medulla of each ovary. There was a large amount of luteal cells, which appeared in regression (Fig. III.50). The cytoplasm of cells within the *corpora albicantia* were full of vacuoles; some nuclei were slightly pycnotic and placed eccentrically. The radiating spaces in the centre of the *corpora albicantia* were reduced and were not always evident. Some endothelial-like cells were observed. In the medulla, there were many vessels with thickened wall, divided from each other by loose connective tissue.

During L2, the intensity of the above findings progressively decreased. Thickness of the myometrium on D10 was 1728 μm ; however, number and diameter of obvious vessels in the vascular layer were reduced. The endometrium was still thickened, with folding and increased vascularity. The uterine glands were evident with intact, simple, cuboidal epithelium. Inflammatory cells (lymphocytes, macrophages) were present. A simple cuboidal to columnar epithelium was seen; some epithelial cells were enlarged and with a 'foamy' cytoplasm; the epithelial lining was not continuous. Desquamation of epithelial cells into the lumen was frequently observed.

Follicles in different sizes, mostly medium to small, and at various stages of development were evident in the cortex of each ovary. Large *corpora albicantia* were present in the cortex and in the medulla of each ovary. Cells in the luteal tissue had regressed and had vacuolated cytoplasm and pycnotic, eccentric and irregularly-shaped nuclei. No radiating spaces in the centre of the *corpora albicantia* were evident. More endothelial-like cells were evident in the *corpora albicantia*.

In the medulla, there were vessels with thickened wall, divided from each other by loose connective tissue.

During L3, thickness of all layers of the myometrium was reduced; on D28, it was 1621 μm . Inflammatory cells were first evident in the inner layer of the myometrium on D28, with their number increasing subsequently to that. The endometrium was still thickened, with the uterine glands evident with simple epithelium. A simple, cuboidal to columnar epithelium was seen; columnar, epithelial cells were observed with apical placement to their nuclei. 'Foamy' epithelial cells were also observed, but only at the part of the epithelium lining corresponding to the placental site (Figs III.51 and III.52). Little desquamation into the lumen was seen.

Follicles in different sizes, mostly medium to small, and at various stages of development were evident in the cortex of each ovary. A decrease in the size of the *corpora albicantia* was seen in the deeper cortex and in the medulla of each ovary. The cells of the luteal tissue had regressed. The *corpora albicantia* had a more loose, than in previous periods, structure, with little connective tissue among cells. No radiating spaces in the centre of the *corpora albicantia* were evident, but increased number of endothelial-like cells were observed. In the medulla, many vessels, divided from each other by dense connective tissue, were obvious.

During L4, thickness of the myometrium was further decreased and, on D70, it was 1255 μm . Progressive reduction of thickness of myometrium across the stages of the puerperium was statistically significant ($P=0.005$) Diameter of blood vessels in the vascular layer was minimal. Inflammatory cells were observed in the inner layer of the myometrium. Some inflammatory cells were present (lymphocytes, macrophages) subepithelially. Uterine glands were evident, although their diameter had decreased (Figs III.53 and III.54). A simple, cuboidal epithelium was seen; some 'foamy' epithelial cells were also observed (never seen in clusters), at the part of the epithelium lining corresponding to the placental site (Fig. III.55). No desquamation into the lumen was observed.

Many follicles, in different stages of development, were evident in the cortex of each ovary (Figs III.56 and III.57). Small *corpora albicantia* were also observed. The luteal tissue had regressed; each cell contained one large vacuole and pycnotic, eccentric and irregularly-shaped nucleus (Fig. III.57). The *corpora albicantia* had a loose structure, with increased connective tissue among cells (collagen fibres and fibroblasts). Some vessels were evident in the medulla, where connective tissue was very dense.

Diameter of the uterine glands' transverse sections progressively reduced during the puerperium; it was 79 μm on D7, 53 μm on D56 and 52 μm on D84 ($P=0.032$). Moreover,

significant differences were also seen in the height of glandular epithelial cells: 9.4 μm on D4, 6.2 μm on D35, 6.4 μm on D70 ($P=0.035$). Details of histometric measurements are in Table xxvii.

Fig. III.46. Histological section of the uterus of a clinically healthy Beagle-breed female dog on D7 of the *puerperium*; uterine glands with intact, simple, cuboidal epithelium and grossly dilated vessels in the endometrium (H&E, 100 \times objective, photograph taken on a Zeiss-Axiostar Microscope).

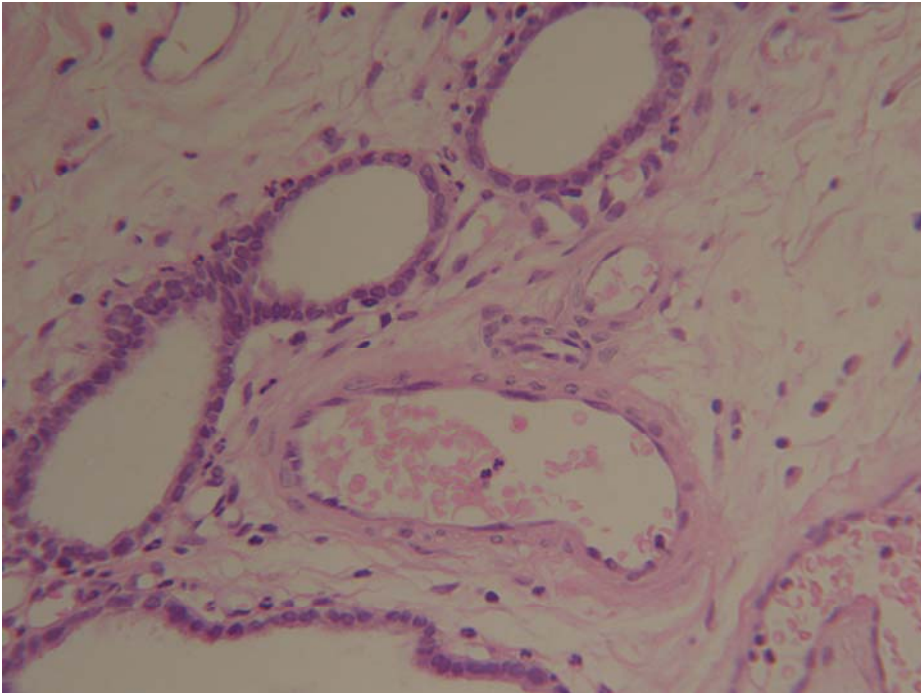

Fig. III.47. Histological section of the uterus of a clinically healthy Beagle-breed female dog on D7 of the *puerperium*; increased infiltration by inflammatory cells and hyperhaemia subepithelially (H&E, 100x objective, photograph taken on a Zeiss-Axiostar Microscope).

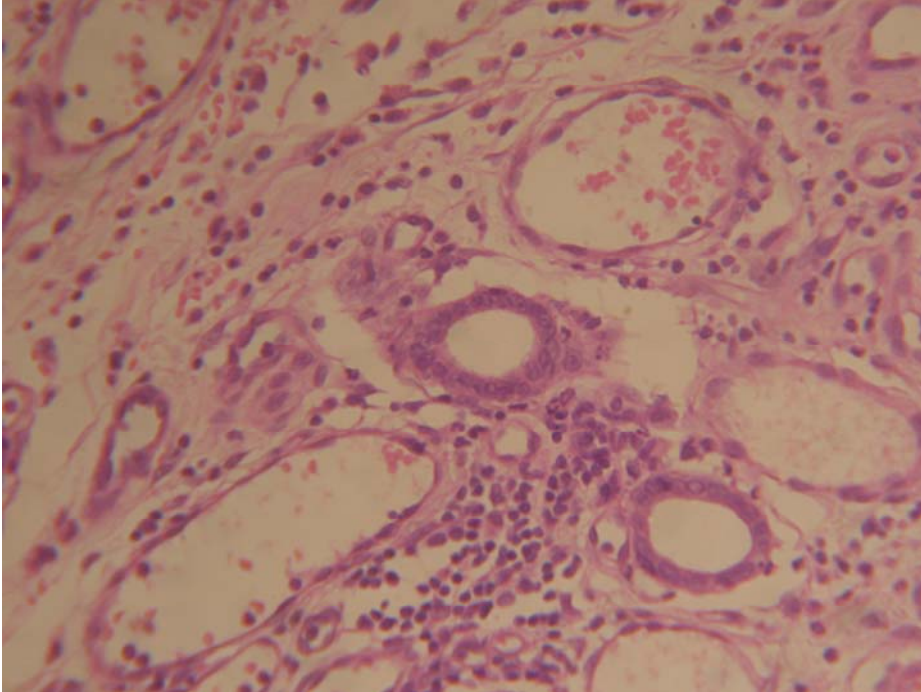

Fig. III.48. Histological section of the uterus of a clinically healthy Beagle-breed female dog on D7 of the *puerperium*; 'foamy' cells in the epithelium (H&E, 250x objective, photograph taken on a Zeiss-Axioplan 2 Microscope).

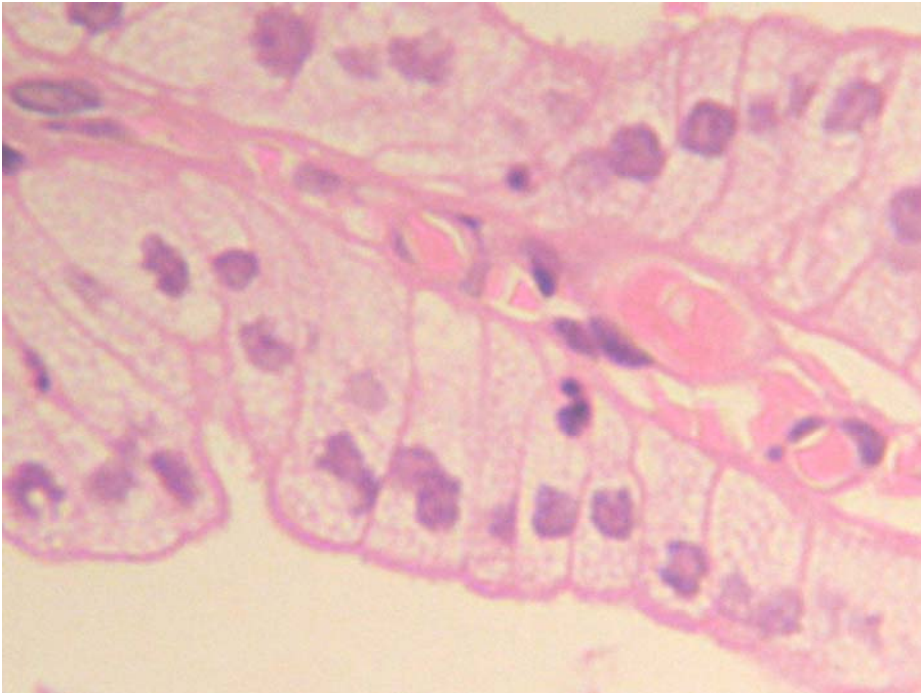

Fig. III.49. Histological section of the uterus of a clinically healthy Beagle-breed female dog on D7 of the *puerperium*; 'foamy' cells on epithelium and desquamated cells clustered in the uterine lumen (H&E, 40x objective, photograph taken on a Zeiss-Axiostar Microscope).

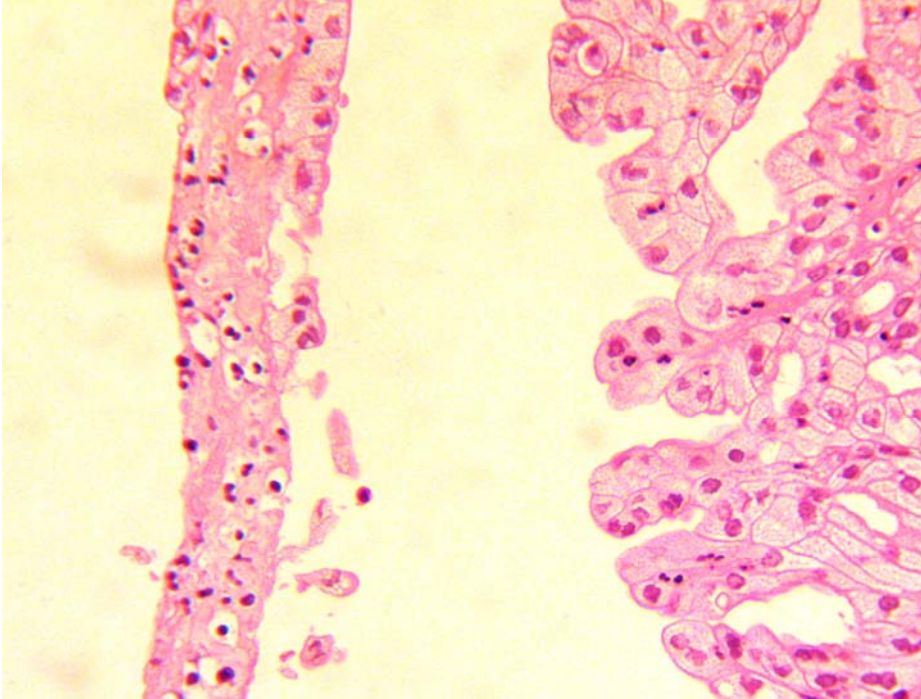

Fig. III.50. Histological section of an ovary of a clinically healthy Beagle-breed female dog on D4 of the *puerperium*; increased quantity of regressing luteal tissue (H&E, 40x objective, photograph taken on a Zeiss-Axiostar Microscope).

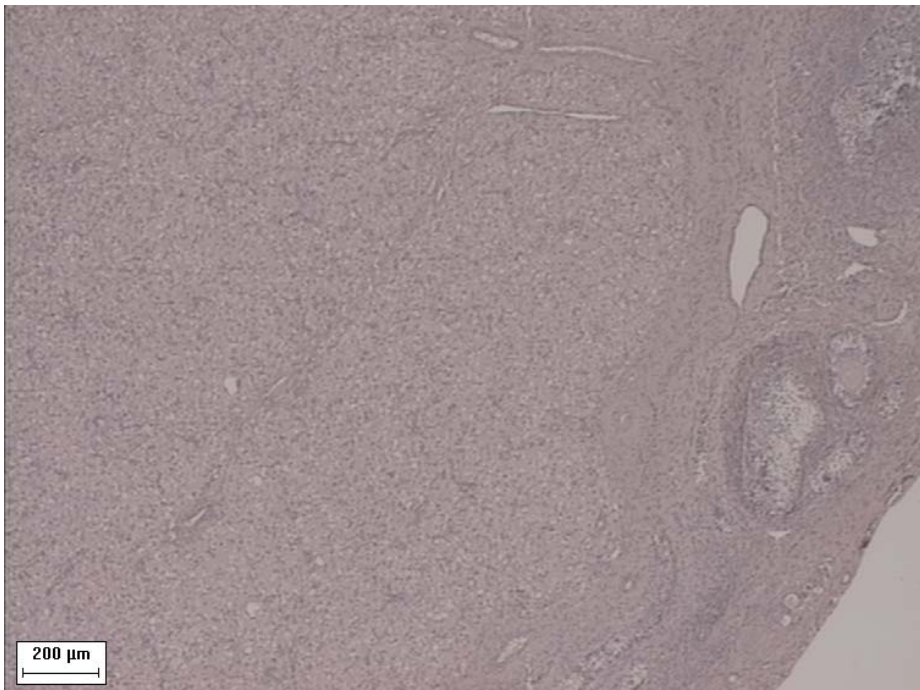
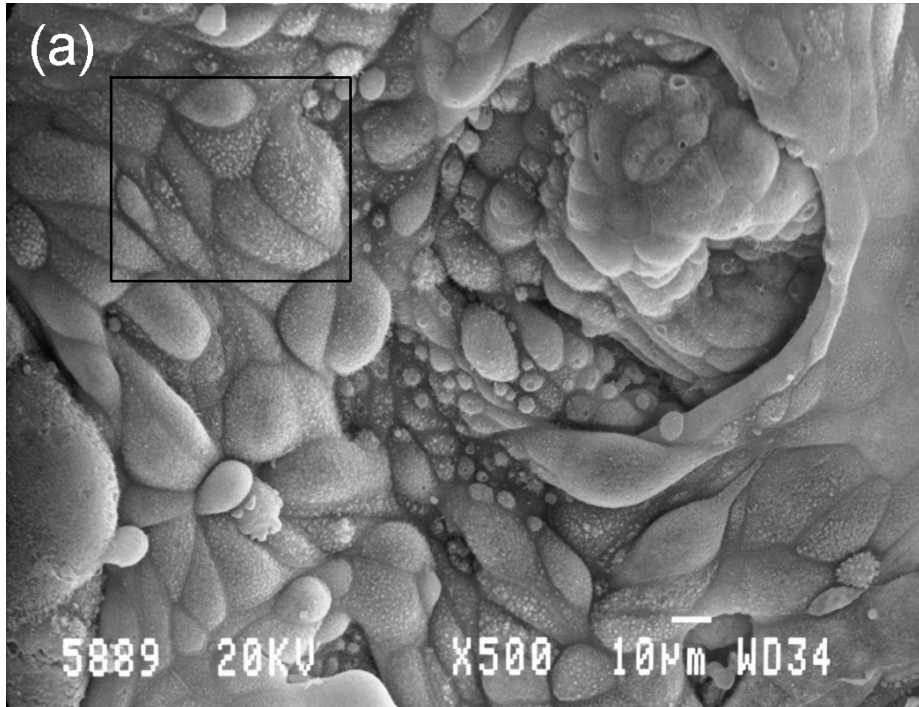

Fig. III.51. Ultrastructural profile of the surface of the epithelium at a placental site in the uterus of a clinically healthy Beagle-breed female dog on D28 of the puerperium ([a] SEM, 500x objective, photograph taken on a JEOL, JSM 840 scanning electron microscope; [b] Higher magnification of squared area in [a] 1700x objective).

[a]



[b]

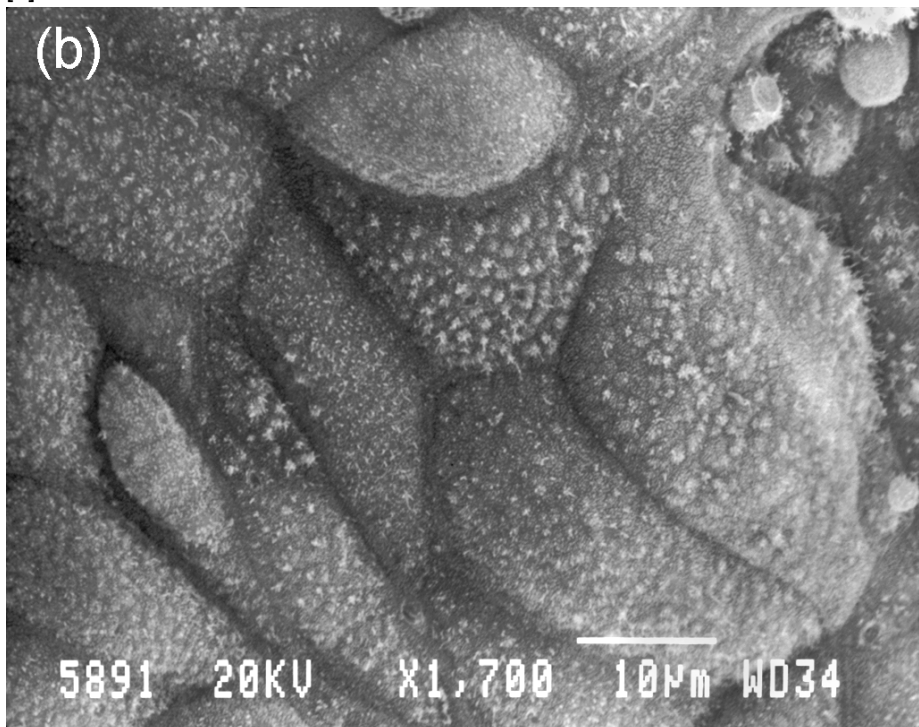

Fig. III.52. Ultrastructural profiles of 'foamy' cells at a placental site in the uterus of a clinically healthy Beagle-breed female dog on D28 of the puerperium (SEM, 1300x objective, photograph taken on a JEOL, JSM 840 scanning electron microscope)

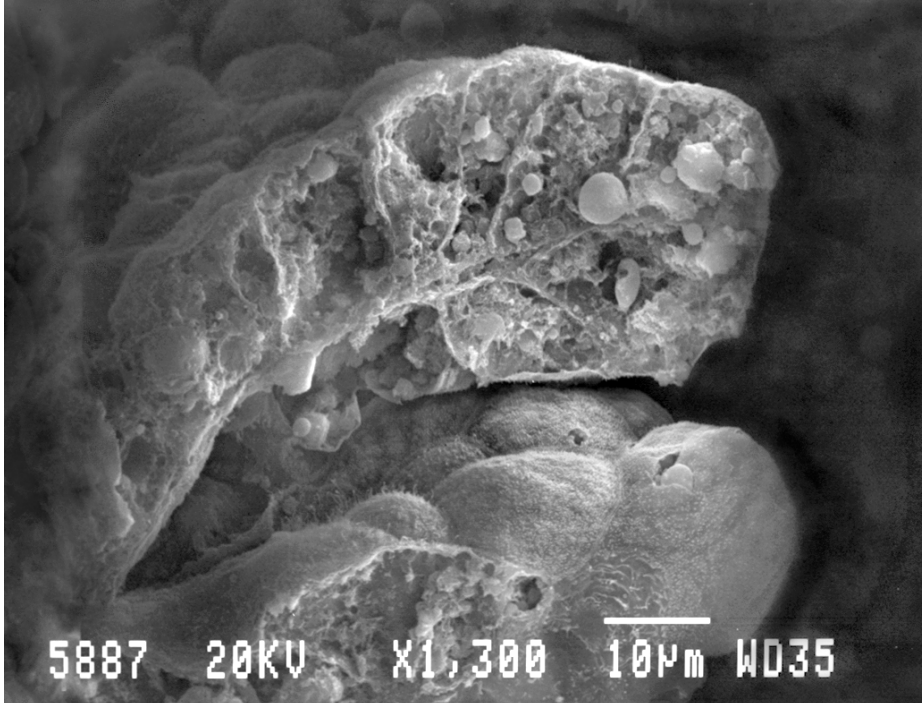

Fig. III.53. Histological section of the uterus of a clinically healthy Beagle-breed female dog on D70 of the *puerperium*; uterine glands with intact, simple, cuboidal epithelium in the endometrium and infiltration of the lamina propria by inflammatory cells (H&E, 100x objective, photograph taken on a Zeiss-Axiostar Microscope).

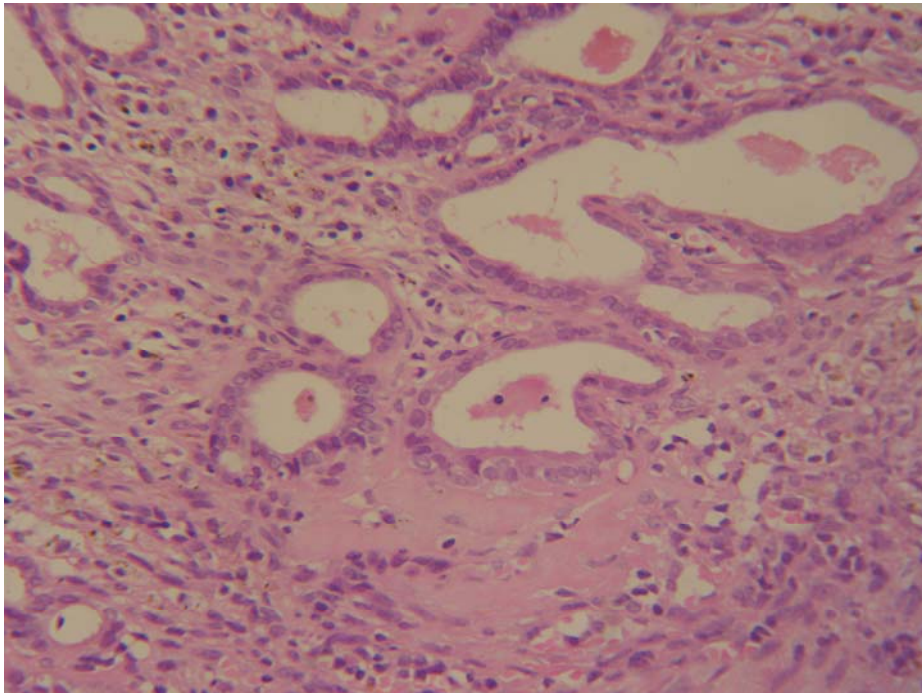

Fig. III.54. Ultrastructural profiles of uterine glands in the uterus of a clinically healthy Beagle-breed female dog on D70 of the puerperium ([a] SEM, 110x objective, photograph taken on a JEOL, JSM 840 scanning electron microscope; [b] Higher magnification of squared area in [a] 1500x objective)

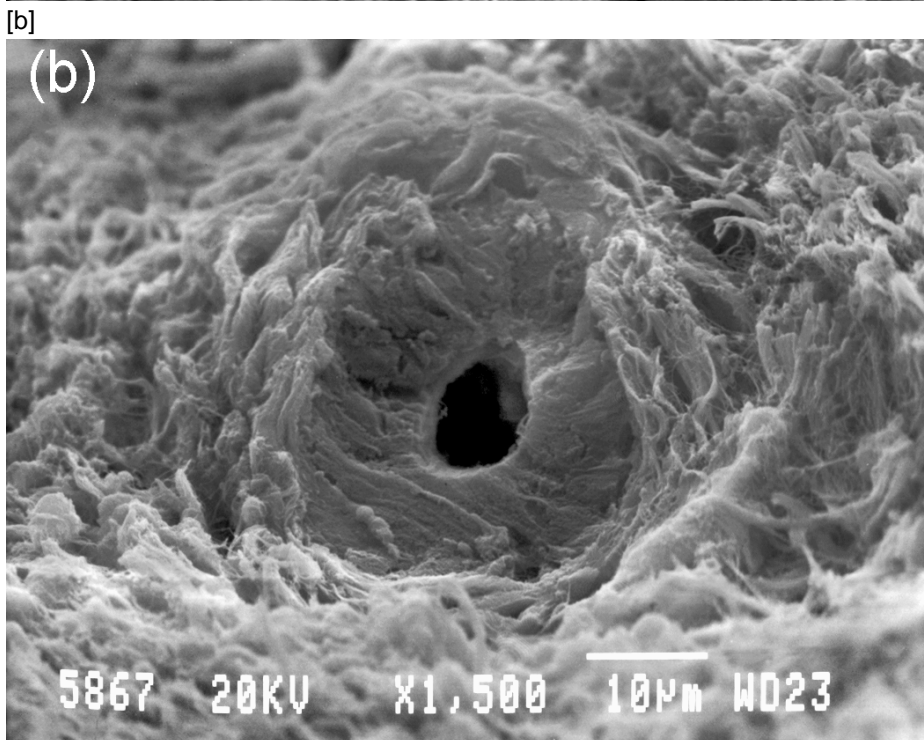
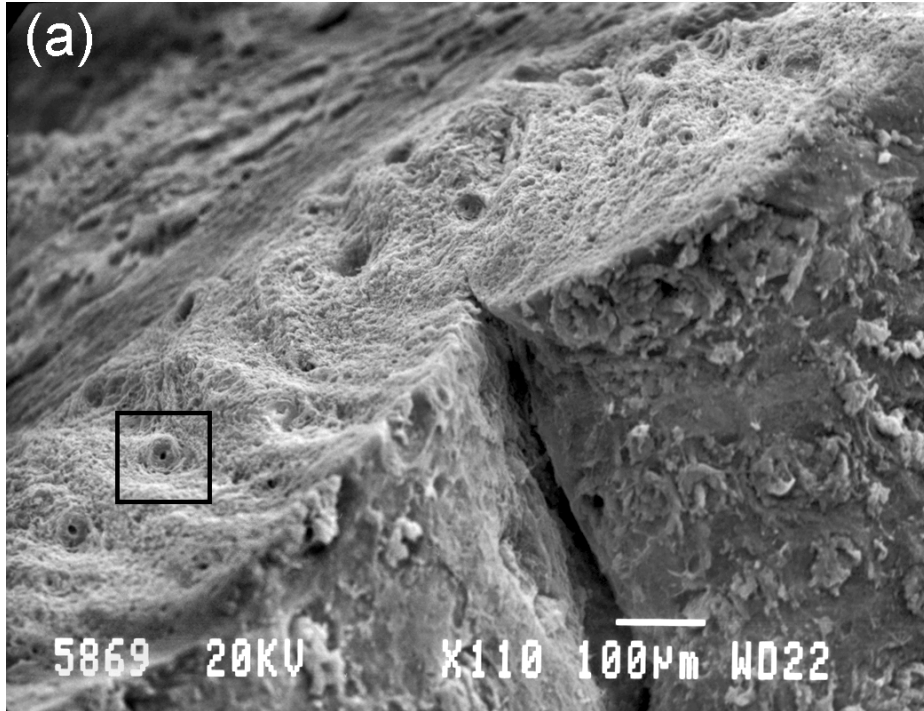

Fig. III.55. Histological section of the uterus of a clinically healthy Beagle-breed female dog on D70 of the *puerperium*; simple, cuboidal, intact epithelium of the endometrium (H&E, 40× objective, photograph taken on a Zeiss-Axiostar Microscope).

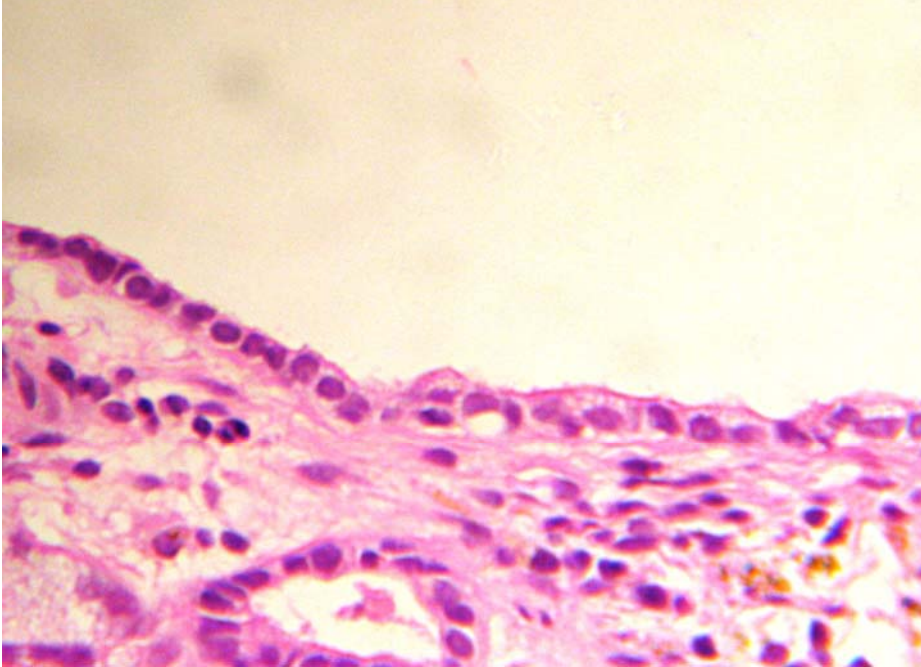

Fig. III.56. Histological section of an ovary of a clinically healthy Beagle-breed female dog on D84 of the *puerperium*; follicles at various stages of development (H&E, 40× objective, photograph taken on a Zeiss-Axiostar Microscope).

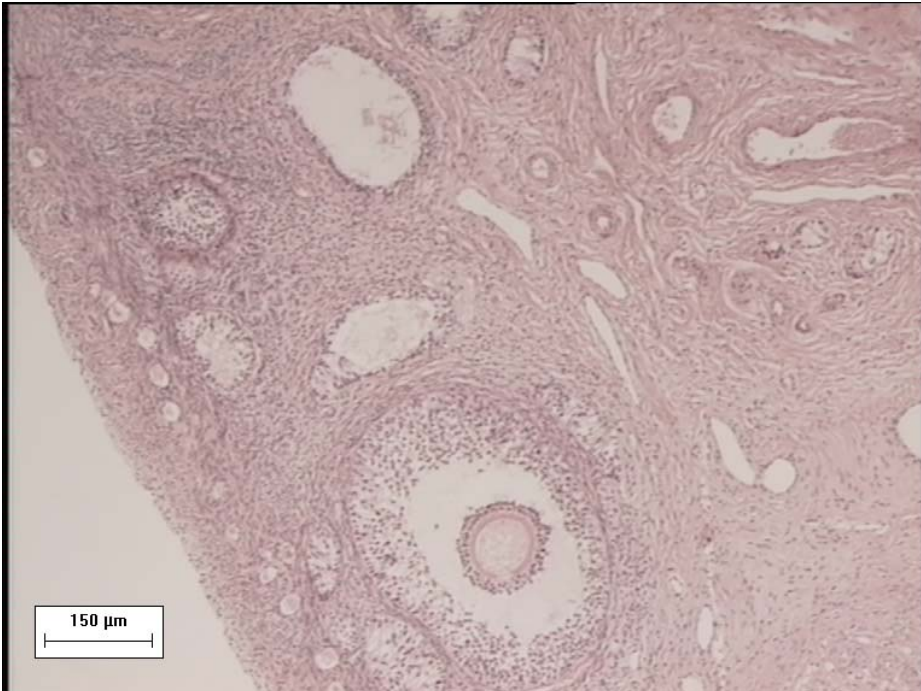

Fig. III.57. Histological section of an ovary of a clinically healthy Beagle-breed female dog on D84 of the *puerperium*; follicles at various stages of development and regressed luteal tissue (H&E, 40× objective, photograph taken on a Zeiss-Axiostar Microscope).

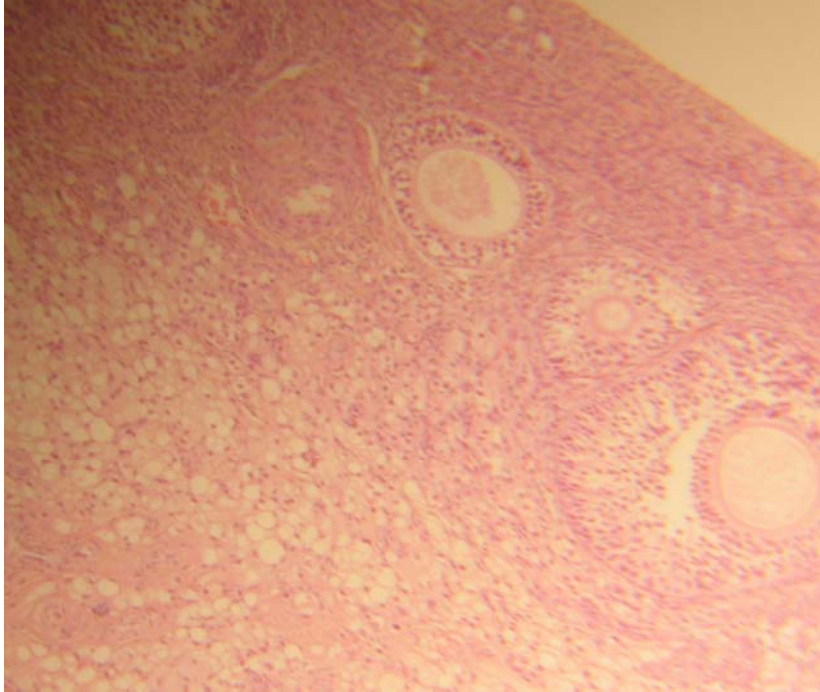

Table III.xxvii. Median (range) diametre of uterine glands and of height of epithelial cells in these glands in the uterus of clinically healthy Beagle-breed female dogs during the *puerperium*.

Day of the <i>puerperium</i>	Thickness of myometrium (µm)	Diametre of uterine glands (µm)	Height of epithelial cells (µm)
4	-	65.6 (21.1-101.0) ^a	9.4 (6.7-13.5) ^a
7	1887 (1832-2076) ^a	79.0 (18.9-102.5) ^a	9.4 (7.9-14.3) ^a
10	1728 (1560-1887) ^a	57.9 (33.6-82.0) ^a	7.0 (6.6-8.5) ^a
14	2117 (1832-2239) ^a	64.6 (26.8-138.4) ^a	7.0 (4.6-9.7) ^a
21	1483 (1232-1711) ^a	46.0 (31.4-103.9) ^a	7.5 (5.7-11.5) ^a
28	1621 (1353-1911) ^a	55.0 (34.4-128.4) ^a	5.3 (4.3-7.1) ^a
35	1146 (1012-1606) ^a	44.3 (29.6-97.2) ^a	6.2 (4.4-8.5) ^a
42	1982 (1557-2374) ^a	56.1 (20.3-81.3) ^a	5.7 (4.2-8.3) ^a
56	1503 (968-2012) ^a	53.4 (22.4-84.1) ^a	5.7 (4.7-6.9) ^a
70	1255(1151-1455) ^a	49.1 (21.5-75.4) ^a	6.9 (5.4-9.0) ^a
84	1712 (1045-2113) ^a	52.0 (15.5-85.2) ^a	6.4 (4.4-9.5) ^a

On D4, thickness exceeded the optical field of the histometric equipment and could not be measured, a: progressive changes during the study $P < 0.05$.

Gross appearance of the mammary glands

The mammary glands appeared rectangular to almost square, with pink to mildly red colour; from D56 of the *puerperium*, pale yellow colouration was also evident in some areas of the mammary glands (Figs III.58-III.60). The inguinal lymph node appeared macroscopically normal. Mean (median, range) of number of orifices on each teat was 10.9 (10.5, 4-23), although great variations were evident within animals: median number of teat orifices per dog varied from 6 to 21.

There was no association between the number of teat orifices and the risk of infection of the respective mammary gland: bacteria were isolated from 14 of the 24 mammary glands with ≤ 10 orifices in the respective teat and from 12 of the 24 mammary glands with ≥ 11 orifices in the respective teat ($P > 0.55$). Median (range) number of teat orifices in mammary glands from which bacteria were isolated at least once and from which bacteria were never isolated were 9.5 (4-23) and 11.5 (6-22), respectively ($P = 0.146$). Similarly, there was no association between the number of teat orifices and the risk of repeated infection of the respective mammary gland; none of the comparisons performed as above yielded significant differences ($P > 0.22$).

Dimensions of the mammary glands were greatest during D14 to D42; then, progressively, decreased. From D4 to D42, dimensions of Rc2 were greater than those of Rc1, a pattern which was reversed from D56 onwards; in general, dimensions of Rc1 and Rc2 were greater than those of Rc3. The decrease of dimensions of the mammary glands observed during the *puerperium*, was significant ($P < 0.001$). Detailed results are in Table III.xxviii.

Figure III.58. View of the dorsal side of mammary glands of a clinically healthy Beagle-breed female dog, on D14 of the *puerperium*.



Rc1: the caudal gland in the right side, Rc2 the gland cranially to Rc1, etc.; Lc2: the gland contralateral to Rc2.

Figure III.59. View of the dorsal side of mammary glands of a clinically healthy Beagle-breed female dog, on D56 of the *puerperium*.

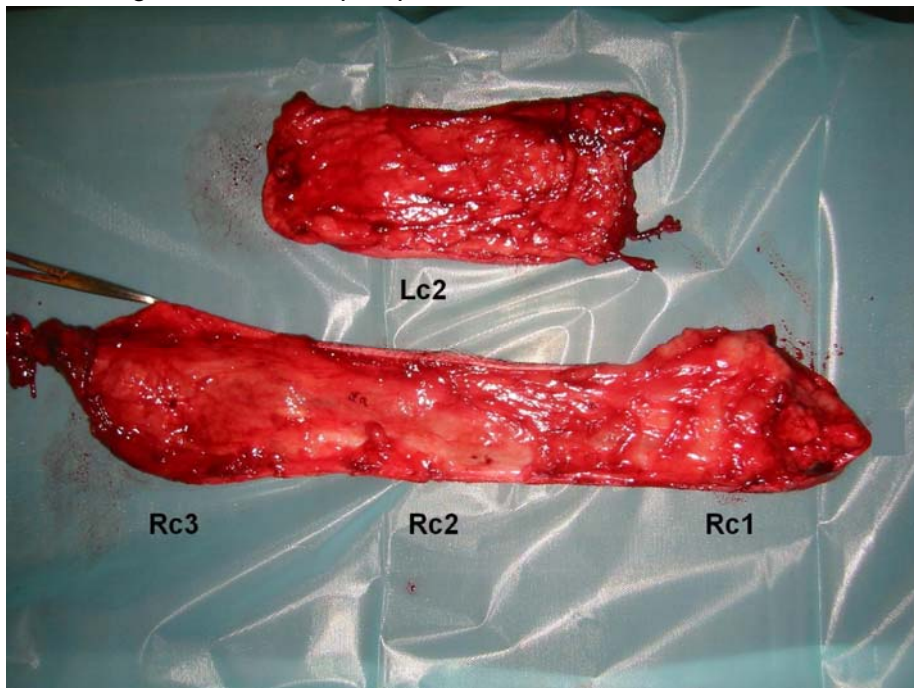

Rc1: the caudal gland in the right side, Rc2 the gland cranially to Rc1, etc.; Lc2: the gland contralateral to Rc2.

Figure III.60. View of the dorsal side of mammary glands of a clinically healthy Beagle-breed female dog, on D84 of the *puerperium*.

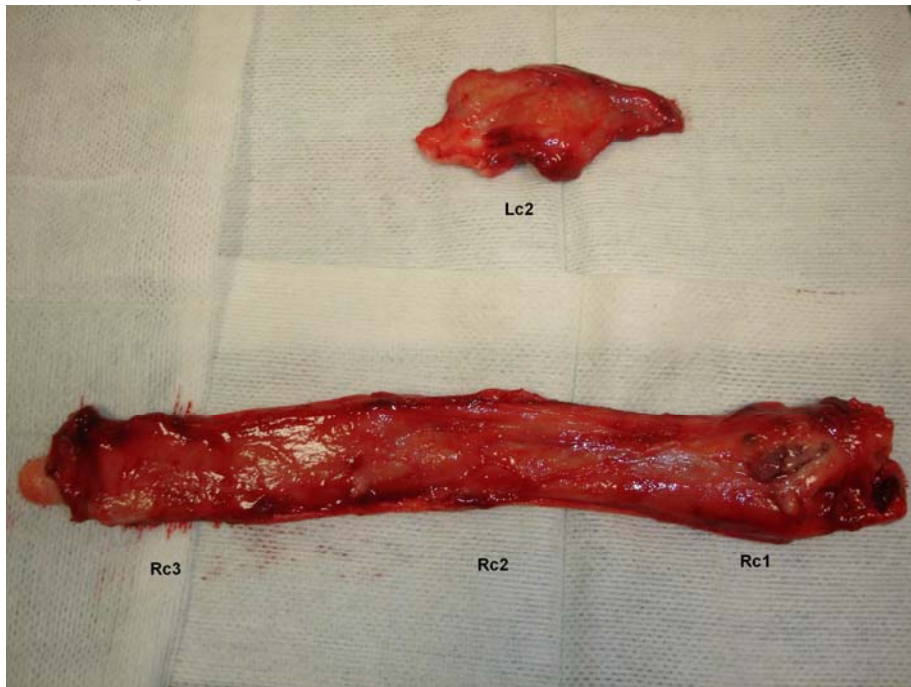

Rc1: the caudal gland in the right side, Rc2 the gland cranially to Rc1, etc.; Lc2: the gland contralateral to Rc2.

Table III.xxviii. Dimensions (length×width) of right side mammary glands of clinically healthy Beagle-breed female dogs, during the *puerperium*.

Day of the <i>puerperium</i>	Mammary gland		
	Rc1	Rc2	Rc3
4	6.8×6.0 cm	7.5×6.0 cm	9.0×6.0 cm
7	10.4×6.0 cm	8.8×6.0 cm	9.4×6.0 cm
10	10.0×5.8 cm	9.0×6.0 cm	9.9×5.5 cm
14	9.7×6.2 cm	10.4×5.2 cm	9.5×6.2 cm
21	10.0×5.5 cm	16.0×5.5 cm	10.3×5.6 cm
28	10.2×6.0 cm	14.9×6.0 cm	10.2×5.9 cm
35	8.5×5.8 cm	13.5×6.0 cm	9.7×5.7 cm
42	8.7×6.0 cm	12.9×5.8 cm	9.0×6.0 cm
56	8.0×6.0 cm	7.0×5.5 cm	6.8×5.3 cm
70	7.5×4.9 cm	6.5×4.2 cm	6.0×4.0 cm
84	7.0×3.3 cm	5.8×3.3 cm	5.7×2.5 cm

Rc1: the caudal gland in the right side, Rc2 the gland cranially to Rc1, etc.

Bacteriological findings in mammary parenchyma samples

No bacteria were isolated from any mammary parenchyma tissue sample of any bitch, collected at the mastectomies performed during the *puerperium*.

Histological, histometric and ultrastructural findings in mammary parenchyma tissue samples

In all mammary glands studied, all lobes and lobules within the same sample had similar histological features. Similarities were evident in the mammary glands of the same animal: up to D42, all mammary glands of the same animal were in full lactation, whilst on D70 and thereafter, all mammary glands of the same animal showed evidence of involution. Specifically on D56, differences were observed among the mammary glands of the animal, i.e. three mammary glands showed findings of being in full lactation, whilst a fourth showed evidence of involution.

Full ductal proliferation was evident in all the mammary glands of all bitches studied. Ducts extended into the subcutaneous adipose tissue. Small blood vessels in the sub-epithelial tissues were also observed in all mammary glands. Inflammatory cells were observed in the inter-alveolar space of all mammary glands; proportions of cells were as follows: 50-65% macrophages, 35-50% lymphocytes and <1% neutrophils. Inflammatory cells (same proportions as above) were also observed intra-alveolarly in 41/48 (85.5%) mammary glands studied. Of these glands, 15 were in [L1+L2] (of 20 in total; i.e., 75%), 10 were in L3 (of 12 in total; i.e., 83%) and 16 were in L4 (of 16 in total; i.e., 100%).

Until D42 of the *puerperium*, mammary lobules were separated with a scant amount of connective tissue (like a narrow band) (Fig. III.61). Inflammatory cells were scattered in the inter-alveolar space. Alveoli were well developed and distended; they appeared to have a spherical to slightly ovoid structure, with myoepithelial cells grasping them around (Figs III.62 and III.63). In the lumen of some alveoli, lacteal content (fat globules) was observed (Fig. III.61). The epithelial cells were uniform, cubical to slightly parallelepiped in shape (Figs III.62 and III.63).

Differences were observed among the mammary glands of the dog operated on D56. In three mammary glands (Rc1, Rc2, Lc2), findings were similar to those presented above. In the fourth mammary gland (Rc3), there was evidence of involution as described herebelow.

From D70 of the *puerperium*, the between-lobules connective tissue was abundant and dense (like a wide band); it occupied the major part of each optical field. Increased numbers of fibroblasts were observed therein (Fig. III.64). The stroma of connective tissue within the lobules contained large numbers of inflammatory cells (primarily macrophages and lymphocytes). Alveoli appeared to be irregularly-shaped and collapsing, shrunken or fully collapsed (Figs III.64 and III.65). The few epithelial cells in each alveolus were flattened and slender.

In ultrastructural profile sections, teat duct openings were observed into the lactiferous cistern (Fig III.66).

Median (range) number of alveoli per lobule decreased as the *puerperium* progressed: it was 99 (31-250) in [L1+L2], 51 (24-121) in L3 and 10 (1-85) in L4. Difference for [L1+L2] versus L3 was significant ($P<0.001$), as was difference for [L1+L2] versus L4 ($P<0.001$) and L3 versus L4 ($P<0.001$); differences between all stages were also significant ($P<0.001$). Median (range) number of epithelial cells per alveolus also decreased as the *puerperium* progressed: it was 16 (5-35) in [L1+L2], 15 (6-35) in L3 and 7 (0-39) in L4. Difference for [L1+L2] versus L3 was significant ($P<0.001$), as was difference for [L1+L2] versus L4 ($P<0.001$) and L3 versus L4 ($P<0.001$); differences between all stages were also significant ($P=0.005$) (Table III.xxix).

Rc3 mammary glands had a significantly smaller number of alveoli than Rc1 ($P=0.035$) or Rc2 ($P=0.023$) mammary glands; no significant difference was evident between Rc2 and Rc1 ($P>0.5$) and between Rc2 and Lc2 ($P>0.8$) mammary glands. When stage of the *puerperium* was taken into account, differences in the number of alveoli between Rc3 and Rc1 / Rc2 were significant in [L1+L2] ($P=0.025$ and $P=0.005$, respectively) and in L3 ($P=0.044$ and $P=0.03$, respectively), but not in L4 ($P=0.150$ and $P=0.07$, respectively). No significant differences were evident between the number of epithelial cells per alveolus between Rc1, Rc2 and Rc3, nor between Rc2 and Lc2 mammary glands ($P>0.400$) (Table III.xxx).

Median (range) diameter of alveoli decreased significantly in L4: it was 44.6 μm (15.8-126.4) in L1 and L2, 45.1 μm (12.0-120.7) in L3 and 29.8 μm (10.6-74.8) in L4. Difference for [L1+L2] versus L3 was not significant ($P>0.4$), whilst difference for [L1+L2] versus L4 was significant ($P<0.001$) and difference for L3 versus L4 was also significant ($P<0.001$); differences between all stages were also significant ($P=0.035$). Median (range) height of epithelial cells also decreased significantly in L4: it was 8.7 μm (3.7-14.0) in [L1+L2], 9.2 μm (3.9-14.0) in L3 and 6.4 μm (3.3-11.6) μm in L4. Difference for [L1+L2] versus L3 was not significant ($P>0.5$), whilst difference for [L1+L2] versus L4 was significant ($P<0.001$) and difference for L3 versus L4 was also significant ($P<0.001$); differences between all stages were also significant ($P=0.044$) (Table III.xxxi).

Fig. III.61. Histological section of a mammary gland of a clinically healthy Beagle-breed female dog on D28 of the *puerperium*; presence of scant amount, similar to a narrow band, of connective tissue between the alveoli; fully developed alveoli with uniform epithelial cells; occasional presence of inflammatory cells in the inter-alveolar space (H&E, 40x objective, photograph taken on a Zeiss-Axiostar Microscope).

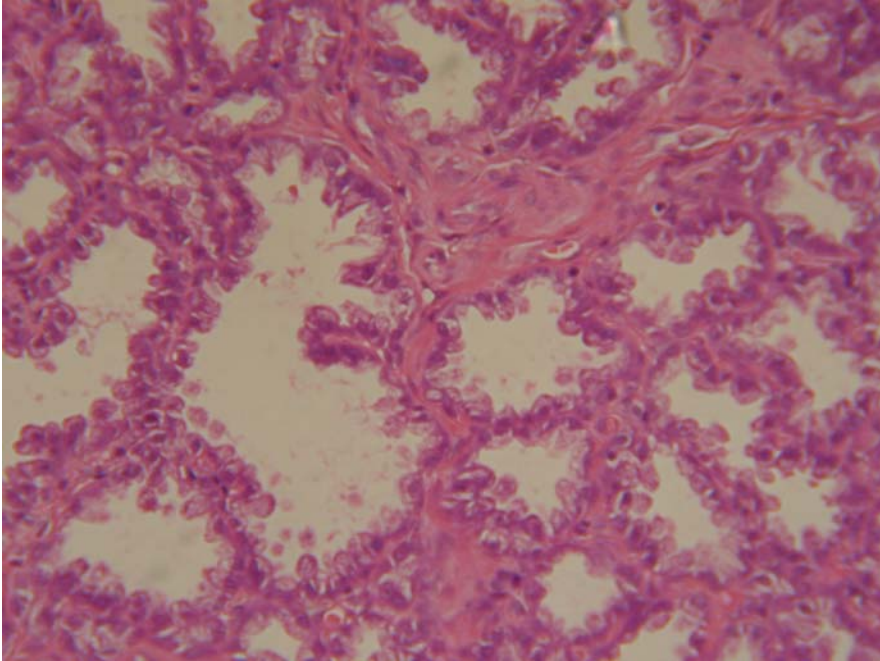

Fig. III.62. Ultrastructural profile of a mammary gland of a clinically healthy Beagle-breed female dog on D28 of the *puerperium*; fully developed alveolus surrounded by a myoepithelial cell, with uniform, cuboidal to slightly rectangular epithelial cells (SEM, 220x objective, photograph taken on a JEOL, JSM 840 scanning electron microscope).

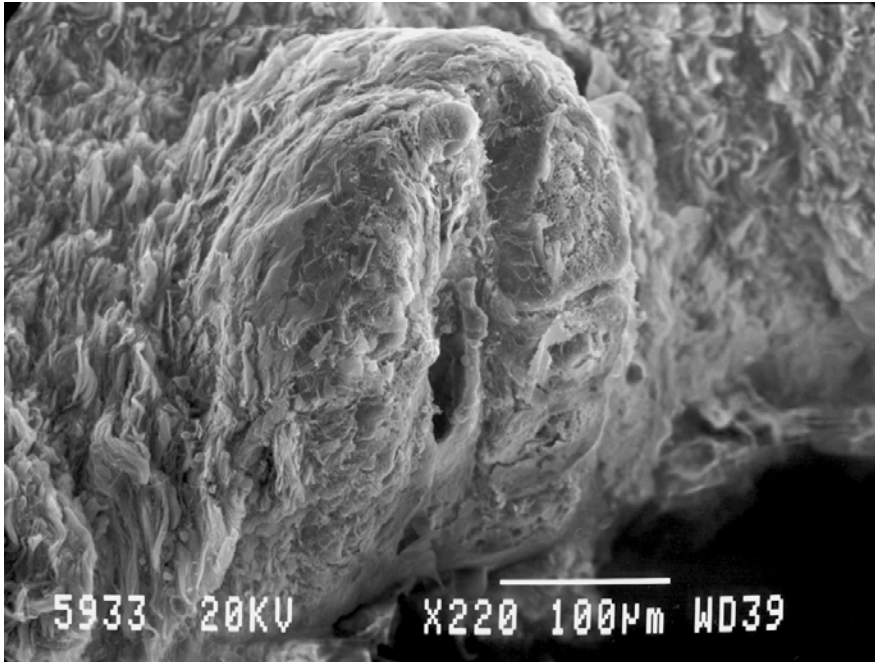

Fig. III.63. Ultrastructural profile of a mammary gland of a clinically healthy Beagle-breed female dog on D28 of the *puerperium*; fully developed alveolus surrounded by a myoepithelial cell, with uniform, cuboidal to slightly rectangular epithelial cells; evidence of a fat globule in the alveolar lumen (SEM, 1200x objective, photograph taken on a JEOL, JSM 840 scanning electron microscope).

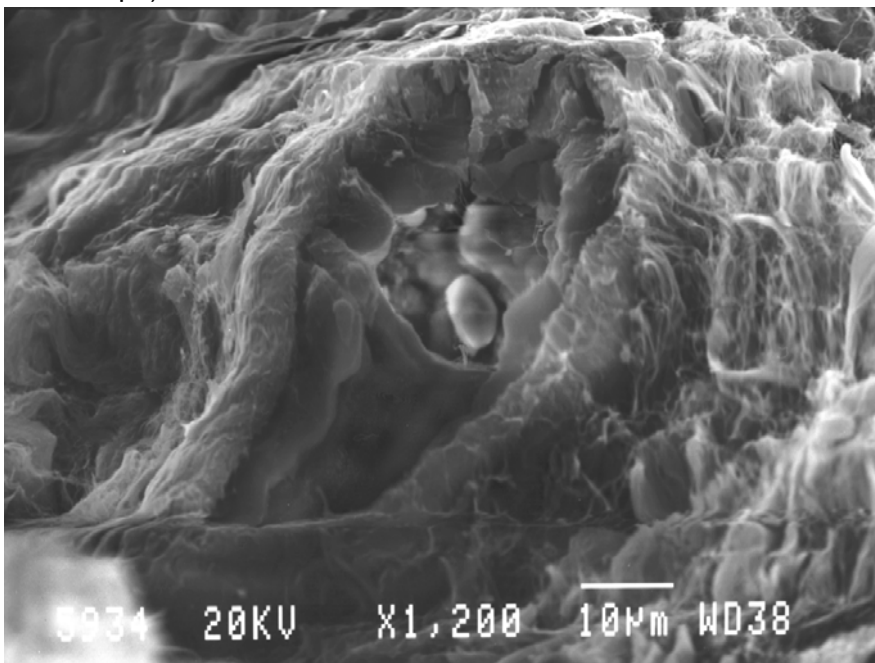

Fig. III.64. Histological section of a mammary gland of a clinically healthy Beagle-breed female dog on D84 of the *puerperium*; presence of abundant and dense connective tissue between the mammary lobules; shrunken and collapsed alveoli; presence of inflammatory cells in the inter-alveolar space (H&E, 10x objective, photograph taken on a Zeiss-Axiostar Microscope).

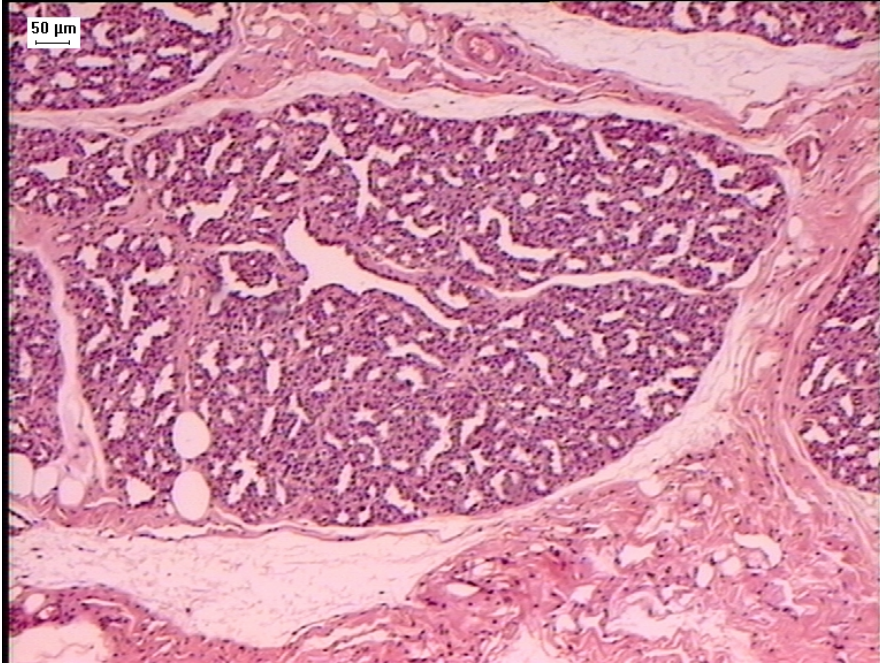

Fig. III.65. Ultrastructural profile of a mammary gland of a clinically healthy Beagle-breed female dog on D84 of the *puerperium*; shrunken and collapsed alveolus (SEM, 300x objective, photograph taken on a JEOL, JSM 840 scanning electron microscope).

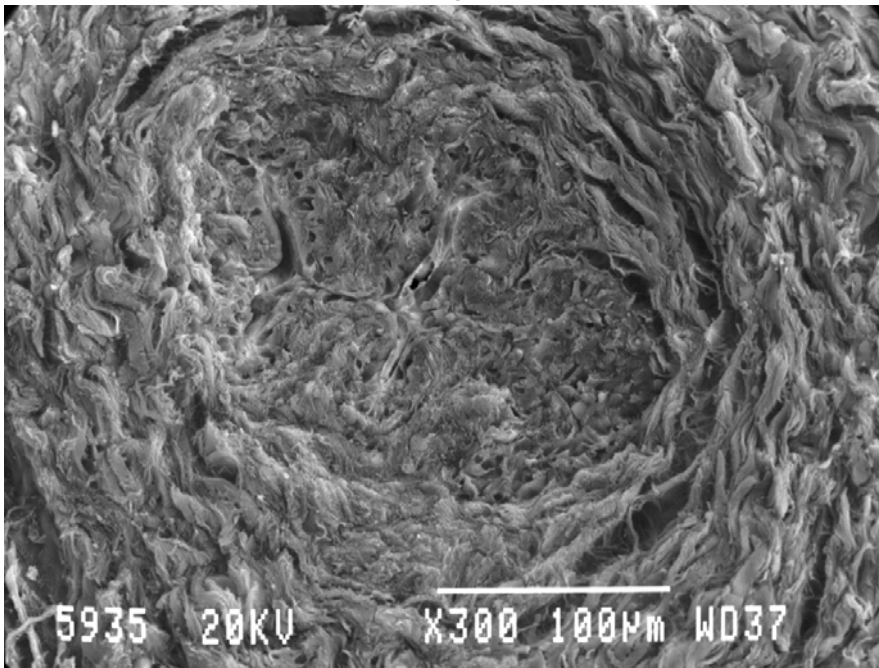

Fig. III.66. Ultrastructural profile of a mammary gland of a clinically healthy Beagle-breed female dog on D84 of the *puerperium*; lactiferous cistern with teat duct openings with a hair therein (SEM, 600x objective, photograph taken on a JEOL, JSM 840 scanning electron microscope).

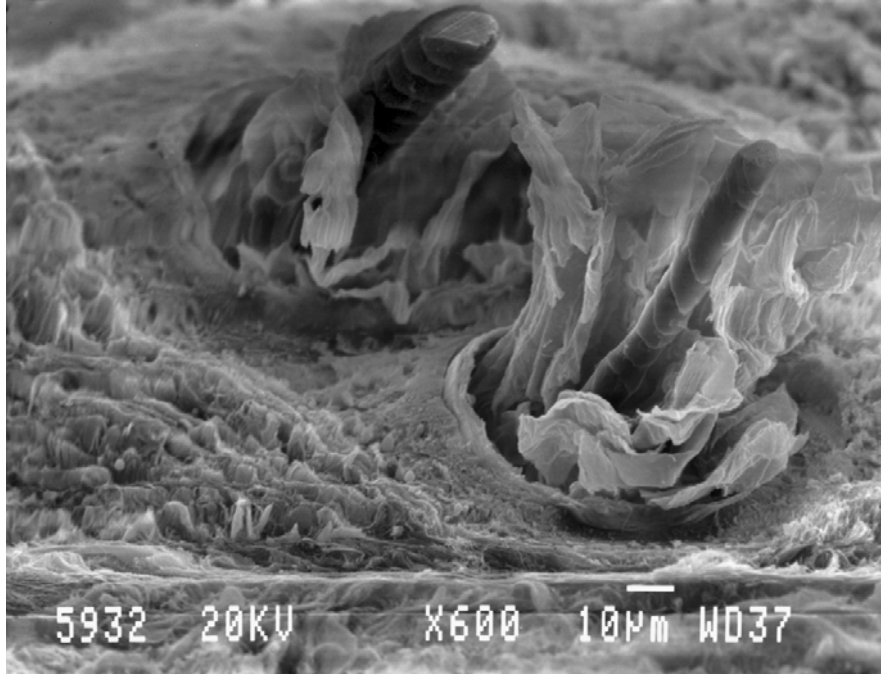

Table III.xxix. Median (range) numbers of alveoli per lobule and of epithelial cells per alveolus in the mammary glands of clinically healthy Beagle-breed female dogs during the *puerperium*.

Day after whelping	No. of alveoli per lobule	No. of epithelial cells per alveolus
4	137.5 (48-212) ^a	15 (6-30) ^a
7	126.5 (47-250) ^a	14 (5-35) ^a
10	99 (69-178) ^a	16 (9-31) ^a
14	92.5 (33-190) ^a	16 (9-30) ^a
21	74 (31-129) ^a	18 (11-34) ^a
28	51.5 (24-121) ^a	15 (9-35) ^a
35	60.5 (33-60) ^a	16 (9-27) ^a
42	43.5 (33-60) ^a	13 (6-23) ^a
56	24.5 (4-85) ^a	11 (5-39) ^a
70	7 (2-20) ^a	6 (2-20) ^a
84	8.5 (1-21) ^a	5 (0-16) ^a

a: progressive changes during the study $P < 0.05$.

Table III.xxx. Median (range) numbers of alveoli per lobule and of epithelial cells per alveolus in the mammary glands of clinically healthy Beagle-breed female dogs during the *puerperium*.

Mammary gland	No. of alveoli per lobule	No. of epithelial cells per alveolus
Rc1	56.5 (2-250) ^a	13.5 (2-39)
Rc2	60 (1-234) ^b	13 (0-35)
Rc3	47.5 (2-190) ^{a,b}	13 (0-26)
Lc2	65.5 (3-147)	14 (0-30)

Rc1: the caudal gland in the right side, Rc2 the gland cranially to Rc1, etc.; Lc2: the gland contralateral to Rc2.

Same superscripts within the same column indicate significant differences ($P < 0.05$) between respective values.

Table III.xxxi. Median (range) diametre of alveoli and of height of epithelial cells in the mammary glands of clinically healthy Beagle-breed female dogs during the *puerperium*.

Day after whelping	Diametre of alveoli (μm)	Height of epithelial cells (μm)
4	34.6 (17.6-61.3) ^a	7.1 (4.1-10.7) ^a
7	39.8 (18.2-72.3) ^a	8.2 (4.4-9.5) ^a
10	46.9 (15.8-91.4) ^a	9.0 (3.7-11.0) ^a
14	55.5 (34.8-99.3) ^a	9.7 (6.1-14.0) ^a
21	70.1 (21.2-126.4) ^a	8.2 (3.7-13.9) ^a
28	47.5 (12.0-107.9) ^a	9.6 (3.9-13.5) ^a
35	55.6 (28.2-120.7) ^a	9.2 (5.6-14.0) ^a
42	35.0 (22.3-63.4) ^a	7.2 (5.0-11.1) ^a
56	32.5 (16.4-74.8) ^a	6.9 (3.6-11.3) ^a
70	33.4 (10.6-71.0) ^a	6.5 (5.3-9.4) ^a
84	27.6 (14.6-61.3) ^a	6.4 (3.3-11.6) ^a

a: progressive changes during the study $P < 0.05$.

CHAPTER IV

GENERAL DISCUSSION

Introduction

During the *puerperium*, the genital tract returns to the pre-gavid state and prepares for the next pregnancy. In contrast, the mammary glands are fully functional and aim to fulfil the nutritional demands of the offspring.

There are marked differences between various animal species in the physiology of the genital system during the puerperium. For example, cows show ovarian rebound and reproductive activity soon after calving, with the target being, in current dairy cow management systems, to breed animals by day 60 after calving (Farin and Slenning 2001, Opsomer et al. 2002); ewes/does, which are seasonally breeding animals, may show oestrus depending on the season when lambing/kidding takes place (Bartlewski et al. 2011); sows in modern piggeries are expected to show ovarian activity and be mated or inseminated within 7 days after weaning of piglets (Soede et al. 2011). In contrast to the above, bitches show an 'anoestrus' period for up to six (or, occasionally, even to nine) months after whelping (Concannon 2011).

The present study aims to clarify aspects of and increase information regarding the physiological *puerperium* in Beagle-breed bitches. Moreover, the results of the study may provide reference data for the *post-partum* period in healthy dogs. Successful termination of pregnancy, as well as absence of clinical signs in the bitches and their puppies confirmed that the experimental animals were healthy during the study.

Haematological and blood biochemical values during pregnancy and the *puerperium*

Endocrinological changes during pregnancy and the *puerperium* lead to changes in metabolic pathways in animals, which would be reflected in altered haematological and blood biochemical values. For the study of these parameters, it was considered to include results obtained during pregnancy additionally to those obtained during the *puerperium*. It is believed that, in this way and only for these parameters, the extension of the time-period of work would benefit the main study, which is focussed in the *puerperium*. The establishment of a new 'reference' range of values for some of the parameters investigated can be taken into account when examining samples collected from bitches during the peri-parturient period, are examined.

The results indicate that, in female dogs, changes occur in values of some haematological and blood biochemical parameters during the peri-parturient period (last week of pregnancy and first week of the *puerperium*). Hence, use of established 'reference' values for these parameters may lead to erroneous conclusions. A different range of reference values for these parameters has been calculated and proposed; this may be used when testing blood samples from dogs in above reproductive stages.

In pregnancy, the haematological system undergoes changes to meet demands of developing foetuses and placentae, with alterations occurring in blood volume, constituent cells and coagulation factors (Carlin and Alfirevic 2008). Cavill (1995) suggested that anaemia observed at the end of pregnancy is the result of plasma volume increase and erythrocyte mass expansion (Clapp et al. 1988, Cavill 1995). Increased erythrocyte mass would contribute to meeting higher oxygen demands in pregnant animals. Reduced haematocrit at the end of pregnancy, as observed in this study, has also been reported before in dogs of various domestic breeds (Concannon et al. 1997, Gunzel-Apel et al. 1997), as well as in other mammalian species: women (Lurie 1993, Rao et al. 2004), doe rabbits (Cetin et al. 2009, Wells et al. 2009), rats (Kim et al. 2000), cows (Steinhardt and Thielscher 2009) and mares (Satue et al. 2010). In the immediate *post-partum* period, decreased haematocrit can be the consequence of haemorrhages taking place during erosion of uterine wall and vessels at placental removal during whelping.

Increased leucocyte counts were, primarily, the result of increased numbers of neutrophils; lymphocyte and monocyte numbers were also increased compared to other time-points during the monitoring period, but not to values greatly outside 'reference' ranges. Similar findings have been reported in pregnant women, where values up to 15,000 cells μL^{-1} are not uncommon, as a result of increased rate of marrow erythropoiesis (Peck and Arias 1979). Moreover, increased rate of thrombopoiesis, through increase in numbers and DNA content of megakaryocytes, takes place in late pregnancy and can lead to increased numbers of thrombocytes at that stage (Jackson et al. 1992). Increased leucocyte and thrombocyte counts at end of pregnancy and immediately after parturition have also been recorded in rats (Honda et al. 2009) and mares (Satue et al. 2010). Increased leucocyte counts at the end of pregnancy have previously been reported by Davies and Allen (1985) in one dog. In the present study increased leucocyte numbers were also evident in samples of uterine content or tissue; therefore, one may postulate that the increased blood leucocyte counts is the result of requirement for increased leucocytic infiltration in the uterus in the immediate *post-partum* period, which is discussed herebelow, acts prophylactically against uterine infections.

Decreased serum total protein and albumin concentration in the peri-parturient period has been recorded in women (Lind 1980), monkeys (Golub and Kaaekuahiwi 1997), doe rabbits (Mizoguchi et al. 2010) and rats (Papworth and Clubb 1995). There is a consensus that decreased albumin concentration in blood of individuals during pregnancy is the effect of increased foetal requirements, as well as of haemodilution occurring during pregnancy.

Significant changes in alkaline phosphatase activity during pregnancy and the *puerperium* may be due to changes in liver function or to endocrinological interactions or to increased osteoclastic activity of the female animal during pregnancy (Wells et al. 1999). However, although these changes during the peri-parturient period were significant, values remained within the 'reference' range.

Blood concentrations of C-reactive protein and fibrinogen (acute phase proteins) increased during 2nd and 3rd stage of pregnancy (subsequently to the first week of pregnancy). The findings confirm previous results (e.g., Evans and Anderton 1992, Eckersall et al. 1993, Gunzel-Apel et al. 1997, Bunck et al. 2001, Concannon et al. 2001), where these parameters were used as pregnancy indicators in dogs, as early as 21 days after mating. The decrease of blood concentrations of above parameters subsequently to whelping further supports that experimental animals were healthy during the study, as these parameters can be used for early indication of inflammatory processes (Solter et al. 1991).

Decreased calcium concentration reflects increased requirements at the final stage of pregnancy (due to increased mineralisation of foetal bones) and early *puerperium* (due to increased milk production). It is noteworthy that in cases of hypoproteinaemia (as observed in peri-parturient dogs in the present study), when the proportion of protein-bound calcium is reduced, the following formulae can be used for accurate calculation of calcium concentration: $CT_{Ca}=(T_{Ca}-T_{ALB})+4$ (Sodikoff 2001) or $CT_{Ca}=(T_{Ca}-[0,4\times T_{TP}])+3,3$ (Meuten et al. 1982) [CT_{Ca} : corrected total calcium concentration (mg dL⁻¹), T_{Ca} : calcium concentration (mg dL⁻¹), T_{ALB} : albumin concentration (g dL⁻¹), T_{TP} : total protein concentration (g dL⁻¹)]. If either of the above formulae was applied to adjust total calcium concentrations in animals into this study, also taking into account total protein / albumin concentration recorded at the same time-point in each animal, then calcium concentrations would be within the 'reference' range (Sodikoff 2001). As hypo-albuminaemia is evident in peri-parturient dogs, instead of making the above calculations, one could alternatively use a range of 8.8 to 9.9 mg dL⁻¹ for total calcium concentrations during that period.

Blood serum progesterone concentrations during the *puerperium*

Blood serum progesterone concentrations were found to be below the basal level of 1 ng mL⁻¹ (Concannon 2011). Concentrations during early *puerperium* (L1 and L2) were found to be increased compared to those during later stages (L3 and L4); this may be due to some, minimal, secretion of the hormone from residual foetal membranes or even from luteal tissue in the ovaries of the animals (which was observed in histological examination) during the former periods. In any case, the low blood serum progesterone concentrations indicate that the genital system was quiescent during the *puerperium*.

In previous reports, increased progesterone concentrations (>1 ng mL⁻¹) in bitches diagnosed with subinvolution of placental sites, were described (Al-Bassam et al. 1981a, b). In those reports, these increased values of progesterone concentration were recorded even after the 30th day *post-partum*.

Features of the genital system during the *puerperium*

Changes in the genital tract

Ultrasonographic examination was found useful to monitoring the course of uterine involution *post-partum*, as the findings coincided with the results of tissue examination after ovario-hysterectomy. Reduction in the number of layers observed ultrasonographically (from five layers initially to one or two layers later) and changes in echopattern of the uterine wall (which was imaged with a fine texture as the *puerperium* advanced) are compatible with findings of denser structuring of the uterine wall observed in histological sections. The five layers observed ultrasonographically at the early stages of the *puerperium* corresponded to the perimetrium, the outer muscular layer of myometrium, the vascular layer of the myometrium, the inner muscular layer of the myometrium and the endometrium, whilst at the final stages the two layers observed corresponded to the perimetrium and to a uniform myometrium-endometrium (Yeager and Concannon 1990). Reduction of the thickness of uterine wall observed in serial ultrasonograms was corroborated by the histometric results of reduction of the thickness of the myometrium.

Pharr and Post (1992) indicated that, in pathological conditions, failure to identify a reduction in the size of the uterus can be of diagnostic value. The present ultrasonographic findings can thus be used as reference data for imaging standards in bitches during the *puerperium*.

Echopattern findings in *post-partum* uterus of bitches have first been described by Yeager and Concannon (1990). The present results, allied to previous findings, can be of further value.

Placental sites and interplacental areas were easily differentiated in the ultrasonographic examination up to D35. Subsequently to that, their significant reduction in size, coupled with changes made necessary a longer time their differentiation during imaging, despite them being clearly distinguishable macroscopically (after ovario-hysterectomy) even on D84. This finding can also be of reference value in *post-partum* ultrasonographic examination of the uterus of female dogs.

Ultrasonographic examination of the ovaries during the *puerperium* appeared to be of limited value, due to the absence of specific features that characterize that period, as has been described before (Mattoon and Nyland 2002, Hetch 2008). In fact, in other publications it has been mentioned that it was difficult to locate and image ovaries of bitches after the first month of the *puerperium* (England and Allen 1989) or in the anoestrus in general (Fontbonne and Malandain 2006).

Noakes (2001) mentioned that almost equal numbers of *corpora lutea* (and subsequently *corpora albicantia*) could be observed on each ovary, as found in the present study. He also noted that the number of fetuses in each uterine horn differed from the numbers of corpora lutea in the respective ovary, because embryonic migration from one horn into the opposite appeared to be common; however, in the present study an almost equal distribution of *corpora albicantia* in the ovaries (41 in the left side, 38 in the right side) and placental sites in the uterine horn (41 in the left side, 39 in the right side).

Presence of trophoblast-like cells in smears from swabs from anterior part of the vagina and from uterine content, as well as in histological section of uterine tissue samples is worthy of a comment. Trophoblast-like cells are considered to be remnants from the basal part of the placenta (Al-Bassam et al. 1981b). Reberg and others (1992) suggested that identification of such cells in vaginal discharge of primiparous bitches is potentially indicative of subinvolution of placental sites. The present findings do not support that suggestion. Consistent presence of these cells in samples from all the animals, in the absence of any other accompanying features of the disorder (e.g., sanguineous or haemorrhagic vaginal discharge, increased blood serum progesterone concentrations, persistently increased size of the uterus during ultrasonographic examination and, especially, invasion of trophoblast-like cells into the myometrium, which is considered to be characteristic of the disorder [Al-Bassam et al. 1981a, b]), may indicate that these cells can be identified in animals with normally involuting uterus. Thus, it is proposed that their significance is re-assessed and their presence can be considered to be a normal feature. Perhaps also, the quantity

of such cells observed in samples from the animals, as well as other abnormal findings that might indicate subinvolution of placental sites, should be taken into account.

Presence of placental sites, even up to D84 *post-partum*, should be considered a normal feature of canine uterine involution, at least in primiparous bitches. There is also available evidence from field cases of post-parturient female dogs, of various ages, breeds and parities, in which ovario-hysterectomy was carried out at varying stages after whelping; those results do not form part of the present thesis, but are described only in brief. In total, 16 animals were operated; of these, 9 were two to four months in the *puerperium*, when operated. In 7 of these 9 animals, placental sites were evident during macroscopic examination of the uterus after the operation, in all cases coupled with blood serum progesterone concentrations $<1 \text{ ng } \mu\text{L}^{-1}$. These field findings lend further support to the above hypothesis and indicate that complete uterine involution may take over three months after whelping.

Finally, one may also suggest that length of the involution process can differ upon individual characteristics of the animals. In some animals, it may, normally, last longer than in others. Therefore, concepts about the length of *post-partum* involution of the genital system of bitches might need to be re-addressed. Specifically in primiparous animals, in which the genital system is at the gravid state for the first time, one may propose that involution could normally take longer than in multiparous bitches. As an example from other animal species, Short and others (1990) have mentioned that, in cows, primiparous animals in beef producing systems, which suckle their offspring, had longer *post-partum* interval than polyparous animals in the same conditions. Within this context, there may be a need for re-assessing suggestions by previous authors (Glenn 1968, Schall et al. 1971, Al-Bassam et al. 1981a) regarding development of subinvolution of placental sites in primiparous bitches, to consider a physiologically longer period of uterine involution in such animals.

Bacteriological and cytological characteristics in the genital system

The vaginal mucosa normally harbours bacterial populations. In fact, bacteria are isolated from the vagina of clinically healthy female dogs, more frequently during oestrus, but just as well, although less often, in anoestrus and dioestrus (Kustritz 2006). A variety of microorganisms has been isolated from samples from the vagina or the uterus of clinically healthy bitches *post-partum*; their majority has been identified as *Bacteroides*, *Escherichia coli*, *Pasteurella multocida*,

Staphylococcus spp. or *Streptococcus* spp. (Allen and Dagnall 1982, Baba et al. 1983, Gunzel-Apel et al. 1999, Munnich et al. 2000).

In the present study, it was found that median time to first infection after whelping was 0.25 days, which indicates that, very likely, bacterial entrance into the vagina followed expulsion of the fetuses at whelping; the frequent vaginal infections immediately *post-partum*, were reflected in the isolation of the same microorganisms from the uterine content of bitches operated on D4 and D7 only. However, bacteria may also enter into the vagina from faecal contamination (Bjurstrom and Linde-Forsberg 1992, Wiebe and Howard 2009); frequent isolation of *E. coli* in the present study lends support to this suggestion. Nevertheless, although 11/12 animals were found to be infected in L1, none developed metritis.

Bacterial antagonism may be a factor that may have contributed, as some of the organisms recovered (e.g., *Streptococcus* spp.) are confirmed part of the vaginal flora (Delucchi et al. 2008). Bacterial populations interact among themselves and constitute a 'community', where each species contributes to its stability. Many mechanisms by which bacteria and their interactions prevent the invasion and colonisation of pathogenic microorganisms have been proposed, but are not all fully understood. Occupation of the host's epithelial surfaces by bacterial flora and, thus, prevention of pathogen adherence on these cells (Bibel et al. 1983, Brook 2005) can be particularly important, given that adherence on epithelial cells by some microorganisms is necessary to express their pathogenicity. Alternatively, bacterial competition, which is the situation where two bacterial populations compete for multiplication and survival, usually resulting in cell population reduction or impeded growth rate, compared to when the two populations were separated (Isenberg and D'Amato 1985), may also be responsible. Finally, production of antagonistic substances by bacterial flora and competition for necessary nutritional substances between flora and invading organisms may also play a role (Smith 1995). For example, presence of *Streptococcus* spp. as part of the normal vaginal flora of bitches has been associated with reduced incidence of *post-partum* uterine infection (Delucchi et al. 2008).

Apart from its potential protective role, normal vaginal bacterial flora can also result, in cases of overgrowth, to uterine infection (Johnston et al. 2001); in previous studies, the same organisms were identified in samples from healthy female dogs and from bitches with reproductive disorders (VanDuijkeren 1992, Groppetti et al. 2012). This indicates that the bacterial flora can become pathogenic leading to development of clinical conditions. Various mechanisms (e.g., disruption of physical barriers to infection) have been identified as risk factors for development of endometritis by vaginal flora in cows (Potter et al. 2010).

Leucocytes, increased numbers of which were found subepithelially in *post-partum* uterine tissue samples, act to protect the organ, as extensively documented in other animal species (Noakes 2001). Presence of leucocytes in the anterior vaginal swab and uterine content samples might be the effect of clearance from the uterine tissue. These cells constituted the majority of cells observed in smears from these sites, although their proportion progressively decreased (coinciding with reduction of leucocyte numbers observed in the uterine epithelium in tissue samples). Progressively, number of leucocytes in vaginal smears reduced, coinciding with the reduction in frequency of bacterial isolation from the same sites, which further indicates their protective role in the uterus of post-parturient bitches. The cytological results corroborate those of Watts and others (1998), but are in direct contrast to the results of Gunzel-Apel and others (1999), who mentioned that >70% of the cells in smears from those sites were epithelial cells. The reason for this discrepancy with the latter report is unclear.

Features of the mammary glands during the *puerperium*

Changes in the mammary glands

Findings of ultrasonographic examination were not as striking as those of the uterus. This is not surprising, as, for the longer part of the *puerperium*, the mammary glands are fully functional, in contrast to the involuting genital tract. Nevertheless, even when mammary involution started (in L4), changes observed in the mammary glands during imaging were still mild.

The present ultrasonographic findings may also be used as reference data for imaging standards in bitches during the *puerperium*. Ultrasonographic findings in canine mastitis are conflicting; Ververidis and others (2006) mentioned that ultrasonographic findings in subclinical mastitis did not contribute to the diagnosis of the disease, whilst Trasch and others (2007) described the ultrasonographic findings in a dog with mastitis. Hence, the present results can be of value.

The findings of the behavioural observations provide clear evidence that the caudal mammary glands of female dogs are preferred for sucking by puppies over the cranial ones, perhaps because the former glands produce more milk. The results of the study lend support to this hypothesis, as the number of alveoli present per lobule in Rc3 mammary glands was smaller than in Rc1 and Rc2 mammary glands. The increased size of the two most caudal glands recorded in the anatomical observations (which are in agreement with previously published results [Evans and

Christensen 1993]) is reflected in the increased number of alveoli in these glands. The number of alveoli (and tissue in general) in a mammary gland is directly related to the amount of milk produced (Tucker 1981, Knight and Peaker 1982, Nielsen et al. 2001), although other factors (e.g., intramammary pressure [Hartmann et al. 1997]) can also exert some influence on the amount of milk produced. Thus, the greater number of alveoli would lead in increased milk production by those mammary glands. Break-down and analysis of results by stage of the *puerperium* indicates that this difference was more intensified in the immediately *post-partum* period (i.e., when the mammary glands are fully functional and the newborn puppies rely most on maternal milk for survival and growth). These findings are in direct contrast to observations in sows, where the cranial mammary glands have been found to produce more milk than the caudal ones (Nielsen et al. 2001, Skok et al. 2007).

Hence, it can be suggested that decreased milk production by Rc3 mammary gland would eventually result in earlier involution of this mammary gland. As the requirements of growing puppies increase, milk production of Rc3 gland cannot satisfy their needs; thus, puppies would progressively abandon sucking that mammary gland. This may appear a simplified approach, but similar findings have been repeatedly reported with lambs (Nowak 1996, Gougoulis, Kyriazakis, Papaioannou et al. 2008) and calves (Selman et al. 1970, Krohn 2001). Therefore, the Rc3 likely involuted earlier than the other glands; this hypothesis is supported by the gross anatomical findings in samples from the dog operated on D56 of the *puerperium*.

Thereafter, involution was evident in all mammary glands of an animal. The results suggest that in female dogs, involution of the mammary glands starts around the end of the 2nd month after whelping. By the end of the 3rd month after whelping (in cases the dam is still suckling puppies), the process is almost complete, as corroborated by the results of histological observations and histometric examinations, which showed progressive significant decrease of numbers of mammary elements. Behavioural observations have shown that bitches suckle their puppies for 10 (Rheingold 1963) to 12 (present results) weeks *post-partum*.

Defences of the canine mammary gland have not been studied as extensively as those of ruminants. Presence of inflammatory cells in mammary tissue indicates that cellular defences are important for mammary defence, which is shown in the absence of bacterial isolation from mammary tissue samples. As in ruminants, macrophages and lymphocytes were the predominant cells in the mammary glands of female dogs; these constitute the resident cell population in mucosae. Furthermore, increased intra-alveolar presence of inflammatory cells in late lactation participates in removal of fat globules or protein micelles and contributes to the normal process of

mammary involution (Lee and Lascelles, 1970). These findings further support the hypotheses that mammary involution in female dogs starts at around the end of the 2nd month after whelping.

Bacteriological and cytological characteristics in the mammary glands

There is very little information regarding characteristics of milk of healthy female dogs. However, diseases of the mammary glands of these species are of significant concern, because of the welfare consequences for the sick animals, as well as because they affect nutrition of the puppies. The results indicate that mammary infections in bitches (as shown by bacterial isolation from respective milk samples) occur occasionally during lactation, but do not always result to mastitis.

During the study, it was found that risk of bacterial infection of more caudal mammary glands of the bitches was increased compared to that of more cranial glands. One may suggest that this reflects the anatomical position of these glands, which puts them at increased risk of infection (e.g., from faeces), although no association was found with vaginal infections. Moreover, increased sucking activity in the caudal glands, as recorded during the behavioural observations, can also be another risk factor for infection. Indeed, in ewes (Fragkou et al. 2011) and sows (Kemper and Preissler 2011), sucking has been shown to contribute to infection of the mammary glands. The fact that first infection of caudal glands occurred earlier than that of others (3 days *versus* >7 days after whelping, respectively) lends further support to the above arguments.

Subsequently to bacterial infection, increased quantity of milk in the caudal glands could have contributed to bacterial multiplication therein, which has accounted for the higher number of persistent infections in those glands. However, in all cases, efficiency of mammary defences prevented development of disease.

In detailed studies of the bacterial flora in the teat duct of ewes, an increased risk for infection of the teat duct compared to the mammary gland has been documented (Mavrogianni et al. 2007); it was then shown that defence mechanisms in the teat (Mavrogianni et al. 2005, Fragkou et al. 2007) can limit bacterial invasion towards the mammary gland. Lack of a similar pattern in infection rates in bitches can be the consequence of canine teats having many ducts, through which bacteria may enter into the mammary gland, whilst, in the present study, only one teat duct was sampled. However, when infection of that duct was recorded, no concurrent infection of the parenchyma was always evident; this can suggest that the teat duct may play a protective role for the mammary gland in bitches.

No association was found between increased number of teat orifices and cases of infections in respective mammary glands, although this would have appeared reasonable, as teat orifices provide portals of entry for invading microorganisms. Although no specific studies have been undertaken, perhaps ducts in canine teats with smaller number of ducts are wider than those in teats with greater number of ducts. Plommet (1960) has described that increased diameter of teat ducts as a risk factor for mastitis in ruminants.

Although previous studies have referred to metritis as a potential factor for mastitis in bitches (Linde-Forsberg 2005), the results of the present study did not show such an association. In a study into porcine mastitis, no association between mastitis and metritis was found, but only with presence of vaginal discharge, which was erroneously attributed to have been caused by metritis (Mendizabel 1975).

The majority of organisms isolated from milk or duct material samples were identified as *Staphylococcus pseudintermedius* (45% and 41% of isolates, respectively) or other staphylococci. These organisms are part of the canine skin flora (Saijonmaa-Koulumies and Loyd 1996, Fazakerley et al. 2010), this possibly being the source of infection for the teat duct and the mammary gland, as already reported in cows (Barkema et al. 2009, Capurro et al. 2010) and ewes (Marco Melero 1994). The organism is a confirmed mammary pathogen for female dogs (Kuhn et al. 1991, Ververidis, Mavrogianni et al. 2007).

The significant association of Whiteside test scores with bacteriologically positive results in milk samples is noteworthy. Present results, allied to those by Ververidis, Mavrogianni and others (2007), who also pointed out to a strong association of the test's results with bacteriological findings from cases of confirmed staphylococcal mastitis, indicate the usefulness of the test for rapid detection of subclinical mastitis. Suspicion of the disorder, which does not have any clinical features, can arise only in cases of suboptimal growth of puppies (Schäfer-Somi et al. 2003); therefore, use of the test, followed by microbiological examination of milk samples, may be useful in its diagnosis.

Significantly increased Whiteside test scores in L1 correlate with the increased frequency of infection during that period; increased leucocyte numbers indicate efficient mammary defences, which have averted development of clinical mastitis. Wheeler and others (1984) and Biddle and Macintire (2000) mentioned that mastitis in bitches is more frequent during the first 7 to 10 days *post-partum* and Linde-Forsberg and Eneroth (1998) associated development of clinical mastitis immediately *post-partum* with inappropriate management of bitches. Perhaps, development of clinical mastitis can be the combined result of increased mammary infections immediately after whelping coupled with ineffective cellular mammary defences against invading organisms, perhaps

as the result of incorrect management of dogs and their litters. Other factors, none of which applied in this study, may also contribute to development of clinical disease (e.g., damaged teats [Johnston et al. 2001] or unclean environment [Linde-Forsberg and Eneroth 1998]).

In contrast, significantly increased cellular content at the end of lactation, as indicated by increased Whiteside test scores, coupled with a reduced risk of bacterial infection, could be a 'dilution-effect', as milk production progressively decreases. Similar findings have already been reported in milk of cows, ewes and does (Hurley 1989, Raynal-Ljutovac et al. 2007).

Proportion of leucocyte types recorded in milk samples was similar to that recorded in mammary tissue samples. As mentioned above, these leucocytes appear to play an active defence role within the mammary gland, as no clinical cases of mastitis were recorded during the study. Moreover, when concurrent microbiological isolation and increased Whiteside test scores were evident, these were resolved with no other adverse consequences.

Patterns of maternal - offspring behaviour during the *puerperium*

No negative maternal behaviours were observed in bitches. Such behaviours are considered to be consequences of placement in unknown environment, a difficult whelping procedure or annoyance of post-parturient animals by humans (Houpt 2000; Linde-Forsberg 2005).

Protective behaviours of bitches to puppies was found to decrease progressively, as already reported by Pal (2005), who investigated canine maternal behaviour in free-ranging dogs. However, contact time with puppies (behaviours 'Lying in contact with puppies', 'Grooming puppy', 'Protecting puppies') was less than that reported by that author. Bitches can remain with their puppies for 10 to 13 weeks, although interaction with puppies progressively decreased (Macdonald and Carr 1995, Pal 2005). Although a direct comparison of the results is not possible, likely the difference was the result of animals in the present study being protected from adverse external stimuli, as they were continuously housed, given that housing conditions of dogs have been found to affect their behaviour (Hetts et al. 1992).

Increased mobility of the bitches with advancement of the *puerperium* likely indicates that the puppies become less dependent of their dams (e.g., feeding by solid feed), hence the female animals feel that they can spend more time away from their offspring. However, a potential nuisance effect may not be ruled out.

Social behaviour of puppies ('Inside whelping box', 'Outside whelping box', 'Playing') started after the 3rd week of life and, progressively, increased. Serpell and Jagoe (1995) referred

to the 2nd and 3rd month of life of puppies as a 'sensitive period' for development of social behaviour of young animals, during which puppies learn and develop dominant, submissive and agonistic behaviours. Moreover, playing contributes to development and maintenance of social abilities; newborns learn about social bonds, acquire motor abilities, accumulate new information about the environment and, even, attain sexual behaviour, as has been documented in apes (Biben 1998, Lewis et al. 2005, Palagi 2007) and dogs (Bauer and Smuts 2007, Ward et al. 2009). Spinka and others (2001) have indicated the importance of within-litter play for the social and cognitive development of young animals, as well as for their training to cope for unexpected circumstances in future life. However, one can postulate that, perhaps, the decrease of 'Playing' activity after the 63rd day of life occurred, because the puppies had already accumulated as much information as possible from their environment. Even in free-ranging dogs (i.e., in which continuous uptake of new cognitive stimuli is possible) playing activity was decreased during the 3rd month of life (Pal 2010).

The 'ritual' of feeding puppies by regurgitation of partially digested feed, observed in wild canids (Kleiman and Eisenberg 1973, Ewer 1998), as well as in free-ranging dogs (Pal 2005), was not observed in this study. The most likely reason for this discrepancy is that the experimental animals were offered commercially-prepared feed, suitable for their specific needs. Moreover, provision of feed was regular and at standard feeding times daily. The behaviour of feeding puppies by regurgitated feed helps to nourish puppies with partially digested meat, which has been hunted, in animals living in the wild or free-ranging conditions. Therefore, it does not seem to be of value in housed dogs, in which animals cover of nutritional requirements is controlled.

In the past, ethological studies were, in their majority, aiming to address social and/or production issues in animals. Potential association of such studies with the health of the subjects had been largely ignored. Nevertheless, abnormal behaviours can indicate health problems (Ewbank 1985, Gougoulis et al. 2010); conversely, standard normal behaviours of animals may contribute to development of health problems. In this study, the increased frequency of sucking of caudal mammary glands of bitches was associated with increased infection risk of these glands.

S. pseudintermedius has been recovered from the mouth of young puppies (Saijonmaa-Koulumies and Loyd 2002). When the teat is inside the mouth of the puppy (during sucking), the organism may be attached on the teat, subsequently entering into the duct. Moreover, searching teat and sucking attempts by puppies, as shown in the behavioural observations, during which a puppy investigates the inguinal or abdominal area of the dam and licks around, as well as when it has the teat into the mouth may contribute to uptake of *S. pseudintermedius*, which are confirmed bacterial flora of canine skin (Saijonmaa-Koulumies and Loyd 1996, Fazakerley et al. 2010), into

the mouth. Then, the tongue of the puppy may 'push' the bacteria upwards into the duct. Finally, bacterial teat duct flora, found in the bacteriological investigation, may also be pushed upwards during the sucking by a puppy. In fact, in sheep, transfer of bacteria to the teat duct during sucking has been documented by Gougoulis, Kyriazakis, Tzora and others (2008) and Fragkou and others (2011).

Effects of litter size on the characteristics of the *puerperium*

The following characteristics were found to differ between animals in large or small litters: bodyweight of bitches, bodyweight of puppies, dimensions of external genitalia and some behavioural parameters.

Bodyweight and growth of puppies is dependent on their bodyweight at birth and on feed consumed, especially milk, during the first weeks of life. In pigs (another animal species with large litters), it is well documented that piglets born in large litters have a decreased bodyweight at birth (Dourmad et al. 1999, King et al. 1999), just as found in the puppies born in large litters. These animals have a subsequently increased relative body growth, but piglets born in small litters still maintain a higher bodyweight at weaning (King et al. 1999, McGlone and Pond 2002); although effects of birth weight increase with increasing age, piglets born with larger bodyweight maintain that until slaughter (King et al. 1999). It appears that similar principles apply in puppies, hence animals born in large litters had smaller weight than ones born in small litters and maintained that significant difference throughout the study.

The increased dimensions of the vulva observed in bitches with large litters may be the consequence of a longer time to complete the process of whelping, as well as to a cumulative effect of repeated expulsions of newborns on the peri-genital tissues.

In general, behavioural observations did not reveal differences between animals with/in large or small litters. Significantly increased mobility (in and out of the whelping box) of bitches with large litters may be the consequence of some annoyance of these animals by their newborns; exit from the whelping box allowed them a period of rest, especially during L4, where mammary involution made difficult, perhaps even painful, sucking by an increased number of puppies. In contrast, the significantly increased mobility (in and out of the whelping box) was recorded in puppies in small litters may be the consequence of these animals being stronger and moving more steadily, as they grew better with a higher bodyweight.

Epilogue

Conclusions

The conclusions from the results of the present thesis are summarised herebelow.

(a) 'Reference' values for haematological and blood biochemical values are proposed for samples collected from bitches during the peri-parturient period. New 'reference' values are proposed for haematocrit, leucocyte counts, thrombocyte counts, haemoglobin concentration, mature neutrophil counts, lymphocyte counts, total protein concentration, albumin concentration and C-reactive protein concentration.

(b) The present ultrasonographic findings of the uterus and the mammary glands can be used as further reference data for imaging standards in bitches during the *puerperium*.

(c) Current concepts about the length of *post-partum* involution of the genital system of bitches might need to be re-addressed.

- In primiparous animals, one may propose that involution could normally take longer than in multiparous bitches.
- The significance of 'foamy' cells in the uterus could be re-assessed and their presence could be considered as a normal feature. Perhaps, the quantity of such cells observed in samples from the animals, as well as other abnormal findings that might indicate subinvolution of placental sites, should be taken into account.

(d) Despite a very high infection rate of the genital system in the immediately *post-partum* period, effective cellular (neutrophils) defences of the animal contribute to protection from development of metritis.

(e) Involution of the mammary glands starts around the end of the 2nd month after whelping. By the end of the 3rd month after whelping (in cases the dam is still suckling puppies), the process is almost complete.

(f) Staphylococci are the primary bacteria isolated from milk samples of healthy female dogs during lactation.

- The organisms likely originate from the skin of the animal.
- Infection risk of the caudal mammary glands is increased compared to that of the cranial glands.
- Infection risk during the early *post-partum* period is increased compared to that in later stages.

(g) Macrophages and lymphocytes constitute the main cells present in mammary glands.

- The Whiteside test appears to be useful for detecting increased cellular content in the milk of female dogs.

(h) Ethological observations indicate an association of normal behaviour with potential health problems.

- Sucking is a factor contributing to the increased infection risk of the caudal glands and of the early *post-partum* period.
- No adverse behaviours were observed in the dams.
- In general, litter size did not affect behaviours of female animals and their puppies.

Prospects

Suggestions for further research, in continuation of the present work, are as below.

- The study of uterine involution in secundiparous and multiparous female dogs.
- The evaluation of ultrasonographic features in various disorders of the uterus and the mammary glands, in comparison to the standards established in this study.
- Molecular identification studies of bacterial isolates from the intestine, the skin, the genital tract (vagina and uterus) and the milk of bitches, as well as from the mouth and the nasopharynx of puppies to establish similarities and differences between strains.
- Studies in the cellular content of the milk of female dogs.
- Behavioural studies to include various parameters in the environment of the dogs, with a view to establish potential associations with health issues.
- Effects of sex of puppies in their behaviour.

REFERENCES

- Agriolas A, Gessa GL (1991). Central function of oxytocin. *Neuroscience & Biobehavioral Reviews* 15:217-231.
- Al-Bassam MA, Thomson RG, O'Donnell L (1981a). Involution abnormalities in the postpartum uterus of the bitch. *Veterinary Pathology* 18:208-218.
- Al-Bassam MA, Thomson BG, O'Donnell L (1981b). Normal postpartum involution of the uterus in the dog. *Canadian Journal of Comparative Medicine* 45:217-232.
- Allen WE, Dagnall GJR (1982). Some observations on the aerobic bacterial flora of the genital tract of the dog and bitch. *British Veterinary Journal* 23:325-335.
- Andersen AC, Simpson ME (1973). *The Ovary and the Reproductive Cycle of the Dog (Beagle)*. Geron-X, Inc, Los Altos, California, 290 pp.
- Arbeiter K, Dickie MB (1993). Possible consequences of SIPS on the fertility of the bitch. *Tierärztliche Umschau* 48:420-422.
- Austad R, Bjerkas E (1976). Eclampsia in the bitch. *Journal of Small Animal Practice* 17:793-798.
- Baba E, Hata H, Fukata T, Arakawa A (1983). A vaginal and uterine microflora of adult dogs. *American Journal of Veterinary Research*, 44:606-609.
- Banks WJ (1993). *Applied Veterinary Histology*, 3rd edn. Mosby, USA, 527 pp.
- Barkema HW, Green MJ, Bradley AJ, Zadoks RN (2009). The role of contagious disease in udder health. *Journal of Dairy Science* 92:4717-4729.
- Barone R (2001). *Anatomie Comparée des Mammifères Domestiques. Tome 4: Splachnologie II Appareil Uro-génital, Foetus et ses Annexes, Péritoine et Topographie Abdominal*, 3rd edn. Vigot, 896 pp.
- Barrow GI, Feltham RKA (1993). *Manual for the Identification of Medical Bacteria*, 3rd edn. Cambridge University Press, Cambridge, 352 pp.
- Bartlewski PM, Baby TE, Giffin JL (2011). Reproductive cycles in sheep. *Animal Reproduction Science* 124:259-268.
- Bastan A, Findik M, Erunal N, Aslan S, Kilicoglu C (1998). The use of cabergoline for treatment of pseudopregnancy in dogs with the purpose of suppressing lactation. *Reproduction in domestic Animal* 33:49-53.
- Bauer EB, Smuts BB (2007). Cooperation and competition during dyadic play in domestic dogs, *Canis familiaris*. *Animal Behaviour* 73:489-499.
- Biddle DW, Macintire DK (2000). Obstetrical emergencies. *Clinical Techniques in small Animal Practice* 15:88-93.

- Bibel DJ, Aly R, Bayles C, Strauss WG, Shinefield HR, Maibach HI (1983). Competitive adherence as a mechanism of bacteria interference. *Canadian Journal of Microbiology* 29:700-703.
- Biben M (1998). Squirrel monkey play-fighting: making the case for a cognitive training function for play. In: M Bekoff, JA Byers (eds) *Animal Play: Evolutionary, Comparative, and Ecological Perspectives*, Cambridge University Press, Cambridge, pp. 161-182.
- Bjurstrom L, Linde-Forsberg C (1992). Long-term study of aerobic bacteria of the genital tract in breeding bitches. *American Journal of Veterinary Research* 53:665-669.
- Boscov C, Samartzi F (1996). Post-partum disorders in the bitch [in greek with English abstract] *Bulletin of Hellenic Veterinary Medical Society* 46:342-351.
- Brook I (2005). The role of anaerobic bacteria in tonsillitis. *International Journal of Pediatric Otorhinolaryngology* 69:9-19.
- Bunck CK, Mischke R, Gunzel-Apel AR (2001). Investigation of the fibrinolytic system during nonpregnant and pregnant oestrous cycles of bitches. *Journal of Reproduction and Fertility* 57(Suppl):207-214.
- Burke TJ (1977). Post parturient problems in the bitch. *Veterinary Clinics of North America* 7:693-698.
- Bush BM (1993). *Interpretation of Laboratory Results for Small Animal Clinicians*. Blackwell, Oxford, 515 pp.
- Capen CC (2004). Metabolic disorders of calcium-phosphorus homeostasis. In: RH Dunlop, CH Malbert (eds) *Veterinary Pathophysiology*, Blackwell, Ames, pp. 422-444.
- Capurro A, Aspán A, Ericsson Unnerstad H, Persson Waller K, Arthursson K (2010). Identification of potential sources of *Staphylococcus aureus* in herds with mastitis problems. *Journal of Dairy Science* 93:180-191.
- Carlin A, Alfirevic Z (2008). Physiological changes of pregnancy and monitoring. *Best Practice & Research Clinical Obstetrics & Gynaecology* 22:801-823.
- Carter CS (1992). Oxytocin and sexual behaviour. *Neuroscience and Behavioral Physiology* 16:131-144.
- Cavill I (1995). Iron and erythropoiesis in normal subjects and in pregnancy. *Journal of Perinatal Medicine* 21:1-24.
- Ceron JJ, Eckersall PD, Martinez-Subiela S (2005). Acute phase proteins in dogs and cats: current knowledge and future perspectives. *Veterinary Clinical Pathology* 34:85-99.

- Cetin N, Bekyurek T, Cetin E (2009). Effects of sex, pregnancy and season on some haematological and biochemical blood values in Angora rabbits. *Scandinavian Journal of Laboratory Animal Science* 36:155-162.
- Christensen GC (1979). The integument. In: Evans HE, Christensen GC (eds) *Miller's Anatomy of the Dog*, 2nd edn. Saunders, Philadelphia, pp. 78-106.
- Clapp JF 3rd, Seaward BL, Sleamaker RH (1988). Maternal physiologic adaptations to early human pregnancy. *American Journal of Obstetrics and Gynecology* 159:1456-1460.
- Colville T (2002). The reproductive system. In: T Colville, JM Bassert (eds) *Clinical Anatomy and Physiology for Veterinary Technicians*, Mosby, USA, pp. 318-343.
- Concannon PW (2011). Reproductive cycles of the domestic bitch. *Animal Reproduction Science* 124:200-210.
- Concannon PW, Butler WR, Hansel W, Knight PJ, Hamilton JM (1978). Parturition and lactation in the bitch: serum progesterone, cortisol and prolactin. *Biology of Reproduction* 19:1113-1118.
- Concannon P, Lasley B, Vanderlip S (1997). LH release, induction of oestrus and fertile ovulations in response to pulsatile administration of GnRH to anoestrous dogs. *Journal of Reproduction and Fertility* 51(Suppl):41-54.
- Concannon P, Tsutsui T, Shille V (2001). Embryo development, hormonal requirements and maternal responses during canine pregnancy. *Journal of Reproduction and Fertility* 57(Suppl):169-179.
- Dascanio JJ, Mechor GD, Grohn YT, Kenney DG, Booker CA, Thompson P, Chiffelle CL, Musser JMM, Warnick LD (1995). Effect of phenylbutazone and flunixin meglumine on acute toxic mastitis in dairy cows. *American Journal of veterinary Research* 56:1213-1218.
- Davidson A (2003). Disorders of puerperium and lactation. In: *Pathology of Canine and Feline Reproduction, Physiology and Pathology of the Neonate*, vol. 2, School of Veterinary Medicine, Hannover, pp 14.1-14.6.
- Davies JV, Allen WE (1985). Leucocytocis during normal pregnancy in a bitch. *Veterinary Record* 116:412-413.
- Debraeckeeler J, Gross KL, Zicker SC (2000). Normal dogs. In: MS Hand, CD Thatcher, RL Remillard, P Roudenbush (eds) *Small Animal Clinical Nutrition*, 4th edn. Walsworth Publishing Company, USA, pp. 232-250.
- Delucchi L, Fraga M, Perelmutter K, Cidade E, Zunino P (2008). Vaginal lactic acid bacteria in healthy and ill bitches and evaluation of in vitro probiotic activity of selected isolates. *Canadian veterinary Journal* 49:991-994.

- Dernell WS, Kreeger J (1992). Peracute necrotizing mastitis as a cause of fatal septicemia and endotoxemia in a dog. *Canine Practice* 17:25-29.
- Dickie MB, Arbeiter K (1993). Diagnosis and therapy of the subinvolution of placental sites in the bitch. *Journal of Reproduction and Fertility* 47(Suppl):471-475.
- Dourmad JH, Noblet J, Pere MC, Etienne M (1999). Mating, pregnancy and prenatal growth. In: I Kyriazakis (ed.) *A Quantitative Biology of the Pig*, CABI Publishing, Oxford, pp. 129-153.
- Drobatz KJ, Casey KK (2000). Eclampsia in dogs: 31 cases (1995-1998). *Journal of American Veterinary Medical Association* 217:216-219.
- Dyce KM, Sack WO, Wensing CJG (1996). *Textbook of Veterinary Anatomy*, 2nd edn. Saunders, Philadelphia.
- Dzieciol M, Stefaniak T, Twardon J, Kozdrowski R (2006). Chosen parameters of the milk and blood of bitches with healthy mammary glands and those suffering from mastitis. *Medycyna Weterynaryjna* 62:59-61.
- Eckersall PD, Harvey MGA, Ferguson JM, Renton JP, Nickson GA, Boyd JS (1993). Acute phase proteins in canine pregnancy (*Canis familiaris*). *Journal of Reproduction and Fertility* 47(Suppl.):159-164.
- England GCV (1998). Dystocia and post-partum problems. In: Jb Sutton, ST Swift (eds) *Allen's Fertility and Obstetrics in the Dog*, Blackwell, London. pp. 147-156.
- England GCV (2001). Genital surgery in the bitch and queen cat. In: DE Noakes, TJ Parkinson, GCW England (eds) *Arthur's Veterinary Reproduction and Obstetrics*, 8th edn, Saunders, Edinburgh, pp. 374-379.
- England GCV, Allen WE (1989). Real-time ultrasonic imaging of the ovary and uterus of the dog. *Journal of Reproduction and Fertility* 39(Suppl.):91-100.
- England G, Yeager A, Concannon PW (2003). Ultrasound imaging of the reproductive tract of the bitch. In: *Recent Advances in Small Animal Reproduction*, IVIS, Ithaca.
- Euzeby JP (1997). List of bacterial names with standing in nomenclature: a folder available on the internet. *International Journal of Systematic Bacteriology* 47:590-592.
- Evans JM, Anderton DJ (1992). Pregnancy diagnosis in the bitch: the development of a test based on the measurement of acute phase proteins in the blood. *Annales de Zootechnie* 41:397-405.
- Evans HE, Christensen GC (1993). The urogenital system. In: HE Evans (ed) *Miller's Anatomy of the Dog*, 3rd edn. Saunders, Philadelphia, pp. 549-555.

- Ewbank R (1985). Contribution of ethology to clinical interpretation of the horse's welfare. *Equine veterinary Journal* 17:2-3.
- Ewer RF (1998). *The Carnivores*. Cornell University Press, Ithaca, NY, 500 pp.
- Farin PW, Slenning BD (2001) Managing reproductive efficiency in dairy herds. In: OM Radostits (ed) *Herd Health: Food Animal Production Medicine*, Saunders, Philadelphia, 3rd edn, pp. 255-290.
- Fazakerley J, Crossley J, McEwan N, Carter S, Nuttall T (2010). In vitro antimicrobial efficacy of β -defensin 3 against *Staphylococcus pseudintermedius* isolates from healthy and atopic canine skin. *Veterinary Dermatology* 21:463-468.
- Feeney DA, Johnston GR (2002). The uterus, ovaries and testes. In: *Textbook of Veterinary Diagnostic Radiology*, 4th edn, Saunders, Philadelphia, pp. 603-614.
- Fernandez PE, Portiansky EL, Barbeito CG, Gimeno EJ (1998). Characterisation of cytotrophoblastic-like cells present in subinvolutioned placental sites of the bitch. *Histology and Histopathology* 13:995-1000.
- Ferri STS, Vincente WRR, Toniollo GH (2003). Ultrasonographic study of the postpartum uterine involution in bitches after cesaerean section. *Arquivo Brasileiro de Medicina Veterinaria e Zootecnia* 55:167-172.
- Fieni F, Verstegen J, Heeraud V, Onclin K (1999). Physiology of prolactin, the pharmacology of prolactin inhibiting drugs and applications for bitches. *Pratique Medicale et Chirurgicale de l' Animal de Compagnie* 34:187-198.
- Fontbonne A, Malandain E (2006). Ovarian ultrasonography and follow-up of estrus in the bitch and queen. *Waltham Focus* 16(2):22-29.
- Fragkou IA, Gougoulis DA, Billinis C, Mavrogianni VS, Bushnell MJ, Cripps PJ, Tzora A, Fthenakis GC (2011). Transmission of Mannheimia haemolytica from the tonsils of lambs to the teat of ewes during sucking. *Veterinary Microbiology* 148:66-74.
- Fragkou IA, Mavrogianni VS, Cripps PJ, Gougoulis DA, Fthenakis GC (2007). The bacterial flora in the teat duct of ewes can protect against and can cause mastitis. *Veterinary Research* 38:525-545.
- Fthenakis GC (2000). Field evaluation of flunixin meglumine in the supportive treatment of ovine mastitis. *Journal of veterinary Pharmacology & Therapeutics* 23:405-407.
- Gabor G, Siver L, Szenci O (1999). Intravaginal prostaglandin F_{2a} for the treatment of metritis and pyometra in the bitch. *Acta veterinaria hungarica* 47:103-108.

- Glenn BL (1968). Subinvolution of placental sites in the bitch. *Proceedings of the 18th Gaines Veterinary Symposium*, White Plains, NY, USA, p. 7.
- Gobello C, Colombiani M, Scaglia H, De La Sota, Goya RG (2001). Heterogeneity of circulating prolactin in the bitch. *Reproduction Nutrition Development* 41:505-511.
- Golub MS, Kaaekuahiwi MA (1997). Changes in plasma α_1 -acid glycoprotein and albumin concentrations during late pregnancy in rhesus monkeys. *Clinica chimica Acta* 262:29-37.
- Gougoulis DA, Kyriazakis I, Fthenakis GC (2010). Diagnostic significance of behaviour changes of sheep: a selected review. *Small Ruminant Research* 92: 52-56.
- Gougoulis DA, Kyriazakis I, Papaioannou N, Papadopoulos E, Taitzoglou IA, Fthenakis GC (2008). Subclinical mastitis changes the patterns of maternal-offspring behaviour in dairy sheep. *Veterinary Journal* 176:378-384.
- Gougoulis DA, Kyriazakis I, Tzora A, Taitzoglou IA, Skoufos J, Fthenakis GC (2008). Effects of lamb sucking on the bacterial flora of teat duct and mammary gland of ewes. *Reproduction in Domestic Animals* 43:22-26.
- Gouletsou N, Fthenakis GC, Galatos AD (2002). Nutritional support and health care of orphan puppies or kittens during the first weeks of life. [in greek with English abstract] *Journal of the hellenic veterinary medical Society* 52:345-351.
- Graf KJ (1978). Serum oestrogen, progesterone and prolactin concentrations in cyclic, pregnant and lactating beagle dogs. *Journal of Reproduction and Fertility* 52:9-14.
- Groppetti D, Pecile A, Barbero C, Martino PA (2012). Vaginal bacterial flora and cytology in proestrous bitches: role on fertility. *Theriogenology* 77:1549-1556.
- Günzel-Apel AR, Hayer M, Mischke R, Wirth W, Hoppen HO (1997). Dynamics of haemostasis during the oestrous cycle and pregnancy in bitches. *Journal of Reproduction and Fertility* 51(Suppl):185-193.
- Gunzel-Apel A, Lubke A, Rohde J (1999). A comparative study on the vaginal and uterine cytology and bacterial flora during the estrus cycle and puerperium in beagle bitches. *Tierärztliche Praxis*, 27:112-119.
- Hartmann PE, Smith NA, Thompson MJ, Wakeford CM, Arthur PG (1997). The lactation cycle in the sow: physiological and management contradictions. *Livestock Production Science* 50:75-87.
- Hedlund CS (2007). Surgery of the reproductive and genital systems. In: TW Fossum, CS Hedlund, AL Johnson, KS Schulz, HB Saim III, MD Willard, A Bahr, GL Garroll (eds) *Small Animal Surgery*, 2nd edn. Mosby, St Louis, pp. 702-774.

- Hetch S (2008). Female reproductive tract. In: D Pennick, MA d'Anjou (eds) *Atlas of Small Animal Ultrasound*, Blackwell, Oxford, pp. 397-416.
- Hetts S, Clark JD, Calpin JP, Arnold CE, Mateo JM (1992). Influence of housing conditions on beagle behavior. *Applied Animal Behaviour Science* 34:137-155.
- Hirt RA, Kneissl S, Teinfalt M (2000). Severe hypercalcemia in a dog with a retained fetus and endometritis. *Journal of American Veterinary Medical Association* 216:1423-1425.
- Honda T, Honda K, Kokubun C, Nishimura T, Hasegawa M, Nishida A, Inui T, Kitamura K (2009). Time-course changes of hematology and clinical chemistry values in pregnant rats. *Journal of Toxicological Sciences* 33:375-380.
- Hoskins JD (1995). Nutrition and nutritional disorders. In: *Veterinary Pediatrics. Dogs and Cats from Birth to Six Months*, 2nd edn. Saunders, Philadelphia, pp. 511-524.
- Houpt KA (2000). Small animal maternal behaviour and its aberrations. In: KA Houpt (ed.) *Recent Advances in Companion Animal Behavior Problems*, IVIS, Ithaca.
- Hurley WL (1989). Mammary gland function during involution. *Journal of Dairy Science* 72:1637-1646.
- Isenberg HD, D'Amato RF (1985). Indigenous and pathogenic microorganisms of humans. In: EH Lennette, H Balows, WJ Hausler Jr, HJ Shadomy H.J. (eds) *Manual of Clinical Microbiology* American Society for Microbiology, Washington, pp. 24-35.
- Jackson CW, Steward SA, Ashmun RA, McDonald TP (1992). Megakaryocytopoiesis and platelet production are stimulated during late pregnancy and early postpartum in the rat. *Blood* 79:1672-1678.
- Jochle W (1997) Hormones in canine gynecology: a review. *Theriogenology* 3:152-163.
- Johnston SD, Kustritz MVR, Olson PNS (2001). *Canine and Feline Theriogenology*. Saunders, Philadelphia, 592 pp.
- Jung C, Wehrend A, Konig A, Bostedt H (2002). Investigations about the incidence, differentiation and microbiology of canine mastitis. *Praktische Tierärztliche* 83:508-511.
- Kaufman J (1986). Eclampsia in the bitch. In: *Current Therapy in Theriogenology*, 2nd edn. Saunders, Philadelphia, pp. 511-512.
- Kemper N, Preissler R (2011). Bacterial flora on the mammary gland skin of sows and in their colostrum. *Journal of Swine Health and Production* 19:112-115.

- Kendrick K, Keverne EB, Baldwin BA (1987). Intracerebroventricular oxytocin stimulate maternal behavior in sheep. *Neuroendocrinology* 46:56-61.
- Kim JC, Yum HI, Lim KH, Suh JE, Chung MK (2000). Haematological values during normal pregnancy in Sprague-Dawley rats. *Comparative Haematology International* 10:74-79.
- King RH, Le Dividich J, Dunshea FR (1999). Lactation and neonatal growth. In: I Kyriazakis (ed.) *A Quantitative Biology of the Pig*. CABI Publishing, Oxford, pp. 155-180.
- Kleiman DG, Eisenberg JF (1973). Comparisons of canid and felid social systems from an evolutionary perspective. *Animal Behaviour* 21:637-659.
- Knight PJ, Hamilton JM, Hiddleston WA (1977). Serum prolactin during pregnancy and lactation in beagles. *Veterinary Research* 101:202-203.
- Knight CH, Peaker M (1982). Development of the mammary gland. *Journal of Reproduction Fertility* 65:521-536.
- Krohn CC (2001). Effects of different suckling systems on milk production, udder health, reproduction, calf growth and some behavioural aspects in high producing dairy cows - a review. *Applied Animal Behaviour Science* 72:271-280.
- Kuhn G, Pohl S, Hingst V (1991). Elevation of the bacteriological content of milk of clinically unaffected lactating bitches of a canine research stock. *Berliner und Munchener Tierarztliche Wochenschrift* 104:130-133.
- Kustritz MVR (2005). Reproductive behaviour of small animals. *Theriogenology* 64:734-746.
- Kustritz MVR (2006). Collection of tissue and culture samples from canine reproductive tract. *Theriogenology* 66:567-574.
- Lee CS, Lascelles AK (1970). Histological changes in involuting mammary glands of ewes in relation to local allergic response. *Journal of Reproduction and Fertility* 21:373-376.
- Lewis KP, Jaffe S, Brannon EM (2005). Analog number representations in mongoose lemurs (*Eulemur mongoz*): evidence from a search task. *Animal Cognition* 8:247-252.
- Lind T (1980). Clinical chemistry of pregnancy. *Advances in clinical Chemistry* 21:1-24.
- Linde-Forsberg C (2005). Abnormalities in pregnancy, parturition and the periparturient period. In: SJ Ettinger, EC Feldman (eds) *Textbook of Veterinary Internal Medicine*, 6th edn. Saunders, Philadelphia, pp. 1664-1667.
- Linde-Forsberg C, Eneroth A (1998). Parturition. In: G Simpson, GCV England, M Harvey (eds) *Manual of Small Animal Reproduction and Neonatology*. British Small Animal Veterinary Association, pp. 127-142.

- Lorin D (1975). Peripartur and postpartur problems in the bitch and puppies. *Wiener Tierarztliche Monatsschrift* 62:345-347.
- Lurie S (1993). Changes in age distribution of erythrocytes during pregnancy: A longitudinal study. *Gynecologic and obstetric Investigation* 36:141-144.
- Macdonald DW, Carr GM (1995). Variation in dog society: between resource dispersion and social flux. In: J Serpell (ed) *The Domestic Dog: Its Evolution, Behaviour and Interactions with People*, Cambridge University Press, Cambridge, pp. 199-216.
- Magne ML (1986). Acute metritis in the bitch. In: DA Morrow (ed.) *Current Therapy in Theriogenology - Diagnosis, Treatment and Prevention of Reproductive Diseases in Small and Large Animals*, 2nd edn. Saunders, Philadelphia, pp. 505-506.
- Marco Melero JC (1994). *Mastitis in Laxta Breed Sheep: Epidemiology, Diagnosis and Control*. Doctoral Thesis, University of Zaragoza.
- Martin SL, Capen CC (1980). Puerperal tetany. In: RW Kirk (ed.) *Current Veterinary Therapy VII - Small Animal Practice*, Saunders, Philadelphia, pp. 1025-1027.
- Mattoon JS, Nyland G (2002). Ovaries and uterus. In: TG Nyland, JS Mattoon (eds) *Small Animal Diagnostic Ultrasound*, 2nd edn. Saunders, Philadelphia, pp. 231-266.
- Mavrogianni VS, Alexopoulos C, Fthenakis GC (2004). Field evaluation of flunixin meglumine in the supportive treatment of canine mastitis. *Journal of Veterinary Pharmacology and Therapeutics* 27:373-375.
- Mavrogianni VS, Cripps PJ, Fthenakis GC (2006). Description and validation of a novel technique to study the bacterial flora of the teat duct of ewes. *Small Ruminant Research* 66:258-264.
- Mavrogianni VS, Cripps PJ, Fthenakis GC (2007). Bacterial flora and risk of infection of the ovine teat duct and mammary gland throughout lactation. *Preventive Veterinary Medicine* 79:163-173.
- Mavrogianni VS, Fthenakis GC, Brooks H, Papaioannou N, , Taitzoglou I, Brellou G, Saratsis P (2005). The effects of inoculation of *Mannheimia haemolytica* into the teat of lactating ewes. *Veterinary Research*, 36:13-25.
- McGlone J, Pond WG (2002). *Pig Production: Biological Principles and Applications*. Delmar Cengage, Independence, 480 pp.
- Mendizabel, J.A.D. (1975). *A Study of the Mammary Gland of the Sow with Special Reference to Bacterial Mastitis and Lactational Failure*. PhD thesis, The Royal Veterinary College, University of London, 176 pp.

- Meuten DJ, Chew DJ, Kociba GJ, Capen CC (1982). Relation of serum total calcium to albumin and total protein in dogs. *Journal of American Veterinary Medical Association* 180:63-67.
- Meyer DJ, Harvey JW (1998). *Veterinary Laboratory Medicine Interpretation and Diagnosis*, 2nd edn. Saunders, Philadelphia, 373 pp.
- Michael SG (1996). *Istologia* [in greek] 2nd edn, Kiriakidis, Thessaloniki, 422 pp.
- Mizoguchi Y, Matsuoka T, Mizuguchi H, Endoh T, Kamata R, Fukuda K, Ishikawa T, Asano Y (2010). Changes in blood parameters in New Zealand White rabbits during pregnancy. *Laboratory Animals* 44:33-39.
- Munnich A, Kutzer P, Nattermann H (2000). Aerobic and anaerobic vaginal, milk and oral flora in bitches of a Golden Retriever kennel - the transmission to newborn puppies and relationship to reproductive disorders. *Reproduction in Domestic Animal* 35:20-21.
- Nak D, Nak Y, Tek HB (2005). Total uterine prolapse in a bitch. *Indian Veterinary Journal* 82:423-424.
- Nautrup CP (2001). Mammary Glands. In: CP Nautrup, R Tobias (eds) *An Atlas and Textbook of Diagnostic Ultrasonography of the Dog and Cat*, 2nd edn, Manson, London, pp. 322-328.
- Nielsen OL, Pedersen AR, Sorensen MT (2001). Relationships between piglet growth rate and mammary gland size of the sow. *Livestock Production Science* 67:273-279.
- Nissen E, Gustavsson P, Widström AM, Unväs-Moberg K (1998). Oxytocin, prolactin, milk production and their relation with personality traits in women after vaginal delivery and section caesarea. *Journal of Psychosomatic Obstetrics and Gynecology* 19:49-58.
- Noakes DE (2001). The puerperium and the care of the newborn. In: DE Noakes, TJ Parkinson, GCW England (eds) *Arthur's Veterinary Reproduction and Obstetrics*, 8th edn. Saunders, Edinburgh, pp. 189-202.
- Nowak R (1996). Neonatal survival: contribution from behavioural studies in sheep. *Applied Animal Behaviour Science* 49:61-72.
- Olson JD, Olson PN (1986). Disorders of the canine mammary gland. In: DA Morrow (ed.) *Current Therapy in Theriogenology - Diagnosis, Treatment and Prevention of Reproductive Diseases in Small and Large Animals*, 2nd edn. Saunders, Philadelphia, pp. 506-509.
- Opsomer G, Coryn M, deKruif A. (2002) Postpartum anoestrus in highyielding dairy cows. *Proceedings of the XXII World Buiatrics Congress, Hannover, Germany*, pp. 316-323.

- Orfanou DC, Athanasiou LV, Ververidis HN, Fthenakis GC (2009). Treatment of staphylococcal canine mastitis with clindamycin. *Proceedings of the 6th Annual Congress of the European Veterinary Society of Small Animal Reproduction*, Wroclau, Poland, p. 49.
- Pal SK (2005). Parental care in free-ranging dogs, *Canis familiaris*. *Applied Animal Behaviour Science* 90:31-47.
- Pal SK (2010). Play behavior during early ontogeny in free-ranging dogs. *Applied Animal Behaviour Science* 126:140-153.
- Palagi E (2007). Play at work: revisiting data focusing on chimpanzees (*Pan troglodytes*). *Journal of Anthropological Sciences* 85:63-81.
- Papworth TA, Clubb SK (1995). Clinical pathology in the female rat during the pre- and postnatal period. *Comparative Haematology International* 5:13-24.
- Peck TM, Arias F (1979). Hematologic changes associated with pregnancy. *Clinical Obstetrics and Gynecology* 22:785-798.
- Pedersen CA, Prange Jr AJ (1979). Induction of maternal behavior in virgin rats after intracerebroventricular administration of oxytocin. *Proceedings of the National Academy of Sciences of the USA* 76:6661-6665.
- Peter AT, Jakovljevic S (1992). Real-time ultrasonography of the small animal reproductive organs. *Compendium on continuing Education for the practicing Veterinarian* 14:739-746.
- Pharr JW, Post K (1992). Ultrasonography and radiography of the canine post-partum uterus. *Veterinary Radiology and Ultrasound* 33:35-40.
- Plommet M (1960). Staphylococcal mastitis in sheep. Experimental infection. *Annales de l' Institut Pasteur de Paris* 98:439-455.
- Potter TJ, Guitian J, Fishwick J (2010). Risk factors for clinical endometritis in postpartum dairy cattle. *Theriogenology* 74:127-134.
- Rao A, Sairam S, Shehata H (2004). Obstetric complications of twin pregnancies. *Best Practice and Research Clinical Obstetrics and Gynaecology* 18:557-576.
- Raynal-Ljutovac K, Pirisi A, De Cremoux R (2007). Somatic cells of goat and sheep milk: Analytical, sanitary, productive and technological aspects. *Small Ruminant Research* 68:126-144.
- Reberg SR, Peter AT, Blevins WE, (1992). Subinvolution of placental sites in dogs. *Compendium on continuing Education for the practicing Veterinarian* 14:789-796.

- Rehm S, Stanislaus DJ, Williams AM (2007). Estrous cycle-dependent histology and review of sex steroid receptor expression in dog reproductive tissues and mammary gland and associated hormone levels. *Birth Defects Research B* 80:233-245.
- Rheingold HL (1963). Maternal behavior in the dog. In: HL Rheingold (ed.) *Maternal Behavior in Mammals*, Wiley, New York, pp. 169-202.
- Ritt MG, Fossum TW (1997). Successful treatment of uterine torsion and fetal retention in a postparturient Great Pyrenees bitch with septic peritonitis and prothrombotic complications. *Journal of the American Animal Hospital Association* 33:537-539.
- Rossol TJ, Chew DJ, Nagode LA, Capen CC (1995). Pathophysiology of calcium metabolism. *Veterinary Clinical Pathology* 24:49-63.
- Sager M, Remmers C (1990). Perinatal mortality in dogs. Clinical, bacteriological and pathological studies. *Tierärztliche Praxis* 18:415-419.
- Sajonmaa-Koulumies LE, Loyd DH (1996). Colonization of the canine skin with bacteria. *Veterinary Dermatology* 7:153-162.
- Sajonmaa-Koulumies LE, Loyd DH (2002). Colonization of neonatal puppies by *Staphylococcus intermedius*. *Veterinary Dermatology* 13:123-130.
- Satué K, Munoz A, Blanco O (2010). Pregnancy influences the hematological profile of Carthusian broodmares. *Polish Journal of Veterinary Science* 13:393-394.
- Schäfer S, Breitenfellner J (2006). Bacteriological examination of the milk in case of septicaemia in neonate puppies. *Proceedings of the 5th Biannual Congress of the European Veterinary Society for Small Animal Reproduction*, Budapest, Hungary, p. 118.
- Schäfer-Somi S, Spargser J, Breitenfellner J, Aurich JE (2003). Bacteriological status of canine milk and septicaemia in neonatal puppies - A retrospective study. *Journal of Veterinary Medicine B* 50:343-346.
- Schall WD, Duncan JR, Finco DR, Knecht CD (1971). Spontaneous recovery after subinvolution of placental sites in a bitch. *Journal of American Veterinary Medical Association* 159:1780-1782.
- Schalm OW, Carroll EJ, Jain NC (1971). *Bovine Mastitis*, Lea and Febiger, Philadelphia, 360 pp.
- Schummer A, Nickel R, Sack WO (1979). Urogenital system. In: R Nickel, A Schummer, E Seiferle (eds) *The Viscera of the Domestic Mammals* Vol. II, 2nd edn. Paul Parey, Berlin, pp. 282-401.
- Schummer A, Wilkens H, Vollmerhaus B, Habermehl KH (1981). The circulatory system, the skin and the cutaneous organs of the domestic mammals. In: R Nickel, A Schummer, E Seiferle (eds) *The Viscera of the Domestic Mammals* Vol. III. Paul Parey, Berlin, pp. 441-610.

- Selman IE, McEwan AD, Fisher EW (1970). Some behavioural factors affecting absorption of immune lactoglobulin by newborn calves. *British veterinary Journal* 126:495-498.
- Serpell J, Jagoe JA (1995). Early experience and the development of behavior. In: J Serpell (ed) *The Domestic Dog: Its Evolution, Behavior and Interactions with People*, Cambridge University Press, Cambridge, pp. 79-102.
- Short RE, Bellow RA, Staigmiller RB, Berardinelli JG, Custer EE (1990) Physiological mechanisms controlling anestrus and infertility in post partum beef cattle. *Journal of animal Science* 68:799-816.
- Silver IA (1966). The anatomy of the mammary gland of the dog and cat. *Journal of small Animal Practice* 7:689-696.
- Skok J, Brus M, Skorjanc D (2007). Growth of piglets in relation to milk intake and anatomical location of mammary glands. *Acta agriculturae scandinavica Section A* 57:129-135.
- Slabbert JM, Rasa OAE (1993). The effect of early separation from the mother on pups in bonding to humans and pup health. *Journal of the south African veterinary Association* 64:4-8.
- Smith GW (2005). Supportive therapy of the toxic cow. *Veterinary Clinics of North America - Food Animal Practice* 21:595-612.
- Smith H (1995). The revival of interest in mechanisms of bacterial pathogenicity. *Biological Reviews* 70:277-316.
- Sodikoff CH (2001). *Laboratory Profiles of Small Animal Diseases. A Guide to Laboratory Diagnosis*, 3rd edn. Mosby, St Louis, 594 pp.
- Soede NM, Langendijk P, Kemp B (2011). Reproductive cycles in pigs. *Animal Reproduction Science* 124:251-258.
- Solter P, Hoffmann WE, Hungerford LL, Siegel JP, St Denis SH, Dorner JL (1991). Haptoglobin and ceruloplasmin as determinants of inflammation in dogs. *American Journal of veterinary Research* 52:1738-1742.
- Spinka M, Newberry RC, Bekoff M (2001). Mammalian play: training for the unexpected. *Quarterly Review of Biology* 76:141-168.
- Steinetz BG, Goldsmith LT, Lust G (1987). Plasma relaxin levels in pregnant and lactating dogs. *Biology of Reproduction* 17:719-725.
- Steinhardt M, Thielscher HH (2009). Haematological variables and plasma iron concentration of pregnant cows nursing or not nursing calves at pasture. *Tierärztliche Umschau* 63:482-489.
- Stone EA (2003). Reproductive system. In: D Slatter (ed.) *Textbook of Small Animal Surgery* Vol. II, 3rd edn. Elsevier, Philadelphia, pp. 1495-1499.

- Tejerina DFJC, Vega FJP (1995). Involution of placentation sites in the bitch. *Medecina Veterinaria* 12:328-332.
- Thebault A (2005). Hypocalcaemia in dogs and cats. *Point Veterinaire* 36:48-53.
- Toombs JP, Clarke KM (2003). Basic operative techniques. In: D Slatter (ed.) *Textbook of Small Animal Surgery* Vol. I, 3rd edn. Elsevier, Philadelphia, pp. 199-222.
- Trasch K, Wehrend A, Bostedt H (2007). Ultrasonographic description of canine mastitis. *Veterinary Radiology and Ultrasound* 48:580-584.
- Tucker HA (1981). Physiological control of mammary growth, galactogenesis and lactation. *Journal of Dairy Science* 64:1403-1421.
- VanDuijkeren E (1992). Significance of the vaginal bacterial flora in the bitch: a review. *Veterinary Record* 131:367-369.
- Ververidis HN, Boscós CM, Stamou AI, Alecopoulos C, Stefanakis A (2003). Pyometra in bitches following progestogen treatment: progesterone levels, ovarian-uterine findings and symptoms. *Reproduction in domestic Animals*. 38:345.
- Ververidis HN, Mavrogianni VS, Fragkou IA, Orfanou DC, Gougoulis DA, Gouletsou PG, Tzivara N, Boscós C, Fthenakis GC (2006). Experimentally induced canine mastitis: clinical, bacteriological, cytological, ultrasonographic, haematological and pathological features. *Proceedings of the 5th Biannual Congress of the European Veterinary Society for Small Animal Reproduction*, Budapest, Hungary, p. 291.
- Ververidis HN, Mavrogianni VS, Fragkou IA, Orfanou DC, Gougoulis DA, Tzivara N, Gouletsou PG, Athanasiou L, Boscós C, Fthenakis GC (2007). Experimental staphylococcal mastitis in bitches: clinical, bacteriological, cytological, haematological and pathological features. *Veterinary Microbiology* 124:95-106.
- Ververidis HN, Stamou AI, Papazoglou L, Kokoli AN, Fthenakis GC, Boscós C (2007). Extremely long retention of fetal remnants into the uterus of the bitch: description of three clinical cases. *Proceedings of the 5th Annual Congress of the European Veterinary Society of Small Animal Reproduction*, Lisbon, Portugal, p. 108.
- Wallace MS, Davidson AP (1995). Abnormalities in pregnancy, parturition, and the periparturient period. In: SJ Ettinger, EC Feldman (eds) *Textbook of Veterinary Internal Medicine*, 4th edn, Saunders, Philadelphia, pp. 1614-1624.
- Ward C, Trisko R, Smuts BB (2009). Third-party interventions in dyadic play between littermates of domestic dogs, *Canis lupus familiaris*. *Animal Behaviour* 78:1153-1160.

- Watts JR, Wright PJ, Lee CS (1998). Endometrial cytology of the normal bitch throughout the reproductive cycle. *Journal of small Animal Practice* 39:2-9.
- Wells G, Becker JC, Teng J, Dougados M, Schiff M, Smolen J, Aletaha D, van Riel PL (2009). Validation of the 28-joint disease activity score (DAS28) and European league against rheumatism response criteria based on C-reactive protein against disease progression in patients with rheumatoid arthritis, and comparison with the DAS28 based on erythrocyte sedimentation rate. *Reproduction in Domestic Animal*, 44(Suppl.):152-155.
- Wells MY, Decobecq CPM, Decouvelaere DM, Justice C, Guittin P (1999). Changes in clinical pathology parameters during gestation in the New Zealand White rabbit. *Toxicologic Pathology* 27:370-379.
- Wheeler SL (1986). Subinvolution of placental sites in the bitch. In: DA Morrow (ed.) *Current Therapy in Theriogenology - Diagnosis, Treatment and Prevention of Reproductive Diseases in Small and Large Animals*, 2nd ed, Saunders, Philadelphia, pp. 513-515.
- Wheeler SL, Magne ML, Kaufman J, Husted PW, Allen TA, Olson PN (1984). Postpartum disorders in the bitch. *Compendium on continuing Education for the practicing Veterinarian* 6:493-500.
- Whitman DC, Albers HE (1995). Role of oxytocin in the hypothalamic regulation of sexual receptivity in hamsters. *Brain Research* 680:73-79.
- Wiebe VJ, Howard JP (2009). Pharmacologic advances in canine and feline reproduction. *Topics in companion Animal Medicine* 24:71-99.
- Witt D, Winslow J, Insel T (1992). Enhanced social interaction in rats following chronic, centrally infused oxytocin. *Pharmacology Biochemistry and Behavior* 43:855-861.
- Wood DS (1986). Canine uterine prolapse. In: DA Morrow (ed.) *Current Therapy in Theriogenology - Diagnosis, Treatment and Prevention of Reproductive Diseases in Small and Large Animals*, 2nd ed, Saunders, Philadelphia, pp. 510-511.
- Wykes PM, Olson PN (1993). Diseases of the uterus. In: MJ Bojrad, D Smeak, M Blomberg (eds) *Disease Mechanisms in Small Animal Surgery*, 2nd ed, Lea and Febiger, Philadelphia, pp. 570-573.
- Yeager AE, Concannon PW (1990). Serial ultrasonographic appearance of postpartum uterine involution in beagle dogs. *Theriogenology* 34:523-535.
- Ziv C (1980). Practical pharmacokinetic aspects of mastitis therapy-2. Practical and therapeutic applications. *Veterinary Medicine and small Animal Clinician* 75:469-474.

