

UNIVERSITY OF THESSALY

DOCTORAL DISSERTATION

**Information models and systems for next
generation energy markets**

Author:
Magda FOTI

Supervisor:
Prof. Manolis VAVALIS

*A thesis submitted in fulfillment of the requirements
for the degree of Doctor of Philosophy*

in the

Department of Electrical and Computer Engineering

January 18, 2019

Declaration of Authorship

I, Magda FOTI, declare that this thesis titled, “Information models and systems for next generation energy markets” and the work presented in it are my own. I confirm that:

- This work was done wholly or mainly while in candidature for a research degree at this University.
- Where any part of this thesis has previously been submitted for a degree or any other qualification at this University or any other institution, this has been clearly stated.
- Where I have consulted the published work of others, this is always clearly attributed.
- Where I have quoted from the work of others, the source is always given. With the exception of such quotations, this thesis is entirely my own work.
- I have acknowledged all main sources of help.
- Where the thesis is based on work done by myself jointly with others, I have made clear exactly what was done by others and what I have contributed myself.

Signed:

Date:

The dissertation of Magda FOTI is approved by:

- Prof. Manolis Vavalis, University of Thessaly, Department of Electrical and Computer Engineering
- Prof. Lefteris Tsoukalas, University of Thessaly, Department of Electrical and Computer Engineering
- Associate Prof. Dimitrios Bargiotas, University of Thessaly, Department of Electrical and Computer Engineering
- Assistant Prof. Christos Antonopoulos, University of Thessaly, Department of Electrical and Computer Engineering
- Prof. Alexander Chroneos, Coventry University, Institute for Future Transport and Cities
- Prof. George Liberopoulos, University of Thessaly, Department of Mechanical Engineering
- Prof. George Papavassilopoulos, National Technical University of Athens, School of Electrical and Computer Engineering

UNIVERSITY OF THESSALY

Abstract

University of Thessaly
Department of Electrical and Computer Engineering

Doctor of Philosophy

Information models and systems for next generation energy markets

by Magda FOTI

The power grid is considered to be the most complex machine built by humanity. This system is currently experiencing a major transition. This transition has to face the increasing needs for energy in combination with the pressing problem of climate change. The main object of this dissertation is to exploit the ways in which, active participation, both from demand and supply side, in energy markets can result in power and economic stability.

This PhD thesis is about exploiting recent developments in Power Grids, Data Analytics, Game Theory, Internet of Things and Blockchain to design and develop a prototype system that incorporates the following desirable characteristics:

- Incorporates business logic into devices for participation in open energy markets without intermediaries, such as for devices consuming energy in residential houses and distributed energy sources both connected in a smart grid.
- Provides, through machine learning, intelligence to these devices required for market efficiency and stability.
- Enables market decentralization by designing effective consensus algorithms tailored to the needs of the power grid.
- Integrates power and economic stability considering both physical laws, ruling the power grid and social abilities, of the market participants.

The information models and systems designed and implemented in this work are tested in large scale experiments, simulating power grids with distributed generation with high penetration of renewable energy sources and active demand that responds to pricing signals.

Περίληψη

Τμήμα Ηλεκτρολόγων Μηχανικών και Μηχανικών Υπολογιστών

Διδακτορικό Δίπλωμα

Πληροφοριακά Μοντέλα και Συστήματα για Αγορές Ενέργειας Νέας Γενιάς

Μαγδαληνή Φώτη

Το δίκτυο ηλεκτρικής ενέργειας θεωρείται το πιο πολύπλοκο σύστημα που έχει κατασκευαστεί από την ανθρωπότητα. Αυτό το σύστημα βιώνει σήμερα μια σημαντική μετάβαση. Μέσω αυτής της μετάβασης πρέπει αντιμετωπιστεί η αυξανόμενη ανάγκη για ενέργεια σε συνδυασμό με το πιεστικό πρόβλημα της κλιματικής αλλαγής. Ο κύριος στόχος της παρούσας διατριβής είναι να αξιοποιήσει τους τρόπους με τους οποίους η ενεργός συμμετοχή, τόσο από πλευράς ζήτησης όσο και από πλευράς προσφοράς, στις αγορές ενέργειας μπορεί να οδηγήσει σε ενεργειακή και οικονομική ισορροπία.

Αυτή η διδακτορική διατριβή αφορά στην αξιοποίηση των πρόσφατων εξελίξεων στα Δίκτυα Ηλεκτρικής Ενέργειας, την Ανάλυση Δεδομένων, τη Θεωρία Παιγνίων, το Δίκτυο των πραγμάτων και της τεχνολογίας του **Blockchain** για να σχεδιάσει και να αναπτύξει ένα πρωτότυπο σύστημα που ενσωματώνει τα ακόλουθα επιθυμητά χαρακτηριστικά:

- Ενσωματώνει την επιχειρησιακή λογική σε συσκευές για συμμετοχή σε ανοικτές αγορές ενέργειας χωρίς μεσάζοντες, όπως για συσκευές που καταναλώνουν ενέργεια σε κατοικίες και καταναμεμημένες πηγές ενέργειας που συνδέονται σε ένα έξυπνο δίκτυο.
- Παρέχει, μέσω της μηχανικής μάθησης, πληροφορίες για αυτές τις συσκευές που απαιτούνται για την αποτελεσματικότητα και τη σταθερότητα της αγοράς.
- Επιτρέπει την αποκέντρωση της αγοράς σχεδιάζοντας αποτελεσματικούς αλγόριθμους συναίνεσης προσαρμοσμένους στις ανάγκες του ηλεκτρικού δικτύου.
- Ενσωματώνει την ενεργειακή και την οικονομική σταθερότητα όσον αφορά τόσο τους φυσικούς νόμους, που ορίζουν την λειτουργία του δικτύου ηλεκτρικής ενέργειας όσο και τις κοινωνικές δυνατότητες των συμμετεχόντων στην αγορά.

Τα πληροφοριακά μοντέλα και συστήματα που σχεδιάστηκαν και υλοποιήθηκαν σε αυτή την εργασία δοκιμάζονται με πειράματα μεγάλης κλίμακας, τα οποία προσομοιώνουν ηλεκτρικά δίκτυα με καταναμεμημένη παραγωγή, υψηλή διείσδυση ανανεώσιμων πηγών ενέργειας και ενεργή ζήτηση που ανταποκρίνεται σε σήματα τιμής.

Acknowledgements

First of all, I would like to thank my advisor, Prof. Manolis Vavalis, for being a great mentor and teacher. I would like to thank him for the scientific guidance, the valuable advice, the time he spent on constructive debates and the moral support he provided me throughout this work.

I would also like to thank my dissertation committee members; Prof. Lefteri Tsoukala, Associate Prof. Dimitrios Bargiotas, Assistant Prof. Christos Antonopoulos, Prof. Alexander ChronEOS, Prof. George Limperopoulos and Prof. George Papavassilopoulos, for generously sharing their expertise and time in reviewing this thesis.

This research has been financially supported by the General Secretariat for Research and Technology (GSRT) and the Hellenic Foundation for Research and Innovation (HFRI) (Scholarship Code: 769)

Publications

Parts of the results of this dissertation are described in the following publications.

Articles Published in Journals

1. M. Foti and M. Vavalis, "Intelligent Bidding in Smart Electricity Markets", *International Journal of Monitoring and Surveillance Technologies Research*, vol. 3, no. 3, pp. 68–90, Jul. 2015, ISSN: 2166-7241. DOI: [10.4018/IJMSTR.2015070104](https://doi.org/10.4018/IJMSTR.2015070104). [Online]. Available: <http://services.igi-global.com/resolvedoi/resolve.aspx?doi=10.4018/IJMSTR.2015070104>
2. M Foti, A Nasiakou, L Vasilaki, *et al.*, "On Visualizing Distribution Systems for Next Generation Power Distribution Grids", *International Journal of Computational & Neural Engineering*, pp. 16–27, Jun. 2016. DOI: [10.19070/2572-7389-160004](https://doi.org/10.19070/2572-7389-160004). [Online]. Available: <https://scidoc.org/articlepdfs/IJCNE/IJCNE-2572-7389-03-101.pdf>

Articles Published in Books or Conference Proceedings

1. M. Foti and M. Vavalis, "A learning approach for strategic consumers in smart electricity markets", in *2015 6th International Conference on Information, Intelligence, Systems and Applications (IISA)*, IEEE, Jul. 2015, pp. 1–6, ISBN: 978-1-4673-9311-9. DOI: [10.1109/IISA.2015.7388043](https://doi.org/10.1109/IISA.2015.7388043). [Online]. Available: <http://ieeexplore.ieee.org/lpdocs/epic03/wrapper.htm?arnumber=7388043>
2. N. Akram, S. De Silva, M. Foti, *et al.*, "Real time data analytics platform for power grid smart applications", in *2017 14th International Conference on the European Energy Market (EEM)*, IEEE, Jun. 2017, pp. 1–6, ISBN: 978-1-5090-5499-2. DOI: [10.1109/EEM.2017.7982012](https://doi.org/10.1109/EEM.2017.7982012). [Online]. Available: <http://ieeexplore.ieee.org/document/7982012/>
3. M. Foti, D. Greasidis, and M. Vavalis, "Viability Analysis of a Decentralized Energy Market Based on Blockchain", in *2018 15th International Conference on the European Energy Market (EEM)*, IEEE, Jun. 2018, pp. 1–5, ISBN: 978-1-5386-1488-4. DOI: [10.1109/EEM.2018.8469906](https://doi.org/10.1109/EEM.2018.8469906). [Online]. Available: <https://ieeexplore.ieee.org/document/8469906/>

Articles to be Published in Journals

1. M. Foti, D. Greasidis, and M. Vavalis, "Blockchain Based Uniform Price Double Auctions for Energy Markets", *to be submitted to IEEE on Smart Grids*, 2018. [Online]. Available: <https://doi.org/10.6084/m9.figshare.6840614.v2>
2. M. Foti, K Mavromatis, and M. Vavalis, "Blockchain Design and Implementation for Decentralized Optimal Power Flow", *to be submitted to Applied Energy*, 2018. [Online]. Available: <https://doi.org/10.6084/m9.figshare.7093835.v2>
3. M. Foti and M. Vavalis, "What blockchain can do for power grids?", *to be submitted to Renewable and Sustainable Energy Reviews*, 2018. [Online]. Available: <https://figshare.com/s/6dbdf69c0f7289077281>
4. C. Antonopoulos, M. Foti, D. Greasidis, *et al.*, "Inspecting and Analyzing Blockchain Applications", *to be submitted to Empirical Software Engineering*, 2018. [Online]. Available: <https://figshare.com/s/925eb7a859a21e28da7d>

Other Publications in Conferences and Journals

The following Publications have also contributed to this thesis but in an indirect and, to a large extend, peripheral way.

1. O. Meikopoulos, M. Vavalis, and M. Foti, "Towards a remedial and rehabilitation e-tourism system", in *Proceedings of the IADIS International Conference on WWW/Internet*, 2015, p. 151
2. M Foti, E Papa, and M Vavalis, "Monitoring an Institution's Research Activities", *International Journal of Information and Education Technology*, vol. 7, no. 5, p. 350, 2017
3. E. Z. Tragos, M. Foti, M. Surligas, *et al.*, "An IoT based intelligent building management system for ambient assisted living", in *2015 IEEE International Conference on Communication Workshop (ICCW)*, IEEE, Jun. 2015, pp. 246–252, ISBN: 978-1-4673-6305-1. DOI: [10.1109/ICCW.2015.7247186](https://doi.org/10.1109/ICCW.2015.7247186). [Online]. Available: <http://ieeexplore.ieee.org/document/7247186/>
4. S. Kyriazakos, G. Labropoulos, N. Zonidis, *et al.*, "Applications of Machine Learning and Service Oriented Architectures for the New Era of Smart Living", *Journal of Communication, Navigation, Sensing and Services*, vol. 1, pp. 181–196, 2014. DOI: [10.13052/jconasense2246-2120.124](https://doi.org/10.13052/jconasense2246-2120.124). [Online]. Available: https://www.riverpublishers.com/journal/journal_articles/RP_Journal_2246-2120_124.pdf
5. S. Kyriazakos, G. Labropoulos, N. Zonidis, *et al.*, "Novel building management system based on machine learning and a cloud-based SOA for Ambient Living", in *2014 4th International Conference on Wireless Communications, Vehicular Technology, Information Theory and Aerospace & Electronic Systems (VITAE)*, IEEE, May 2014, pp. 1–5, ISBN: 978-1-4799-4624-2. DOI: [10.1109/VITAE.2014.6934483](https://doi.org/10.1109/VITAE.2014.6934483). [Online]. Available: <http://ieeexplore.ieee.org/document/6934483/>

Contents

Declaration of Authorship	iii
Abstract	v
Acknowledgements	ix
Publications	xi
I Preliminaries	1
1 Introduction	3
1.1 Energy Transitions	3
1.2 Contribution of this Dissertation	5
2 Basic Concepts and Enabling Technologies	9
2.1 The power grid	9
2.1.1 Power Flow Problem	9
2.1.2 Optimal Power Flow	10
2.2 Electricity Markets	11
2.2.1 Economic Dispatch	12
2.2.2 Different Markets	14
2.2.3 Demand-Side Participation	16
2.2.4 Transmission System Representation	16
2.2.5 Challenges	19
2.3 Data Analytics	19
2.3.1 Predictive Data Analytics	20
2.4 Game Theory	22
2.4.1 Nash Equilibrium	23
2.5 Distributed Ledger Technology	23
2.5.1 Blockchain	24
2.5.2 Access Rights	26
2.5.3 Consensus Algorithms	27
2.5.4 Smart Contracts	30
2.6 Software Systems	31
2.6.1 Power Grid Simulation Platform	31
2.6.2 Data Analytics Platform	32
2.6.3 Blockchain Client	33
II Systems and Data Analysis	35
3 Real-Time Data Analytics Platform for Power Grids	37
3.1 Introduction	37

3.2	Basic Concepts, Objectives and Software Systems	39
3.3	Modules for Decision and Equilibrium	40
3.3.1	Prediction Modules	40
3.3.2	Game Theory Modules	41
3.4	Prototype Implementation and Indicative Experimentation	42
3.5	Synopsis and Prospects	46
4	Visualizing Power Distribution Systems	47
4.1	Introduction	47
4.2	Related Work	48
4.3	Design and implementation	49
4.3.1	Technologies	49
4.3.2	Prototype Implementation	50
4.4	Summary	53
5	Machine Learning	55
5.1	Introduction	55
5.2	Energy Grids and Learning Methods	56
5.2.1	Next Generation Energy Grids and Markets	56
5.2.2	Learning Methods	57
5.3	Related Work	58
5.4	Learning in GridLAB-D	59
5.5	Experimentation	60
5.6	Synopsis and Future Prospects	64
6	Utilizing Game Theory	65
6.1	Introduction	65
6.2	Related Work	65
6.3	Game Formulation	66
6.3.1	Nash Equilibrium	67
6.3.2	Supply prediction algorithm	68
6.4	Experimentation	68
6.5	Synopsis and future prospects	71
III	Towards Decentralized Operation	75
7	What Blockchain can do for Power Grids?	77
7.1	Introduction	77
7.2	Power Grids and Blockchain	78
7.2.1	Review of reviews	78
7.3	Related peer-reviewed publications	79
7.3.1	Power Flow	80
7.3.2	Emission Reduction	80
7.3.3	Energy Markets	81
7.3.4	Batteries	82
7.3.5	Demand Response	82
7.3.6	Electric Vehicles	83
7.3.7	Security and Privacy	83
7.3.8	Other	84
7.4	Horizon 2020 Projects	84
7.5	Entrepreneurial efforts	86

7.6	Concluding remarks	88
8	Blockchain Based Uniform Price Double Auctions for Energy Markets	91
8.1	Introduction	91
8.2	Background and Concepts	92
8.3	Related Studies	94
8.4	Design and Implementation	94
8.4.1	Market implementation approaches	97
8.5	Simulation Study	100
8.5.1	Experimental Configuration	100
8.5.2	Effectiveness	100
8.5.3	Cost	106
8.5.4	Decentralization	107
8.5.5	Security	107
8.6	Synopsis and Prospects	108
9	Blockchain Design and Implementation for Power Grid	111
9.1	Introduction	111
9.2	Optimal Power Flow and Energy Markets	112
9.3	Decentralized Optimal Power Flow	113
9.3.1	ADMM in Optimal Power Flow	113
9.4	Blockchain in decentralized Optimal Power Flow	116
9.5	Experimental Analysis	116
9.5.1	Quality and Convergence of Solution	118
9.5.2	Blockchain - Gas Usage	118
9.5.3	Convergence Robustness	122
9.5.4	The special case of ' <i>one Bus per Region</i> '	122
9.6	Related Work	123
9.6.1	Differences	123
9.7	Synopsis and Research Plans	124
10	Inspecting Blockchain Applications	125
10.1	Introduction	125
10.2	Related Work	125
10.3	Design and Implementation of an Inspector/Visualizer	129
10.3.1	Developing a Dapp	129
10.3.2	Prototype Implementation	131
IV	Conclusion	135
11	Synopsis and Future Work	137
11.1	Synopsis	137
11.2	Future Prospects	138
	Bibliography	141

List of Figures

1.1	Global energy consumption and transitions, 1800–2010. Source: [17]	7
1.2	Energy use in the power sector. Source: [20]	7
1.3	Duck curve effect. Source: [21]	8
2.1	Dispatch Curve. Source: [30]	13
2.2	Energy Supply and Demand in a Complete Market. Source: [30]	13
2.3	Optimized Consumption Using Demand Response. Source: www.nwccouncil.org	17
2.4	European Bidding Zones. Source: www.tennet.eu	18
2.5	Locational Marginal Prices in PJM Region. Source: www.pjm.com	19
2.6	Predictive data analytics process. Source: [37]	21
2.7	Underfitting on the left, Optimal and Underfitting on the right	22
2.8	Cryptographically Secured Chain of Documents. Source: [43]	24
2.9	Cryptographically Secured Chain of Blocks Source: [43]	24
2.10	Blockchain	26
2.11	GridLAB-D Architecture. Source: https://sourceforge.net/projects/gridlab-d/	31
2.12	DAS Architecture. Source: https://docs.wso2.com/display/DAS310/Architecture	32
3.1	The functional view of the system architecture considered	38
3.2	The component view of the system architecture used in our study	40
3.3	Clearing price prediction(top), Supply Prediction(bottom)	41
3.4	WSO2 DAS Dashboard	42
3.5	House Air Temperature	44
3.6	Market Clearing Prices	44
3.7	Total Demand	46
4.1	Schematic illustration of MVC Architecture	49
4.2	The homepage	52
4.3	Self-Organizing Map Initialization Page	53
4.4	Self-Organizing Map resulting U-Matrix with Neuron features values shown	53
5.1	The 24 hour hourly PJM-reported local marginal prices at Newark Bay for every day in February 2013 (Source: http://www.pjm.com).	56
5.2	The IEEE-13 test feeder.	61
5.3	House temperature variations in the presence of wind turbines only. No-learning data are represented in black colour and learning in red. EX5, EX7, Ex9 and EX11 are associated with top left, top right, bottom left and bottom right accordingly.	63
5.4	Clearing Prices when all consumers use machine learning algorithm	64

6.1	Supply prediction. Supply from wind turbines (top) and wind turbines and solar panels (bottom).	69
6.2	House temperature variations in the presence of wind turbines only.	70
6.3	Consumers' total demand.	72
7.1	Number of publications per year retrieved from Scopus using "blockchain" as keyword search (results retrieved on 02/09/2018).	79
7.2	Peer-reviewed publications	80
7.3	Industries developing blockchain today. Source [158]	86
8.1	Enabling Components for Transactive Energy Networks.	91
8.2	Uniform Price, Double Auction Market Clearing.	91
8.3	P2P Blockchain Network	95
8.4	Communication steps in A1 and A2 approaches	98
8.5	Communication steps in A3 approach	99
8.6	Generation capacity	102
8.7	Clearing price(left column) and clearing quantity(right column) results	103
8.8	Clearing price scaled error for 540 (left) and 1000 (right) market participants with a 5' auction period.	104
8.9	Uniform Price, Double Auction Market Clearing.	106
9.1	Wholesale Competitive Market. Source [193]	112
9.2	Duplicating voltages at boundaries of regions.[202]	113
9.3	Preparation of the algorithm per region for a given problem. (Images adaptations from [202], here)	117
9.4	Algorithm Implementation in the Architecture. (Images adaptations from [202], here)	117
9.5	From left to right: The IEEE 30-Bus Test Case (Source), the 39-Bus Case (Source), the 118-Bus Case (Adapted from here).	118
9.6	Iterations until convergence per region (top) and Locational Prices at the Buses (bottom) for the Test Cases.	119
9.7	Active Power Generation between the Decentralized and Centralized solution of the 39-Bus Case: Flat Start on the top plots, Warm Start on the bottom plots	120
9.8	Estimated Gas until Convergence for different Cases.	120
9.9	Convergence in 39-Bus Case	121
9.10	The IEEE 57-Bus Case (Source)	122
9.11	Results in power generation of the 57-Bus Case	123
10.1	Block information	131
10.2	Number of transactions per block	131
10.3	Gas spent per block	132
10.4	Transaction information	132
10.5	Gas Spent by account	132
10.6	Contract variables	133

List of Tables

1.1	Generation Technologies and their characteristics	5
3.1	Prediction models	40
3.2	Power sources and their characteristics	43
3.3	Clearing Prices (in €/KWh)	43
3.4	Cost Variation	43
3.5	Total Demand and its Characteristics	45
5.1	Power sources and their characteristics.	60
5.2	The various experiments and their characteristics	61
5.3	Total price paid or earned (in €) and total quantity bought or sold (in KW) for the various experiments	63
6.1	The various experiments and their characteristics	69
6.2	Total price paid (in €) or earned (in million €) and total quantity bought (in KW) or sold (in million KW) for the various experiments	71
6.3	Demand Characteristics	71
7.1	Categorization of peer-reviewed publications	79
7.2	List of EU supported projects.	85
7.3	List of Entrepreneurial efforts. Market Capitalization of May 2018	89
8.1	Transaction Fields	99
8.2	Setup and results	101
9.1	Metrics on different Cases	118
10.1	Vulnerabilities in a Dapp	126
10.2	Features offered by the Inspector-Analyzer (in the first column) and their availability in related tools.	130

For/Dedicated to/To my...

Part I

Preliminaries

Chapter 1

Introduction

1.1 Energy Transitions

The term *energy transition* describes the switch from an economic system dependent on one or a series of energy sources and technologies to another[15]. Energy systems have gone through several transitions in the past, while another one is currently ongoing.

Before industrialization, the only energy source available to mankind was the energy generated by human or animal physical labour. Later firewood and primitive water and wind mills complemented labour.

During the 18th century, the invention of the steam engine and the beginning of the industrial revolution increased the demand for combustible fuels. Firewood and charcoal could not serve the increasing demand any more, so society turned to coal. This marked the beginning of fossil fuel era.

In the 19th century and due to the emergence of industries, first in the United Kingdom and the USA, the coal production increased rapidly making coal the main energy source for the industrialized nations. Therefore, the transition to coal is connected with the Industrial Revolution, both as cause and as effect.

The petroleum era started with the discovery of oil in 1859 in Pennsylvania. Petroleum became predominant over coal, especially after the introduction of the internal combustion engine and the revolutionization of mobility with the introduction of cars[16].

We can clearly see in Figure 1.1 that, although each energy transition changed the main energy source and the percentage of each source in the total energy consumption, the absolute consumption for each source continues to increase.

The history of energy transitions has been studied extensively. There is no evidence though that the current energy transition will have the same temporal dynamics as the previous. Energy transitions of the past took decades to unfold and the problems that needed to be addressed were internal to society. Current energy transition is driven by the fact that our energy systems are no longer sustainable, the climate change raises issues that go beyond profits and losses of people that decide fuel and technologies used by energy systems[18].

The term *Carbon budget* was recently introduced by the Intergovernmental Panel on Climate Change (IPCC). Carbon budget is the maximum amount of carbon dioxide that can be emitted, if humanity wants to have a chance of averting the most dangerous impacts of climate change. The international scientific community has quantified this budget to be 1 trillion tonnes of carbon. Under current and planned policies, including the contributions determined by nations in Paris Agreement, the world will spend this budget in less than 20 years[19] from now.

However, according to International Renewable Energy Agency (IRENA) the target set by the historic 2015 climate accord, to reduce average global temperature rise

to *well below* 2°C, can be met in a large percentage by renewable energy and energy efficiency. According to IRENA, renewable energy and energy efficiency in combination can provide over 90% of the necessary energy-related CO₂ emission reductions at the necessary speed[20].

IRENA's global road-map for scaling up renewables, known as REmap is summarized in Figure 1.2. In Figure 1.2 the necessary changes needed to fight climate change and that could be achieved following REmap for the power sector are illustrated.

However the use of renewable energy and energy efficiency will not solve all the problems. On the contrary it may cause operational and planning issues on power systems.

The main problem caused is that a decreasing share of energy supply is dispatchable. Supply from renewable sources mainly depends on weather conditions and has indeed strong variations. As the portion of supply from renewables grows the share of dispatchable sources decreases.

Another effect caused by the penetration of renewables is known with the term *duck curve effect*[21]. Duck curve effect describes the challenge of accommodating solar energy and the potential for overgeneration and solar curtailment. In Figure 1.3 each line represents the net load, equal to the normal load minus wind and solar generation. The "belly" of the duck is when the solar generation is at its maximum so the net load reaches its minimum. The "belly" grows as penetration of renewable sources increases between 2012 and 2020. During this period the system operator must reduce output from the dispatchable generation facilities and balance demand with supply using the output of renewables.

The overgeneration problem comes up when generation from dispatchable resources cannot be further limited to accommodate the supply of generation from renewables. A solution for the overgeneration problem is the curtailment. Curtailment is the reduction of the output from a wind or PV plant below what it can produce by the system operator. Although curtailment is a technically easy solution to provide stability to the grid, it has the undesired effect of reducing the environmental and economic benefits of renewable generation.

In Figure 1.3 we can see the point at which overgeneration risk occurs. During this time of the day the system operator prepares to meet the upward ramp that is coming. This preparation is achieved by turning on conventional generation, including generation sources with long start-up times. This results in a production at a minimum level during times that electricity is not needed. Overgeneration may also result from plants that cannot be turned-off due to issues connected to local voltage support, reliability and institutional constraints. Another factor that can cause curtailment are transmission constraints.

In Table 1.1 we summarize the different generation technologies according to the capacity, fuel type and its amount of flexibility.

Apart from supply side, the energy systems today are simultaneously going through demand-side changes. These changes include Distributed Energy Resources (DERs), novel uses of energy, like Electric Vehicles (EVs) and Advanced Metering Infrastructure (AMI).

A growing number of DERs are installed by end customers, a part of their supply is used for self-consumption and the rest is either sold in an energy market or provided to the grid with a feed-in-tariff. This kind of distributed generation is controlled by its owner and not by the system operator. This ownership status essentially removes the option of curtailing the supply of these resources, or moving it to time periods according to system needs even if it is dispatchable.

TABLE 1.1: Generation Technologies and their characteristics

	Capacity Type	Fuel Type	Flexibility
Coal	Fixed	Fossil	Medium
Natural Gas	Fixed	Fossil	High
Nuclear	Fixed	Nuclear	Low
Hydroelectric	Fixed	Renewable	Very High
Solar	Variable	Renewable	Very Low
Wind	Variable	Renewable	Very Low
Geothermal	Fixed	Renewable	High
Biomass	Fixed	Renewable	Medium

EVs also increase the demand from the supply side. However, even though they increase the load during some time periods they can also be used as distributed storage.

Both DERs and EVs result in higher stochasticity from the demand side. However, if these changes in the demand side are integrated correctly, they may lead to greater flexibility which is so much needed for the scaling-up of renewables. AMI, which enables two-way communication between the consumer and the supplier, can contribute to coordination of supply with demand according to power system needs.

1.2 Contribution of this Dissertation

A number of observations naturally arise from the study of past energy transitions [18]. We list them below and we believe that they may prove themselves helpful in the future:

- People respond to price incentives.
- Science is essential but not adequate.
- Human capital is critical.
- Cooperation is as critical as competition.
- Disruptive technologies need time to mature.

With these observations in mind, in this dissertation we study how novel technologies may help energy producers, consumers and prosumers (those who both consume and produce) to participate effectively in energy markets. We study how demand side may participate in large percentages directly in new generation energy markets not only by responding to pricing signals but also by examining how their participation may, either collaboratively or competitively, contribute to achieving equilibrium. In other words, how from price takers they could become price makers. Also, we study how power grids and energy markets can benefit from the utilization of distributed ledger technology which is commonly characterized as disruptive.

The rest of this dissertation is organized as follows. Each chapter focuses on a specific issue, presenting both the related studies existing in literature and our contribution to it.

Chapter 2 sets the required background and presents the basic concepts involved. It contains a detailed overview of how energy markets operate today and focuses

on the challenges they face. It also provides a general background of the modern enabling technologies utilized, namely the machine learning technology, elements of game theory, selected theory and practices in data analysis and the distributed ledger technology. Also, chapter 2 offers a description of the tools used for the experimental purposes of this dissertations.

Part II includes our work concerning data analysis.

More specifically, chapter 3 describes the design and the implementation of a prototype simulation engine that couples state-of-the-art software from both the electrical engineering and information sciences. This effort resulted in the creation of an open-source, open-architecture simulation engine that delivers large scale data analytics for the efficiency and stability of next generation power distribution grids. This work is a part of our cooperation with WSO2, a worldwide recognized company as an open source technology provider.

Chapter 4 concerns Self Organizing Maps (SOMs) that combines visualization and machine learning to analyze data. Our work on using SOMs to visualize the results generated by powerflow analysis is presented in this chapter.

Chapter 5 contains our efforts on using machine learning models, described in Chapter 2, to provide economic benefits to energy market participants. These efforts include utilization of machine learning algorithms to predict market clearing prices and supply from renewable energy sources. The results of giving access to these algorithms to all market participants are studied through systematic and extensive large scale simulations.

Chapter 6 provides a detailed discussion on elements of game theory and how they can be utilized in the context of energy markets. A non-cooperative game between energy consumers is described, market and power stability effects are presented, analyzed and compared with the results of chapter 5.

Part III includes our work leveraging distributed ledger technology.

More specifically, chapter 7 is a review on existing and emerging ways in which the energy industry can exploit the methodology and practice of the distributed ledger technology. Efforts coming both from the scientific community and from industry are presented.

Chapter 8 describes our design, implementation and analysis efforts for an effective decentralized energy market. Simulation results and a preliminary analysis on decentralization, operating costs, computational costs, effectiveness, security, privacy and beyond is also included.

In chapter 9 we design and implement a distributed and decentralized Optimal Power Flow (OPF) algorithm. This decentralization is based on the grounds of the Alternating Direction Method of Multipliers (ADMM) and allows us to achieve the full decentralization of the system. Our decision to integrate OPF with the consensus algorithm of the blockchain technology creates an autonomous grid, able to take collective decisions for the benefit of all its members.

Chapter 10 includes an effort on developing a tool monitoring the operation of distributed applications. This software tool allowed us to develop the distributed applications described in chapter 8 and analyze the experimental results.

Finally, chapter 11 summarizes the work conducted in the frame of this dissertation and briefly presents its future prospects.

It should be pointed out that chapters 5 and 6 contain material from papers [1] and [3], chapter 3 from [4], chapter 7 from paper [8], chapter 8 from [5] and [6], chapter 9 from [7], and finally chapter 10 from [9].

Although most energy electricity ???????

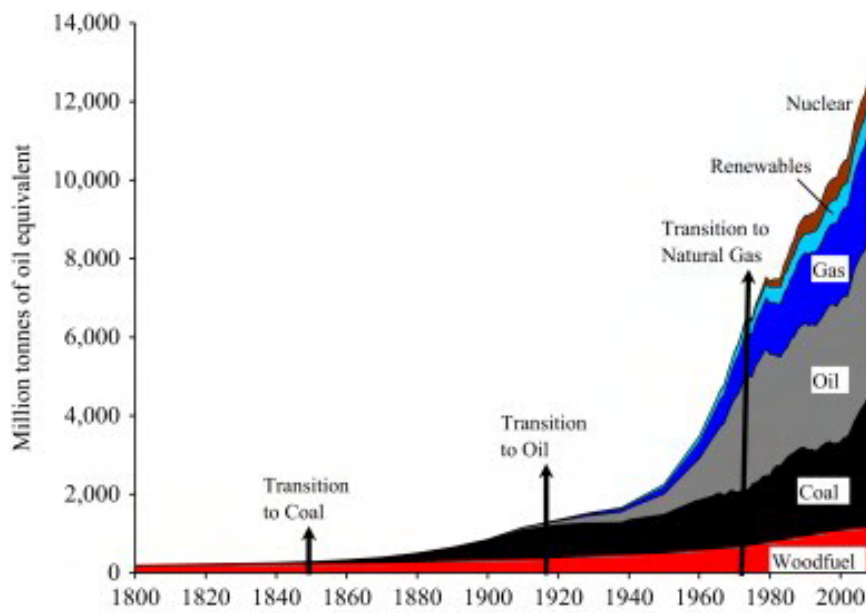

FIGURE 1.1: Global energy consumption and transitions, 1800–2010. Source: [17]

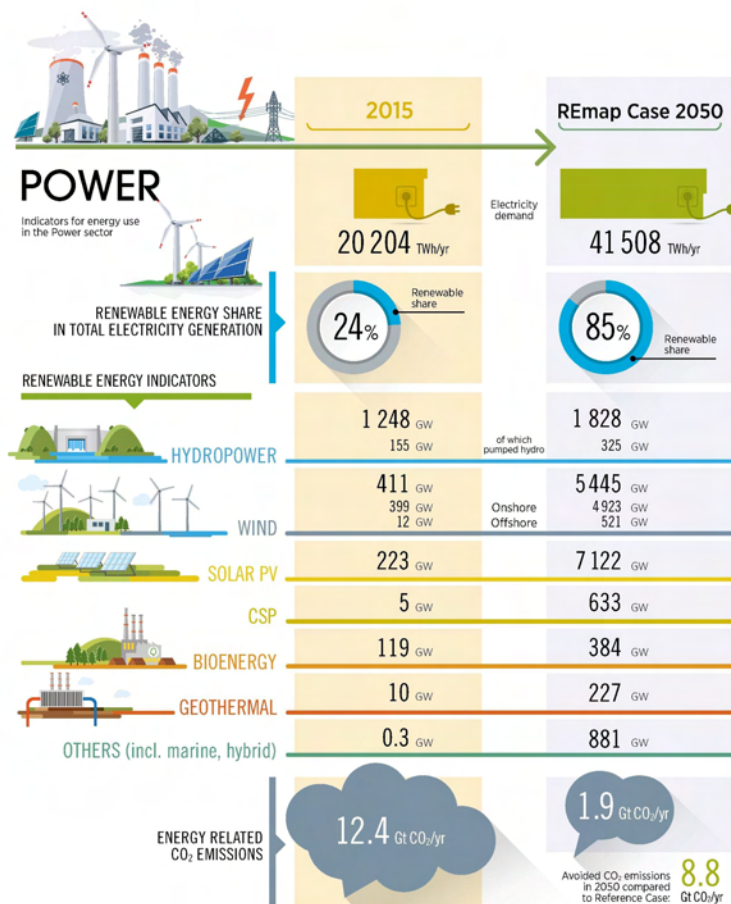

FIGURE 1.2: Energy use in the power sector. Source: [20]

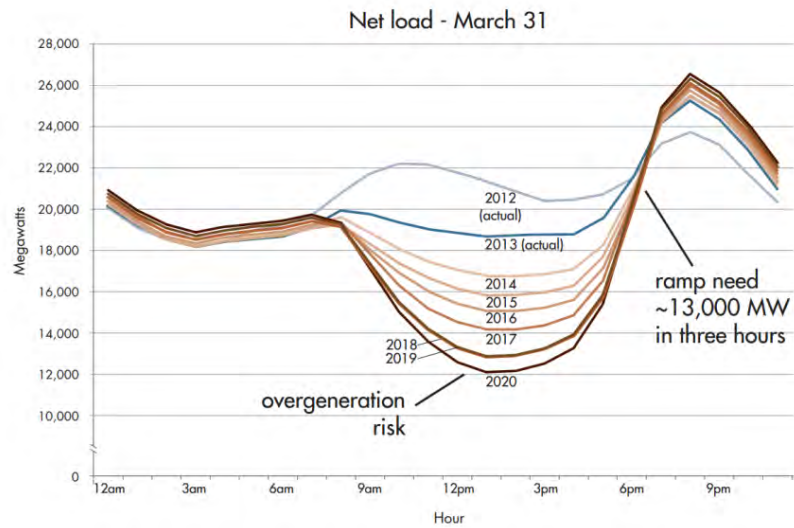

FIGURE 1.3: Duck curve effect. Source: [21]

Chapter 2

Basic Concepts and Enabling Technologies

2.1 The power grid

A power grid is a network of producers, consumers and the infrastructure that connects them. The producers supply electricity to the grid while consumers draw electricity from it. The network consists of nodes, which are the points of the network where generators inject power or consumers extract power, or branching points redistributing power. The links between the nodes are electrical connections and they can represent transmission lines or transformers. These components of the grid are constantly changing both due to variations in supply and demand but also due to disturbances that may occur[22].

2.1.1 Power Flow Problem

The structure of the network can be represented by the complex-valued admittance matrix Y_0 , using the standard approach in which we can represent transmission lines and transformers in terms of equivalent admittances [23]. Y_{0ij} is the negative of the admittance between nodes i and j where $j \neq i$, while Y_{0ii} is a diagonal element of the matrix and is the sum of all admittances connected to node i .

In an alternating current grid, power is represented by a complex number $P_i + jQ_i$ where P_i and Q_i are active and reactive power respectively. The state of the power grid can be characterized by the complex voltage V_i and the complex power $P_i + jQ_i$ injected into each node i in the network. Given the network topology and the parameters of the power generators and loads, Kirchhoff's laws can determine the power flow state of the system. Steady-state power system analysis is based on the so called power flow equations:

$$P_i = \sum_{j=1}^n |V_i V_j Y_{0ij}| \sin(\phi_i - \phi_j - \gamma_{0ij}) \quad i = 1, \dots, n$$

$$Q_i = - \sum_{j=1}^n |V_i V_j Y_{0ij}| \cos(\phi_i - \phi_j - \gamma_{0ij}) \quad i = 1, \dots, n$$

where the complex admittances are represented in polar form as $Y_{0ij} = |Y_{0ij}| e^{j\alpha_{0ij}}$, $\gamma_{0ij} := \alpha_{0ij} - \pi/2$, and n is the number of nodes.

The objective of the Power Flow Problem is to determine the set of variables (P, Q, V, ϕ) at every node of the topology.

In order to solve this set of $2n$ nonlinear equations for all $4n$ quantities that determine the power flow state we make the following assumptions:

- For generator nodes, the values of active power P_i and voltage magnitude $|V_i|$ are specified as known parameters while reactive power Q_i and voltage angle ϕ_i are to be resolved. This assumption is made because generators are considered to be scheduled to produce constant active power at a given time, and voltage magnitude is usually maintained by voltage regulators. These nodes are called PV nodes.
- One generator node is chosen to be a reference node. For this generator, instead of specifying P_i , ϕ_i is set to zero. This node supplies the losses to the network and it is called the slack node.
- For load nodes, the values of P_i and Q_i are given as known parameters. These values can be determined from historical data analysis, prediction algorithms or other methodologies. These nodes are called PQ nodes.

There exist significant research efforts concerning the power flow equations regarding their mathematical modeling and associated computational approaches. The detail presentation of these efforts is beyond the scope of this study.

2.1.2 Optimal Power Flow

The solution of the above described power flow problem gives a snapshot of the system. It describes the way the lines in the system are loaded, what the voltages at the various buses are, how much of the generated power is lost and where limits are exceeded[24]. This snapshot, no matter how useful, it is not enough for planning and operating a power grid. These tasks often ask for adjustments according to certain criteria. An example is the adjustment of generated powers in order to achieve the minimum generating cost. In this case both the voltages at nodes where the loads are supplied must be determined as well as the input powers together with the corresponding voltages at the generator nodes. The aim of the optimal power flow is the same with the power flow, the determination of the nodal voltages in the system but this must be done in presence of an objective while respecting the limits of the input variables.

The input variables must be kept within required bounds that should not exceed for a stable, secure operation [24]. Specifically we have:

- Limits on active power of a PV node (generator k) :

$$P_{low_k} \leq P_{PV_k} \leq P_{high_k}$$

- Limits on voltage of a PV or PQ node :

$$|V|_{low_i} \leq |V|_i \leq |V|_{high_i}$$

- Limits on voltage angles of nodes :

$$\phi_{low_i} \leq \phi_i \leq \phi_{high_i}$$

- Limits on voltage angles between nodes :

$$\Phi_{low_{ij}} \leq \Phi_i - \Phi_j \leq \Phi_{high_{ij}}$$

- Limits on reactive power generation of a PV node (generator k) :

$$Q_{low_k} \leq Q_{PV_k} \leq Q_{high_k}$$

- Upper limits on active power flow in transmission lines :

$$P_{ij} \leq P_{high_i}$$

- Upper limits on MVA flows in transmission lines :

$$P_{ij}^2 + Q_{ij}^2 \leq S_{high_{ij}}^2$$

- Upper limits on current magnitudes in transmission lines :

$$|I|_{ij} \leq |I|_{high_i}$$

The objective function of the optimal power flow problem sets the goal of the power system's next state. Indicative types of the objective functions are the following[24]–[26]:

- Cost Objective or Economic Dispatch
- Voltage Deviation Objective
- Loss Objective
- Security-Constrained Economic Dispatch
- Security-Constrained Unit Commitment

2.2 Electricity Markets

Electricity is the commodity traded in electricity markets. However, electricity is a special good due mainly to the following reasons:

- Physical constraints, i.e. the laws of Kirchhoff demand that power supply equals power demand at all times and in all network nodes, as already mentioned in section 2.1.
- Electricity cannot be stored yet, at least in large enough quantities, for long periods and in a cost efficient manner.
- Inelastic demand, to a large extend.
- There exist high stochasticity from both supply and demand sides.
- Various generation technologies

Electricity market restructuring started with the aim of eliminating obstacles for wholesale electricity competition. The general problem, deregulated energy markets are trying to solve, is how you provide open access without discrimination to the natural monopoly of the transmission grid. This monopoly can be further analyzed into two other monopolies, the ownership of the infrastructure(the wires) and the coordination and system operation.

The specific features of electricity listed above together with open access and non-discrimination principles, pose design constraints in the electricity markets.

What characterizes an electricity market design as efficient is the acknowledgment of the crucial engineering characteristics of the power grid, the efficient operation of the grid and the utilization of prices and incentives that further boost this efficient operation and are consistent with it.

Electricity market restructuring starts in the 1980s in Chile [27] while in the United States it starts with the Energy Policy Act of 1992. An important step for the evolution of these markets is the publication of [28] that developed pricing methods for electricity. [28] presents an efficient dispatch and pricing model, where prices at each location on the grid reflect the marginal cost of serving one additional unit of demand at that location.

Most electricity market today in the United States, in order to provide long and short-run efficiency organize the real-time spot market around the principles of *bid-based*, *security-constrained*, *economic dispatch with the associated locational prices*[29]. These principles will be further analyzed in the next sections where the main design elements of electricity markets will be outlined. The implementation of these elements differs from country to country, or even within the same country where multiple electricity markets operate.

2.2.1 Economic Dispatch

Figure 2.1 illustrates a dispatch curve. This curve ranks generators based on their marginal cost of generation and the amount of power they can generate. X axis shows the system available capacity while the Y axis shows the the marginal price for the corresponding quantities. Generators that have lowest marginal cost are placed on the left bottom of the curve. As we move to the right on the X axis prices rise because generators with higher costs are added.

Q1, Q2 and Qmax in figure 2.1 is the amount of energy the system operator requests to meet demand in three different time periods. It is clear that as demand increases, more expensive generators must be used to meet this demand and as a result the price of energy rises.

With economic dispatch a social optimal generation mix is selected and generators recover their cost. Everyone pays or is paid the same price. In figure 2.2 an equilibrium-supporting market clearing is presented. Market clearing prices support the efficient outcome that maximizes the net social welfare. It must be noted that this structure assumes ease of entry and exit in the market. If generation mix is not socially optimal some generators will not fully cover their costs and they will be incentivized to exit the market, while others will gather profits incentivizing other generators with the same characteristics to join the market.

Unit commitment is the process of deciding when and which generating units at each power station to start-up and shut-down. This decision is mainly affected by operational constraints and non-convex costs. An example of operational constraint is the time needed for a generating unit to start producing and for non-convex cost, an example is the cost associated with the start-up procedure. In energy markets today there are various approaches on how unit commitment and economic dispatch are implemented. These approaches mainly differ on the extend to which decisions are centrally coordinated or decentralized.

The unit commitment and dispatch method is one difference between energy markets in Europe and United States. Most European energy markets operate using self-dispatch while most energy markets in U.S. use the centralized dispatch

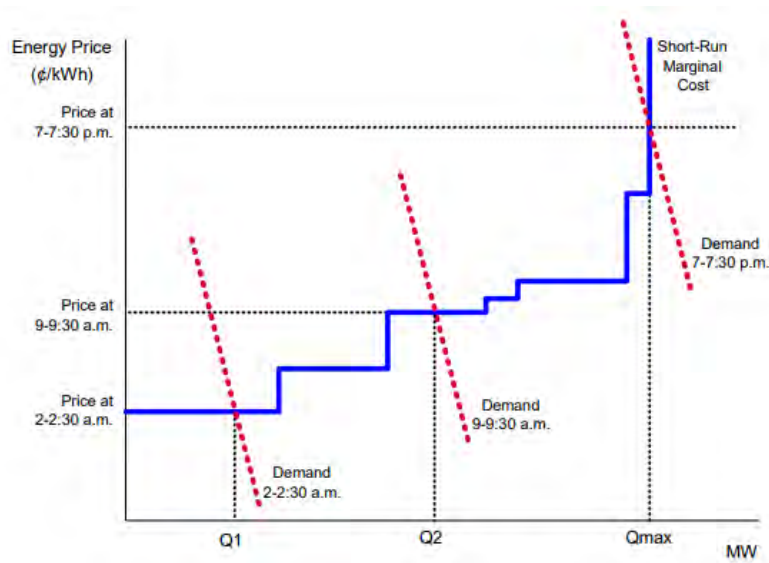

FIGURE 2.1: Dispatch Curve. Source: [30]

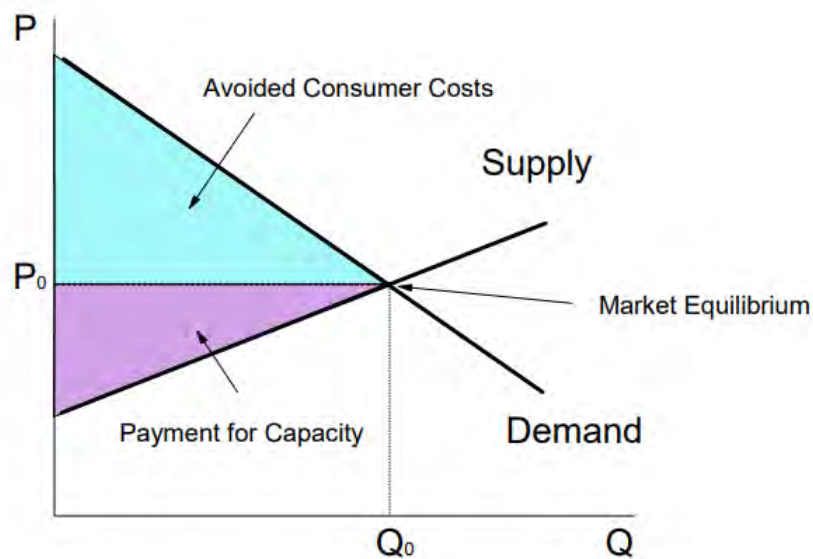

FIGURE 2.2: Energy Supply and Demand in a Complete Market. Source: [30]

approach. In the centralized design generators submit complex bids including their constraints and costs, like minimum, maximum capacity and marginal, startup cost. The market operator collects these bids and clears the market specifying the clearing price, commitment and dispatch for all the generators. In the decentralized design generators submit simple bids including price and quantity.

Coordination and efficient operation in the centralized design relies on the truthfulness of the submitted information. Such a market design allows bidders to submit deceiving information while trying to manipulate the outcome of the market. On the other hand in the decentralized operation generators decide on their own when to operate and at what levels which may lead to coordination problems that must be solved in the real-time balancing market[31]. Also, in the decentralized approach, generators submit bids after consideration for their non-convex costs, this fact may lead to submitting prices higher than their true costs.

Co-optimization is another characteristic that differentiates centralized and decentralized dispatch. Centralized markets co-optimize energy, reserves, and ancillary services. Decentralized markets execute the clearing for energy, reserves, and ancillary services separately. This fact may lead to inefficiencies because each generator independently must take a decision on its participation to these markets while the market operator of the centralized design executes the co-optimization problem.

2.2.2 Different Markets

Different types of energy markets operate in a sequential order, starting years before the delivery and ending after the actual delivery of energy. In the following sections, the different types of energy markets are presented. It is not compulsory that all of these markets exist in all restructured electricity markets. For example, there are energy only markets, like Electric Reliability Council of Texas (ERCOT) where capacity is not traded and investments are incentivized only by spot prices. On the other hand PJM Interconnection, which serves 13 states and Washington D.C. California, has a capacity system in place since 2007.

Forward, Future and Capacity Markets

A forward and future market runs years before the delivery until the day before the actual delivery of energy. Forwards and futures are contracts to generate or consume a certain amount of energy in a specific time in the future at a price agreed upon. Forward and future markets reduce vulnerability both for generators and large consumers. Generators, through these markets ensure future sales at specific prices and possible reduction of the energy price will not affect them. Accordingly, a large consumer can reduce its risk posed by a price increase[32].

Another issue that forward and future markets deal with is the capacity planning and investment[33], a problem usually encountered with the name *missing money problem*. For a number of reasons prices for energy in competitive wholesale electricity markets may not fully recover the total cost of investment in the resources needed to meet customers' demand and expectations for reliable services[34]. Moreover, a low-carbon power system may be more capital intensive compared to traditional power systems.

Some restructured electricity operate additional markets, called capacity markets, dedicated to feature payments for capacity in addition to day-ahead and real-time energy. These payments are typically forward contracts that last between one

and three years. The prices for these contracts are determined through an auction mechanism.

The purpose of the capacity market is to provide an additional revenue source to generators, as an added incentive for them to stay online and solve the missing money problem.

Day-ahead Markets

In the day-ahead market, electricity is traded 24 hours before actual delivery. The market clearing in a day-ahead market typically happens at midday of the day before the operating day. This market relies heavily on forecasts of demand and supply.

A day-ahead market is of great value, to a power system which relies to a big extent to thermal generators that have long start up times and cannot respond promptly to price changes. For example, nuclear power plants require multiple days' planning to start or stop producing while steam turbines can take more than six hours to startup. This market makes sure that generators with this kind of response characteristics will be available when their supply is needed by the system by providing commitment, dispatch, and price information[33].

However, in power systems with a high share of renewable energy sources, the day-ahead market may be of limited value[33]. Renewable energy sources are highly weather-dependent and the uncertainty deriving from weather predictions makes day-ahead markets not a fit for them.

Reliability unit commitment

The reliability unit commitment model is an additional market-clearing between day-ahead and real-time market. The unit commitment model is introduced in some countries, especially in the United States, and its purpose is to give system operator additional opportunities to provide system reliability. The reliability unit commitment model is solved during the evening of the day before delivery. It enables system operator to commit additional units if system conditions have changed in a way different than the forecasts indicated in the day-ahead market clearing. Settlements made by the reliability unit commitment model are paid using day-ahead and real-time prices[33].

Intra-day Markets

In some countries, including a number of European markets, electricity is traded also in intra-day markets. Trading in intra-day markets takes place during the day of delivery and these markets are placed in time between day-ahead and real-time markets. Intra-day markets enable their participants to correct their day-ahead schedules. These adjustments in the schedule may arise from unexpected events, such as outages, or from better forecasts as the time of delivery approaches[32].

Intra-day market and reliability unit commitment have a lot in common, as they are both placed between day-ahead and real-time markets and their main role is to provide stability and make adjustments on better forecasts. The main difference between them is that reliability unit commitment adjusts production and consumption schedule in a centralized way, while in intra-day markets participants adjust their schedules individually[33].

Real-time Markets

Real-time markets clear 1 hour to 5 minutes before the actual operating period. The main role of real-time markets is to balance the differences between commitments made in the previous markets and the actual real-time demand for and production of electricity as uncertainty is resolved. It is the last energy trading opportunity before the delivery. Real-time prices are more volatile compared to the clearing prices resulting from other markets. As the share of weather-dependent renewable energy sources increases the amount of energy traded in real-time energy markets increases too.

2.2.3 Demand-Side Participation

Electricity demand has been considered as highly inelastic especially in the short run. This is the reason why most of the attention during electricity market restructuring has been paid on creating mechanisms that coordinate supply and capacity. However, power systems today are going through demand side transformation as described in section 1.1. AMI, IoT and Smart Grid can result in a higher and more active participation of demand, either directly in energy markets or through programs such as demand-response. Active participation of demand is considered as a source of additional flexibility for the power system and can also contribute to lower electricity prices for final customers.

The term *Negawatt* refers to the amount of energy saved as a result of energy conservation or increased energy efficiency. It is a theoretical unit of power which was introduced in the article [35]. In [35] the author claims that in consumers do not care about the kilowatt-hours of electricity, instead they care about energy services. These energy services can be a warm house during the winter or a hot shower. These services can cost less if electricity is used more efficiently. However, the way of compensating an end consumer for providing a negawatt is not so straight forward [36].

A way of giving financial incentives to consumers are demand response programs. Demand response programs aim to incentivize consumers to reduce or shift their energy usage. These financial incentives may take various forms including time-based rates such as time-of-use pricing, critical peak pricing, variable peak pricing, real time pricing, and critical peak rebates. Some demand response programs may also include direct load control programs, in which power companies are able to directly control consumer's appliances and turn them on or off according to system needs, in return for financial benefit. The goal of these programs is illustrated in figure 2.3, demand response aims to shift load from peak periods to periods of low consumption, in order to maintain a flat load profile.

Direct participation in energy markets today is an option only for large commercial or industrial consumers. Small, residential consumers participate in energy markets usually through utility companies. In this way demand from residential consumers is not presented in energy markets today as being price responsive. The main reason why direct access of small consumers to energy markets is not given is that this would cause unmanageable market models [33]. However, this reason can be overcome today as computational capabilities advance.

2.2.4 Transmission System Representation

Currently there are two approaches in the representation of the transmission system in energy markets. The first one is the simplified zonal model and the second one

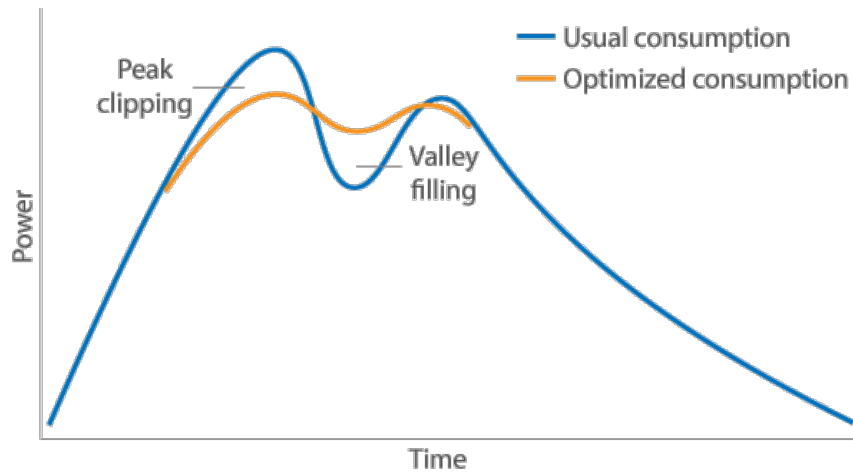

FIGURE 2.3: Optimized Consumption Using Demand Response.
Source: www.nwcouncil.org

is the nodal model which uses a more accurate representation of the transmission system. Both models are used to define the cost of transmission between two areas.

Zonal Representation

A bidding zone is a geographical area within which market participants are able to exchange energy without capacity allocation. The zonal representation of a power system is a simplified version of the physical transmission system, where only some of the transmission constraints are represented while others are characterized as insignificant and are neglected. The available transmission capacity may vary and congest the flow of power between bidding zones, in such a situation different prices are established in the different zones. Different zones may get different energy prices due to bottlenecks in the transmission system, however inside a zone there is only a single price.

Europe today uses the zonal representation for its energy markets, different bidding zones are illustrated in figure 2.4. In the model for the single European energy market the majority of the zones are defined by national borders, with very few exceptions. One exception is the case of Germany and Austria which are merged into one bidding zone. This merge is a result of the traditionally tight cooperation of the two countries and the strong interdependence of their respective grids¹. Another exception are the Nord Pool markets that are divided into several bidding areas where Sweden, for example, is divided into four bidding areas. There is a historical reason that justifies this market-design choice. This reason is that when restructuring of energy markets started in Europe, most of its power systems had over-capacitated transmission systems and transmission constraints rarely occurred[33].

A debate is currently taking place in Europe for the efficiency of European bidding zones.

Nodal Representation

In the nodal representation of the transmission grid each node of the system is represented in the energy market implementation and a price is determined for each

¹<https://www.tennet.eu/electricity-market/german-market/congestion-management/market-based-congestion-management/>

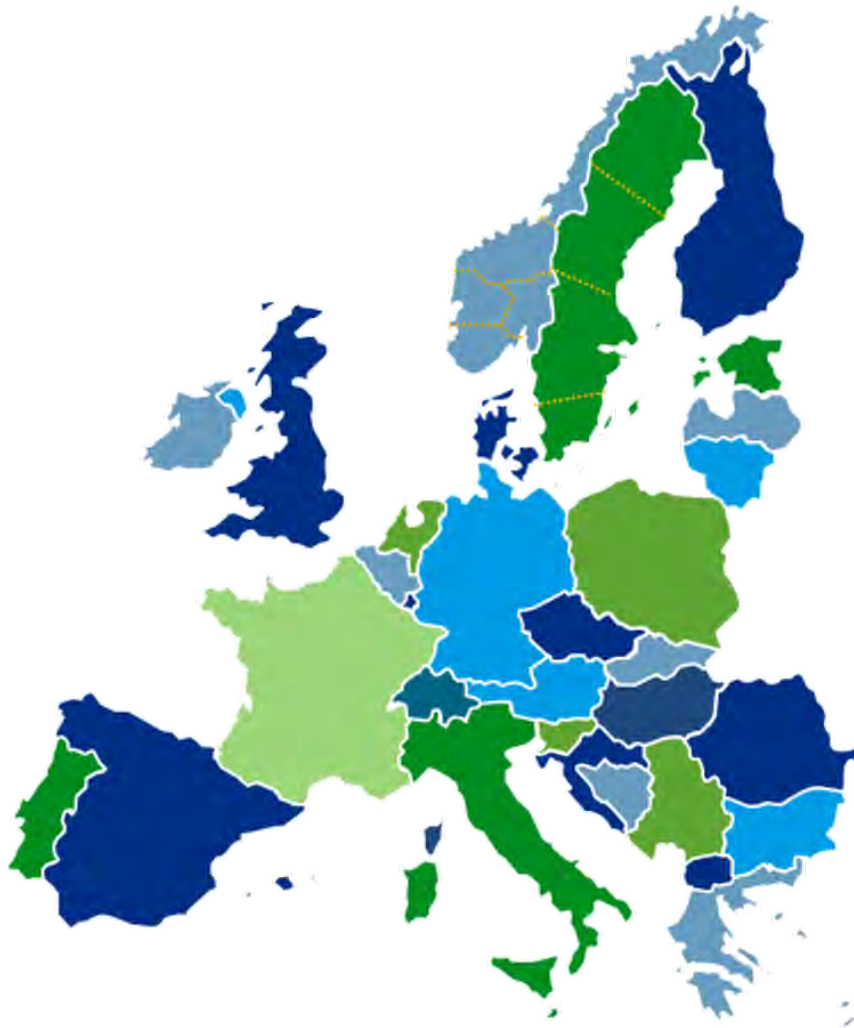

FIGURE 2.4: European Bidding Zones. Source: www.tennet.eu

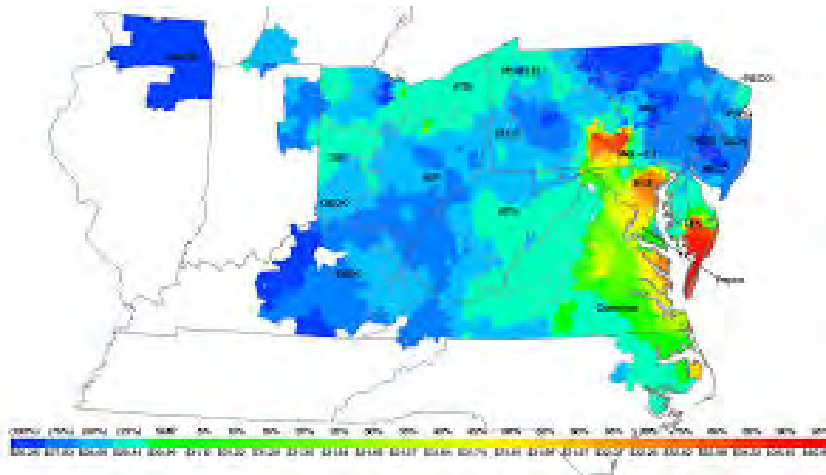

FIGURE 2.5: Locational Marginal Prices in PJM Region. Source: www.pjm.com

locations of the transmission grid. In other words, in the nodal representation of the transmission system, each node of the system is defined as a different zone.

All of the restructured markets in the United States have implemented the nodal representation of the transmission system [33]. In figure 2.5 we see the different locational prices through out the area operated by PJM.

The difference in the locational prices at source and destination is the amount of money that must be paid for short-term transmission usage.

2.2.5 Challenges

The main challenge energy markets face today is that large scale thermal generation, with relatively high short-run operating costs, will be replaced by capital intensive but low or zero variable cost resources. This transformation of the grid makes distributed demand participation ever more important in managing overall system balance and security[30].

Some of the extensions, proposed in the literature[30], [33], for the next generation energy markets include:

- Virtual bidding
- Multi-period bidding
- Extended Locational Marginal Prices
- Representation of uncertainties
- Representation of physical constraints
- Representation of production facilities
- Active demand-side participation

2.3 Data Analytics

There are four types of data analytics, all of them aiming to improve decision-making, but each one in a different way.

Descriptive Analytics Answers the question: *What happened?* Descriptive analytics utilize data aggregation and data mining methods to provide insights into the past. Querying, reporting and data visualization techniques are also used.

Diagnostic Analytics Answers the question: *Why something happened?* Diagnostic analytics use data to understand the causes of events and behaviors by finding dependencies and identifying patterns.

Predictive Analytics Answers the question: *What is likely to happen?* Predictive analytics use statistical models and forecasts techniques to understand the future. Using the findings of descriptive and diagnostic analytics, predictive analytics provide actionable insights based on data.

Prescriptive Analytics Answers the question: *What action to take to avoid a future problem?* The aim of prescriptive analytics is to quantify the effect of a future decision and provide advise on possible outcomes. This is achieved using business rules, algorithms, machine learning and computational modelling procedures based on historical and transactional data, real-time data streams, and big data.

In the current work we will focus on predictive analytics, which will be presented in the next section.

2.3.1 Predictive Data Analytics

The purpose of predictive data analytics is to build and use models that are able to make predictions based on patterns extracted from historical data. This is achieved using a variety of statistical techniques.

The key phases that constitute a predictive data analytics process are the following:

Business Understanding: Understanding of the problem to be addressed and definition of the objective.

Data Understanding: Identification of the multiple data sources and understanding of the data they provide.

Data Preparation: Inspecting, cleaning and organizing data so as to discover useful information.

Modeling: Creation of accurate predictive models. This phase may include building a range of models using different algorithms and selecting the best fitting model.

Evaluation: Running of the evaluation tasks required to prove that the model build can make accurate predictions after being deployed. During this phase, we make sure that the model does not suffer from overfitting or underfitting.

Deployment: This phase includes all the work that must be done to integrate the model built into the existing process.

The above described phases do not happen in a strict sequential order, rather the whole process may involve moving back and forth between these phases, as illustrated in figure 2.6.



FIGURE 2.6: Predictive data analytics process. Source: [37]

The Business Understanding, Data Understanding, and Data Preparation phases result in a set of descriptive and target features expressing domain concepts. Features can be both *raw features*, that come directly from data sources and *derived features*, that are the result of manipulating values from data sources. Domain concepts must be available to the modeling task embracing the various aspects of the scenarios that will be used.

The Modelling face includes the machine learning process, an automated process that extracts patterns from data. Machine learning types include supervised learning, unsupervised learning, semi-supervised learning, and reinforcement learning[38].

- Supervised learning uses labeled training examples to learn relationship between a set of descriptive features and a target feature.
- Unsupervised learning concerns the analysis of unclassified examples.
- Semi-supervised learning uses mainly unlabeled data, while a small amount of labeled data are used to improve the learning accuracy.
- Reinforcement learning collects feedback from environment to discover the most rewarded action in a trial-and-error process.

In the current work we will focus on supervised machine learning method, a method used to train models to make predictions using sets of historical examples.

These historical examples, or training instances, include descriptive features and the target feature. The machine learning algorithms capture the relationship between the descriptive features and the target feature and build a generalized model. The information that guides the machine learning algorithm to find the prediction model that best generalizes beyond the training dataset is the inductive bias assumed by the algorithm.

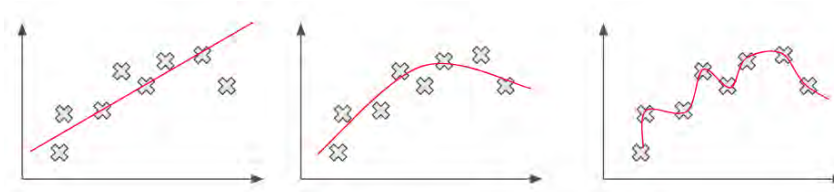

FIGURE 2.7: Underfitting on the left, Optimal and Underfitting on the right

Inappropriate inductive bias can lead to either overfitting or underfitting. Overfitting is the case when the prediction model fits too closely to the training data set. Overfitting results in a prediction model too sensitive to noise in the data. On the other hand, underfitting is the result of a too simplistic prediction model that fails to represent the underlying relationship between the descriptive features and the target feature in the training dataset. The problem of overfitting and underfitting is illustrated in figure 2.7.

Machine learning algorithms can be classified into four families:

Information-based Learning: concepts of information theory are employed to build prediction models. The structure mainly used in this family of learning algorithms is decision trees and ID3 is a widely used algorithm to produce decision trees from training datasets.

Similarity-based Learning: the main idea behind this approach is that the best way to make a prediction is to look what has happened in the past and predict the same thing. Feature spaces and measures of similarity are fundamental concepts when building models based on this idea. Data normalization and feature selection techniques are especially important in similarity-based learning. The nearest neighbor algorithm is the standard algorithm in this approach.

Probability-based Learning: is based on Bayes' Theorem: *"the probability that an event has happened given a set of evidence for it is equal to the probability of the evidence being caused by the event multiplied by the probability of the event itself"*. Naive Bayes model is the standard approach when using probability-based approaches to machine learning.

Error-based Learning: a search for a set of parameters for a parameterized model is performed. These parameters must minimize the total error of all the predictions made by the model built with respect to a set of training instances. Multivariable linear regression with gradient descent is the standard approach in building error-based predictive models.

For a more detailed presentation of predictive data analytics, the reader is referred to [37] and [39].

2.4 Game Theory

Game theory according to some scientists² could also be called the theory of social situations, giving an accurate description of what game theory is about. Game theory classifies the games into two branches, the non-cooperative and the cooperative

²<http://www.dklevine.com/general/whatis.htm>

ones. Non-cooperative theory could be better stated as procedural, while cooperative as combinatorial. Non-cooperative game theory mainly focuses on how individual players interact with one another in an effort to achieve their own goals. In cooperative games the outcome depends on the combinations players make when they collaborate. The current work focuses on non-cooperative game theory.

2.4.1 Nash Equilibrium

The Nash equilibrium, is a proposed solution of a non-cooperative game and it has the advantage of existing in a broad class of games.

A Nash equilibrium is a set of strategies in which each player's strategy is an optimal response to other players' strategies. Nash equilibria are consistent predictions of how a game will evolve, because if all players predict that a particular Nash equilibrium exists then no player has the incentive to play differently.

Every game in strategic form can be described by three elements,

- the set of players $i \in I$, which we consider to be a finite set $\{1, 2, \dots, I\}$.
- pure-strategy space S_i for each player i .
- payoff functions u_i that give player i 's utility $u_i(s)$ for each profile $s = (s_1, s_2, \dots, s_I)$ of strategies.

A pure strategy s_i is a completely specified strategy, defining how player i will play a game. A mixed strategy σ_i is a probability distribution over pure strategies. s_{-i} and σ_{-i} denote a strategy selection for all players but i , of pure and mixed strategies respectively.

A mixed-strategy profile σ^* is a Nash equilibrium if, for all players i ,

$$u_i(\sigma_i^*, \sigma_{-i}^*) \geq u_i(s_i, \sigma_{-i}^*) \quad (2.1)$$

A pure-strategy profile s^* that satisfies the same conditions is a pure-strategy Nash equilibrium.

A Nash equilibrium is strict, if every player has a unique best response to other players' strategies. In mathematical form, s^* is a strict equilibrium if it is a Nash equilibrium and for all i and all $s_i \neq s_i^*$

$$u_i(s_i^*, s_{-i}^*) > u_i(s_i, s_{-i}^*) \quad (2.2)$$

A strict equilibrium is always a pure-strategy equilibrium[40]. Nash equilibrium is not necessarily Pareto optimal.

2.5 Distributed Ledger Technology

A distributed ledger is a database that is shared across a network. Each node of this network can have its own replica of the ledger. Entries of this database can be changed according to the rules agreed by network participants and any change to the ledger is reflected to all copies of the ledger across the network. Entries are secured cryptographically through asymmetric cryptography[41].

Distributed ledger technology is the underlying technology of blockchain. Blockchain is distributed digital ledger organized in a cryptographically secured, tamper-proof and always increasing chain of blocks. An other implementation of distributed ledger technology is Directed Acyclic Graphs(DAGs), in which the entries of the ledger are organized using a graph structure.

2.5.1 Blockchain

History

Blockchain is not a new idea as it already counts at least two decades of existence. The idea of cryptographically secured chain of blocks was initially introduced in [42], a work from Stuart Haber and Scott Stornetta, where a method of secure time-stamping documents is described. The goal of this work was to time-stamp documents in order to give an approximation of the time documents were created and a sequential ordering among them.

In [42] authors designed a time-stamping service to which digital documents are sent to be certified. This certificate contains a signature from the service together with a pointer to the previous document and the time-stamp. The pointer to the previous document is the output of a hash function. Using this method, a chain of documents is created (figure 2.8), where each document certifies the integrity of the previous and the relative ordering of the documents is ensured. This method is secure because the time-stamp of a document is ensured by the next document so it cannot be changed after it is assigned.

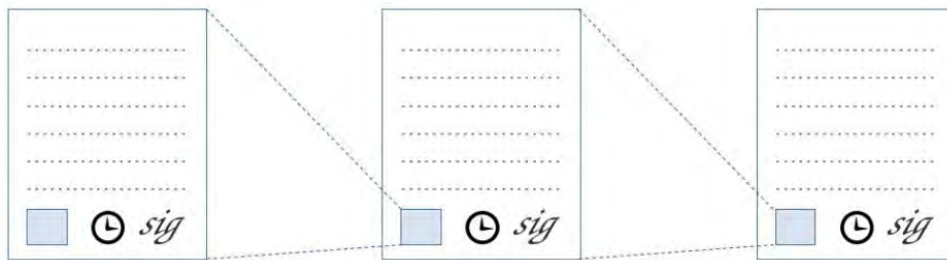

FIGURE 2.8: Cryptographically Secured Chain of Documents. Source: [43]

A proposal on the efficiency of the secure digital time-stamping method came a year later with [44]. [44] introduces the block of documents linked in a chain. The documents inside a block are organized in a tree structure, known as Merkle tree and illustrated in figure 2.9. This tree structure improved the efficiency of time-stamping method by collecting in one block multiple document certificates. In the structure depicted in figure 2.9, blocks are linked together forming a linear chain while inside each block documents are connected in a tree structure. The time-stamping of the documents now happens at the level of the block.

What Satoshi Nakamoto introduced in this method, with his famous whitepaper [45] for Bitcoin, is the decentralization. In [42] and [44] a trusted service assigned the time-stamps to the documents and the blocks. In the new decentralized approach

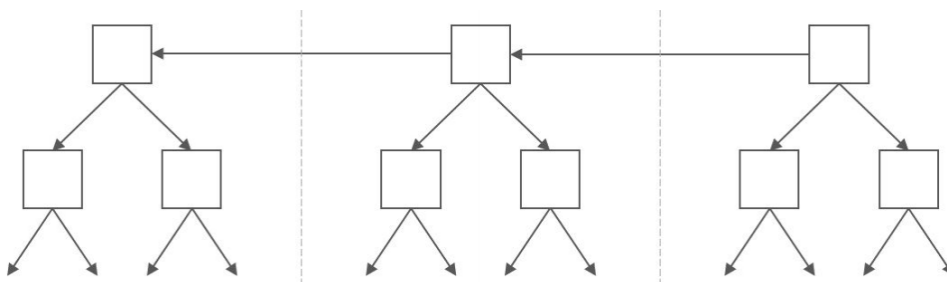

FIGURE 2.9: Cryptographically Secured Chain of Blocks Source: [43]

blocks are added in the chain using a hash-based Proof-of-Work, relying on a P2P network and without the need of a trusted third party.

Bitcoin combines the idea of using computational puzzles to regulate the creation of new currency units with the idea of secure time-stamping to record a ledger of transactions and prevent double-spending[43]. Double-spending problem is solved by maintaining a chain of blocks, keeping all the transactions in order of time. The chain is maintained by a distributed P2P time-stamp server generating computational proofs. As long as, more than 50% the computing power of the network is controlled by honest nodes, this distributed system is considered secure. Every time a computational proof is generated by a node of the network, new coins are created and assigned to this node.

The process of transaction validation and consolidation on the state of the ledger, is called consensus algorithm and varies for different types of blockchains. Proof-of-Work is the consensus algorithm introduced by Satoshi Nakamoto and is widely used by blockchains nowadays. However, Proof-of-Work is not the only consensus algorithm. Section 2.5.3 gives an overview of some of the consensus algorithms that exist today.

How It Works

This section describes the blockchain protocol from the time an account generates a transaction to the time this transaction is added inside a block and the block is added to the chain. There are differences between each implementation of the protocol that derive from the different development purposes. Bitcoin is an example of a blockchain designed for cryptocurrency transactions, while Ethereum is a general purpose blockchain designed to accommodate a wide range of use cases and distributed applications. The listing and description of these differences in the implementations is beyond the scope of this thesis and the reader is referred to the whitepaper of each implementation.

Blockchain protocol consists of the following steps:

1. A new transaction is created.
2. The transaction is broadcast to the network.
3. Nodes receive the new transactions and place them into their transaction pool.
4. Nodes create blocks including pending transactions from their pool.
5. The block is broadcast to the network.
6. Nodes validate the transactions included in the block they receive and accept it only if all transactions are valid.
7. Nodes use the hash of the accepted block to create the next block of the chain.

In order to perform a transaction, an account needs a unique pair of a public and a private key. This method of asymmetric cryptography ensures that coins can be sent to public keys, while coins assigned to a public key can be spent only by knowing the corresponding private key. The public key is referred to as the address of the account. A new transaction is created by an account, specifying some attributes including the amount of coins to be sent and the address at which the coins will be assigned. This transaction is signed by the sender. The digital signature is a piece

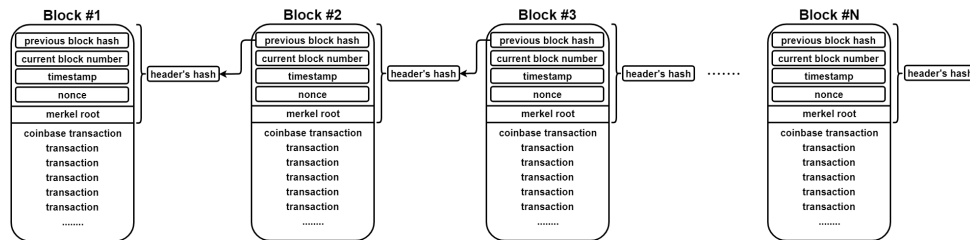

FIGURE 2.10: Blockchain

of text resulting from the encryption of the hash of the transaction request using sender's private key.

The digitally signed transaction is publicly announced to the network. To announce a transaction to the network, an account must have access to a node connected to the P2P network of nodes.

Nodes receive the transaction and relay it to their neighbors. The nodes that receive the transaction can verify that the account spending the money is the account sending the transaction by decrypting the transaction using the public key of the account spending the money. Valid transactions received by a node are added to a pool of pending transactions. Transactions from the pool, together with a special transaction called the coinbase transaction, are added in a new block. Additional properties that constitute the block header are specified. These properties include a hash of the previous block, the root of the merkle tree of the transactions, a timestamp and others (see figure 2.10).

When a node creates a block, it sends it to the other nodes of the P2P network. The nodes that receive the block validate both the header properties and the transactions included in it. If everything is valid, nodes add the block to their local copy of the blockchain. As soon as the new block is added to the chain, nodes start building the next block with the transactions that have arrived until that time in their pool. Nodes express their acceptance of the new block by using its header's hash as the previous hash in the new block they are trying to build. The very first block of a blockchain is called the genesis block, it is the only block which does not reference a previous block.

The coinbase transaction, is a transaction that creates new coins that belong to the account that created the block. The existence of this transaction has been added to the blockchain protocol for two reasons. The first reason is that it provides incentives to the nodes to support the network by committing their computing power to mine new blocks. The second reason is that it implements the initial distribution of the circulating coins. Apart from the new coins issued, the block creator receives also the transaction fees. The sender of a transaction, when building a transaction, sets an amount of cryptocurrencies as transaction fees. When the block creator, gets the transactions from the pool to pack them in the block, the transactions are ordered in a descending list considering their transaction fees. The higher the transaction fees, the sooner the transaction will be included in a block.

2.5.2 Access Rights

Depending on the use of the blockchain, one might want to restrict the access permissions to it. Rights to update or even read the blockchain can vary from being completely open to being restricted to one user. In each case the guarantees of authenticity and decentralization the blockchain provides is different.

Public blockchains are considered to be fully decentralized. The security of a public blockchain is guaranteed by the economic incentives and the cryptographic verification originating from the protocol. Anyone can join a public blockchain network and read all the blocks and transactions included in them since the genesis block. Anyone can send a transaction over a public blockchain and see it included in a block if it is valid. Anyone can update the blockchain by creating blocks according to the rules of the consensus algorithm used by the specific network.

Private blockchains are blockchains whose write permissions are assigned only to one entity, usually an organization. Only this entity creates the blocks and controls the transactions included. Read permissions can also be restricted depending on the application needs. Private blockchains are considered to be the most centralized compared to public and consortium.

Consortium blockchains are blockchains where the nodes that generate new blocks are predetermined. The requirements for a block to be considered as valid can vary, an example could be that a block must be signed by the majority of the predetermined nodes in order to be added in the chain. Read access can be public or restricted to participants.

2.5.3 Consensus Algorithms

Consensus algorithms involve a procedure for generation and acceptance of a block from and by the network nodes. A number of different algorithms exist today, with each one having its own advantages, disadvantages and special features. Consensus algorithm plays a significant role in the performance characteristics of a blockchain. These characteristics include scalability, transaction speed, transaction finality and security [46], [47].

Proof of Work (PoW)

In the PoW algorithm the role of the miner exists. The miner is the node that works to create new blocks. The PoW algorithm requests that the hash output of the new block's header starts with a number of zero bits. The miner, in order to achieve this, scans for a value, that when included in the block header the result of the hashing will give the requested number of leading zeros. This value is called *nonce*. The average amount of work required to find the nonce is exponential in the number of zero bits required. Miners have no way to predict or influence the outcome of the hashing algorithm and the way to find a nonce that fits the requirements is through trial and error approach. On the other hand, the verification that a nonce is compliant with this request, needs the execution of a single hash. Nodes are independently competing to solve these hash puzzles all the time. When a miner finds the nonce that gives the number of leading zeros needed, generates the block and broadcasts it to the network. Nodes express their acceptance of the new block by using its header's hash as the previous hash in the new block they are trying to build.

PoW is currently used by Bitcoin, Ethereum, Litecoin and others.

The main downside of PoW is the large amounts of energy consumed by the network.

Proof of Stake(PoS)

PoS came as an alternative to PoW, trying solve its main problems and especially the electricity consumption[48].

Unlike in PoW, in PoS the mining process does not exist, the search of the right *nonce* is not required. PoS includes only the validation phase and the nodes that perform the process of validation are called validators. In the PoS algorithm, the chances of successfully generating the next block are proportionally related to a validator's economic stake in the network, instead of being proportional to the amount of work performed by the miner.

In PoS, a set of validators is maintained and any node, holding an amount of the blockchain's base cryptocurrency, can become a validator. In order to become a validator, a node has to send a special transaction locking up its coins into a deposit.

Starting from a consensus point, that is, a block already added to the chain, the PoS algorithm randomly selects a validator and gives it the right to create the next block. The higher the security deposit from a validator, the higher is the probability to be selected to create the next block. Other validators then vote on the block and cast their votes to the network. As validators receive votes from other validators, they eventually end up in a consensus for the next block. The PoS incentive mechanism is such that validators earn rewards when they vote for consensus and lose their deposit when they vote against consensus. Thus, any malicious validator trying to cheat the network and vote for a block with invalid transactions loses his deposit and voting rights[49].

Compared to PoW, PoS can potentially result to reduced electricity consumption, reduced centralization risks and decreased likelihood of 51% attacks as they become vastly more expensive[48].

The main vulnerability of PoS is known as the *nothing at stake* problem. In the case that there are multiple chains in the blockchain, validators are incentivized to try to make blocks on top of every chain at once as it is inexpensive for them. In PoW, such a behavior would mean splitting one's computing power in all the different chain, a choice that would no be profitable. Several solutions to this problem have been proposed, mainly focusing on punishment mechanisms like deducting coins owned or deposited.

Ethereum is the most popular blockchain platform that plans to move from PoW to PoS consensus in its public blockchain.

Delegated Proof of Stake(DPoS)

In DPoS the roles of *witnesses* and *delegates* are defined. In DPoS systems, users vote to select *witnesses* and *delegates*. In this voting procedure votes are weighed according to the size of each voter's stake. This means that users do not need to own a large stake to become *witnesses* and/or *delegates*.

Witnesses validate transactions and create blocks, and in return they are awarded the associated transaction fees. Each witness, when elected, is assigned a fixed schedule to produce a block, for example every 2 seconds. This deterministic selection of block producers results in fast confirmation times[46]. A witness can be replaced at anytime by another user who gets more votes, meaning that he is considered more trusted. For an elected witness, threat of loss of income and reputation is the primary incentive against malicious behavior.

Delegates are responsible for the governance and performance of the network. Delegates are not involved in transaction validation and block production. Delegates are elected, as witnesses, but their role is to propose changes on protocol rules and system parameters. Subsequently, blockchain users vote on whether these proposals will be adopted. Proposals can include changing the size of a block, the number of transactions per block or the amount a witness should be paid in return for validating a block. Most blockchain protocols have their rules and parameters programmed into the genesis block. Voting is a continuous process not only for witnesses but for delegates too.

The main problem DPoS faces is the large centralization risk involved in the case that the participation of the nodes in the election process is low.

Proof of Authority(PoA)

PoA consensus algorithm requires granting special permission to number of nodes in order to generate new blocks. Network members put their trust into these authorized nodes, explicitly allowed to create new blocks and secure the blockchain. A new block is accepted if the majority of authorised nodes signs the block. A voting procedure is used to maintain the set of authorized nodes, through this procedure authorized nodes can be replaced or new nodes can become authorized.

According to its supporters, for consortium blockchains there are no disadvantages of PoA network as compared to PoW or PoS. PoA is more secure, less computationally intensive, more performant since it provides lower transaction latency and more predictable as blocks are issued at steady time intervals.

The main disadvantage of PoA consensus mechanism is that it represents a more centralized approach. However, it is very popular in the use cases where security and integrity cannot be put at risk[46].

Byzantine Fault Tolerance(BFT)

There is a classic problem in distributed computing first described in [50]. The problem involves several Byzantine generals who must take a joint decision on whether or not to attack a city they have surrounded. The difficulty comes from the fact that messages sent can be lost and some of the generals may be traitors sending false messages. The challenge is, to ensure that loyal generals can reach consensus on the attack plan, and a small number of traitors should not cause them to adopt a bad plan.

In the blockchain concept, traitors are malicious or unreliable nodes that try to characterize bad blocks or transactions as valid, while the rest of the network tries to reach a decision on which block should be added to the chain.

In the terminology of blockchains, a small number of unreliable or potentially malicious nodes should not be able to cause the validation of a bad block/set of transactions.

There are several versions of BFT, including *Practical Byzantine Fault Tolerance* and *Federated Byzantine Agreement*

Practical Byzantine Fault Tolerance(PBFT) In [51] authors proposed the first practical approach to face BFT. They called this approach Practical Byzantine Fault Tolerance. PBFT is the approach used by most of the blockchain systems using the voting-based consensus approach. In PBFT transactions are individually verified

and signed by known validator nodes. This characteristic makes PBFT more suitable to be used in trusted environments rather than public permissionless ledger applications. When a sufficient amount of signatures is collected, transactions are considered valid and consensus is reached. Verified blocks in PBFT cannot be reversed, providing in this way instant finality. PBFT provides guarantees for the operation of the network if the number of malicious nodes is not more than $1/3$ of the total number. Currently PBFT is in use by Hyperledger Fabric and Tendermint.

Federated Byzantine Agreement(FBA) FBA is another approach facing Byzantine generals problem. In FBA, nodes rely on a small set of validators(generals) that each node considers trustworthy. Nodes accept transactions that come from their trusted validators. Every node is responsible for its own chain and sorts messages as they are received. Two cases that use FBA are Stellar and Ripple currencies. These currencies use a voting procedure where validators vote if a set of transactions is considered valid. The process is repeated until a set of transactions receives a percentage of the total votes that is defined as sufficient. In Ripple, validators are pre-selected by the Ripple foundation, while in Stellar, anyone can be a validator so every node chooses which validators to trust.

Proof of Elapsed Time(PoET)

In PoET every validator, who wants to build the next block, requests a waiting time from a trusted function. The validator who was assigned the shortest waiting time, when this time passes, is elected the leader and creates the new block. The trusted function verifies that the timer was created by a Trusted Execution Environment(TEE). If the timer has expired, it can verify that validator did, in fact, wait the assigned time before claiming the leadership role. In the PoET algorithm, the chances of being elected as leader are proportionally related to a validator's resources contributed, where resources are general purpose processors with a TEE.

The current implementation of PoET by Hyperledger Sawtooth builds on a TEE provided by Intel's Software Guard Extensions (SGX).

Proof of Capacity(PoC)

In the PoC algorithm, the chances of successfully generating the next block are proportionally related to the hard drive space a validator has committed. Variations of PoC include proof of storage and proof of space. PoC uses plots, large datasets generated by the algorithm, occupying storage space. The problems that PoC needs to address are similar to the 'nothing at stake' problem.

2.5.4 Smart Contracts

The second stage of development, usually referred as *Blockchain 2.0* includes smart contracts. Smart contracts allowed blockchain technology to go beyond cryptocurrency applications. Smart contracts are programs that determine the rules of writing in the ledger and can be deployed on a blockchain with a Turing-complete language.

The key feature of smart contracts is that they provide trustless execution. In other words, they can execute a predetermined action if some conditions, that were agreed upon, are met. An example explaining this execution includes two parties, the first agrees to send an amount of money to the second if some conditions are true, without giving either party the ability to back out.

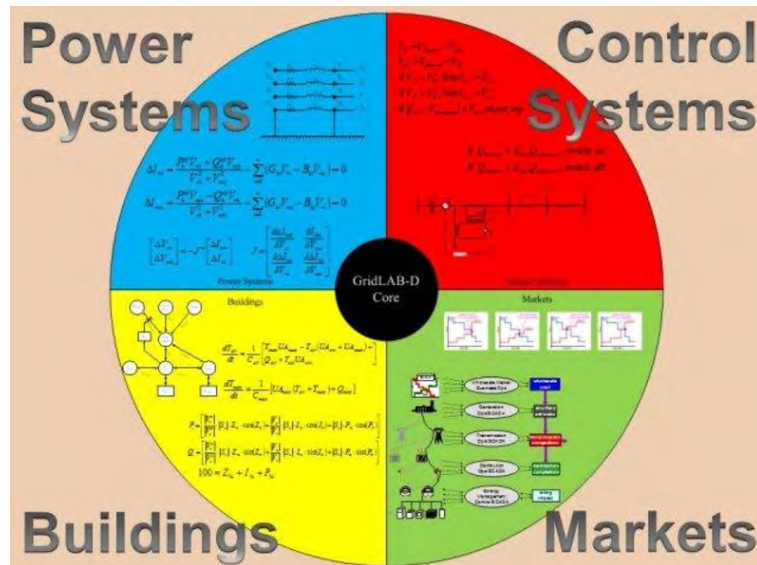

FIGURE 2.11: GridLAB-D Architecture. Source: <https://sourceforge.net/projects/gridlab-d/>

A smart contract, deployed on a blockchain, consists of the smart contract code and its current state. The contract state stores the values of the variables that are defined in the code. The smart contract layer is responsible for validating and processing transactions by executing the business logic specified in the contracts code.

2.6 Software Systems

To cover the experimentation and simulation needs of this dissertation three types of software systems were needed, a power grid simulation platform, a data analytics platform and a blockchain client. To cover these needs, three powerful and open source platforms were selected, described in the next sections. To integrate these platforms or to meet further needs arising, additional software was produced in the form of modules extending the capabilities of these platforms.

2.6.1 Power Grid Simulation Platform

GridLAB-D is selected as the power system simulation platform. GridLAB-D is a power distribution system simulation technology developed by the US Department of Energy at Pacific Northwest National Laboratory in collaboration with industry and academia. Its most powerful characteristic is that it provides simulation of the full range of the power system including electricity production, delivery and consumption systems, combining power flow equations with financial mechanisms. This is achieved with integrated modeling of power systems, energy markets, building technologies and various other resources and assets as illustrated in figure 2.11 [52].

The most important capabilities GridLAB-D provides include:

- end-use models including appliances and equipment models, consumer models. These models provide consumer behavior including daily, weekly, and seasonal demand profiles, price response, and contract choice

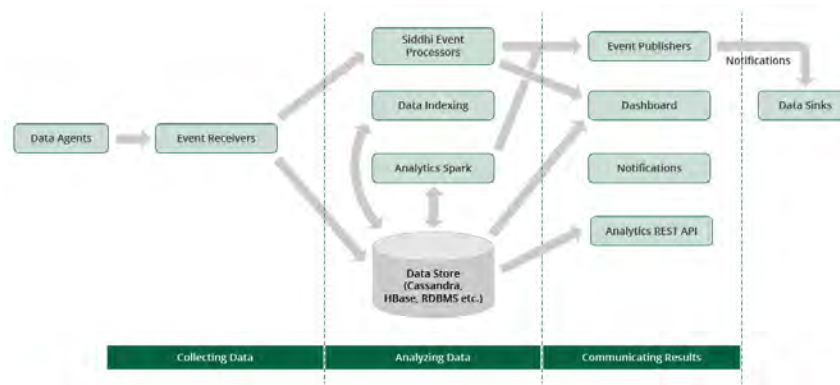

FIGURE 2.12: DAS Architecture. Source: <https://docs.wso2.com/display/DAS310/Architecture>

- distributed energy resource models. These models include appliance-based demand-response capabilities and distributed generator and storage models.
- retail market modeling tools, including retail rate, billing, and market-based incentive programs.
- climate models that provide an interface to other simulated objects in order to include weather data in their calculations. Climate models read climate data from TMY2 files, created and maintained by the National Renewable Energy Laboratory (NREL).
- ability to run both in real-time mode and in simulation time mode. Real-time mode allows us to create cyber-physical systems, integrating real devices with the simulated grid, while simulation time mode allows us to run simulations ranging from sub-second to many years.
- ability to run efficiently on multicore and multiprocessor machines

2.6.2 Data Analytics Platform

WSO2 Data Analytics Server(DAS) is selected as the data analytics platform to be used in the experiments run in this dissertation. DAS architecture is illustrated in figure 2.12.

The WSO2 DAS architecture consists of the following components:

Data Agents: external sources that publish data to DAS. Data Agents reside in external systems and push data as events to the DAS

Event Receivers: receive data published by Data Agents. Each event receiver is associated with an event stream, which is then processed by Event Processors.

Analytics REST API: Additionally to Event Receivers, DAS supports REST API based data publishing.

Data Store: used for data persistence. There are three main types of Data Stores, Event Store, Processed Event Store, and File store. Event Store is used to store events that are published directly to the DAS. Processed Event Store is used to store resulting data processed using Apache Spark analytics. File store is used for storing Apache Lucene indexes.

Event Processors: DAS uses a realtime event processing engine which is based on Siddhi a query language designed to process event streams and identify complex events.

Analytics Spark: used to perform batch analytics operations on the data stored in Event Stores using analytics scripts written in Spark SQL.

Data Indexing: a process running in a predefined frequency, that updates Lucene indexes for the indexed fields of an event stream.

Event Publishers: Output data either from Spark scripts or the Siddhi Complex Event Processor engine are published from DAS using event publishers. Event Publishers can be of various types such as SOAP events, HTTP events, Web-Socket Events, emails, SMS and other.

Analytics Dashboard: is used for descriptive data analytics. It consists of several dashboards each with a set of gadgets. Data either from a Data Store or from a realtime event stream, can be used as the source of data for each gadget.

Event Sinks: are the components external to DAS. Event Publishers send various event notifications to Event Sinks.

2.6.3 Blockchain Client

The Go implementation of the Ethereum client, know with the name *geth*, was employed in the experiments presented in part III.

Ethereum is a general purpose blockchain implementation, focusing mainly on facilitating the operation of decentralized applications. Decentralized applications are based on smart contracts. Contracts are typically written in a high level language, such as solidity³, and then compiled into Ethereum Virtual Machine byte code. The byte code is then deployed on the blockchain.

Geth provides the following interfaces:

- Command line interface.
- JSON-RPC API.
- JavaScript API for Dapps
- JavaScript console that exposes the full JavaScript Dapp API and the admin API.

Also, Ethereum provides the following consensus algorithms:

- Proof-of-Work
- Proof-of-Stake
- Proof-of-Authority

³<https://solidity.readthedocs.io/en/latest/>

Part II

Systems and Data Analysis

Chapter 3

Real-Time Data Analytics Platform for Power Grids

The main objective of this chapter is to elucidate issues that concern the integration of existing software systems and platforms into an open-source, open-architecture simulation engine that delivers large scale data analytics for the efficiency and stability of next generation power distribution grids. Our objective is achieved through the design and the implementation of a prototype simulation engine that couples state-of-the-art software from both the electrical engineering and information sciences. The effectiveness of our system is examined through two realistic large and detailed simulation scenarios which also involve machine learning and game theory.

3.1 Introduction

Smart-Grid is an intelligent network that utilizes two-way communication of flows of electricity and information to create an automated and distributed power management system. On a smart-grid, houses are equipped with smart meters that distribute the electricity from the power line to appliances. The two-way communication makes it possible for the smart meters to collect and report users demand and preference information into a central system. Such information can then be used to design more efficient load distribution strategies that minimize the overall energy consumption while ensuring the stability of the grid and users preferences. The design of such systems requires techniques and technologies to harvest, analyze and visualize power grid data that involve a number of disciplines, including statistics, data mining, machine learning, signal processing, pattern recognition, optimization and visualization.

In this chapter we present a novel reference architecture for a Smart Grid Descriptive and Predictive Analytics platform which integrates two widely used tools, an energy simulation platform and a data analytics server. We use GridLab-D that combines power flow equations with financial mechanisms and WSO2 [53] Data Analytics Server (WSO2 DAS [54]) which is a comprehensive enterprise data analytics platform that fuses batch and real-time analytics of any source of data with predictive analytics via machine learning.

Subsequently, this platform is used to implement a novel demand side management algorithm that has potential to provide increased 1) optimization and 2) equilibrium capabilities to next generation energy market systems. In particular, we consider auction based energy markets, where producers (i.e. energy sources) and consumers place their bids and we study the effectiveness of these markets. These algorithms have their roots on machine learning, game theory and other AI scientific

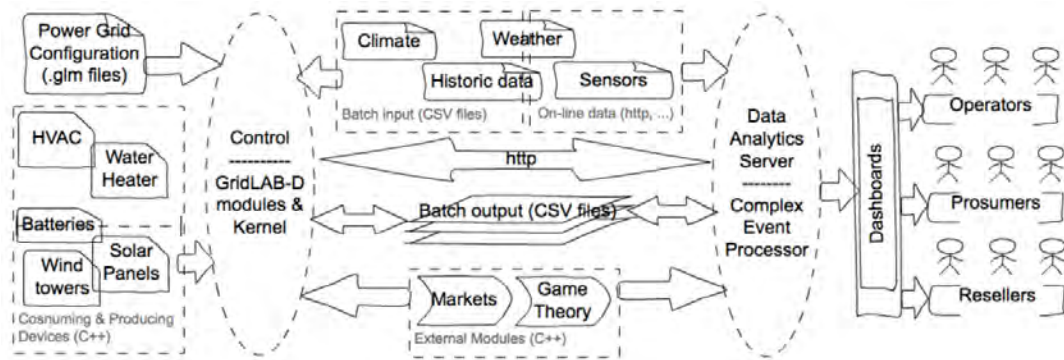

FIGURE 3.1: The functional view of the system architecture considered

areas and are in some cases supported by data science in general, Big Data Analytics and Deep Learning in particular.

The proposed platform will allow us to collect data generated by heterogeneous sources, analyze them and visualize selected results. Data sources include, but are not limited to, data generated by GridLAB-D's simulations [55], by real smart meters and devices, meteorological data and data provided by weather forecasting services, sensors of any type and historical data. Data are provided to DAS in data streams and are sent to the Complex Event Processor (WSO2 CEP [56]) of DAS at real time. Complex event processor collects them and provides a real time analytics pipeline. WSO2 CEP facilitates identification of meaningful events from the data sources, correlation of data and analysis of their impact.

WSO2 CEP is powered by WSO2 Siddhi, a lightweight, easy-to-use Open Source querying language. Siddhi is especially suited for complex queries involving time windows, as well as patterns and sequences detection. Siddhi is responsible for parts of the data communication shown in the center and the right part of figure 3.1.

An integral part of WSO2 Data Analytics Server is its dashboard. We use dashboards to visualize the data both in real time as they arrive from the data sources to DAS, but also we create views to compare the results between the various experiments we conduct and provide the descriptive analytics results to end users. These end users include but are not limited to, producers, consumers, resellers and grid operators.

In the platform described in this chapter, a multi-way communication between GridLAB-D and WSO2 server (i.e. DAS) has been enabled. This implementation provides data from the grid to WSO2 servers in order to analyze them, and subsequently give the consumers and producers connected to the grid, access to predictive analytics results. This allows us to design and study complex demand response and demand side management algorithms to stabilize the grid and let it run in an "optimal" manner.

The fact that GridLAB-D and DAS server are open source systems allows us to develop modules that expand their capabilities.

In figure 3.1 we present the functional view of the architecture of a soft/hard grid system we consider in this study. Starting from its left we assume that domain experts (mainly electrical engineers) provide the necessary information about the distribution grid (the IEEE bus characteristics for example) in a form required by GridLAB-D. They also provide new (or modify existing ones) C++ modules that encapsulate the business logic of the main consuming and producing devices. This business logic add the basic layer for the smartness of the power grid. It transforms

the dump otherwise devices into agents with basic reactive and collaboration capabilities.

GridLAB-D then runs the power flow model on the prescribed time interval and utilizes existing or new external modules and batch or real time on line data to solve the power flow (and parts of the optimal power flow) problem [55]. It then outputs the results either at real time (through for example http) or through batch files to the Complex Event Processor (CEP).

DAS/CEP get data from a plethora of sources and utilizes software modules and a variety of other tools to provide further intelligence to the power grid in the form of reactivity, proactivity and social ability. In several cases it collaborates closely with GridLAB-D modules and control mechanisms to achieve power and economic stability.

DAS/CEP exports selected results in textual form through http to GridLAB-D and to the dashboard, and in visual form or other graphics devices or batch data files to the various stakeholders.

In this study we consider the above system as a whole, we focus though on double auction based energy markets. We study the effectiveness of these markets and the impact of real-time machine learning and game theory on their implementation and the economic and power stability of the grid.

For a recent study that utilizes GridLAB-D for large scale experimentations without machine learning in a way similar to the one we follow in this chapter, the reader is referred to [57].

3.2 Basic Concepts, Objectives and Software Systems

As discussed in the previous section the contribution of this chapter is two-fold. First we present the details of the new data analytics platform which we designed and implemented by integrating WSO2 DAS and GridLAB-D. The use of WSO2 analytics platform enabled the real-time observation of the results. In particular DAS allows us to repeat experiments easily and bring much needed enterprise features like high availability, scale etc.

The above also gave us a deep understanding of the effect the demand side management algorithms have on each consumer and on the energy market as a whole. Also the integration of the two systems, GridLAB-D and WSO2 DAS, allows us to study the effectiveness of various prediction algorithms already implemented in WSO2 DAS.

Second we propose a novel load distribution algorithm by extending our previous work presented in [58]. In [58] we have used elements of game theory [59]–[61] to solve the optimization problem of energy consumption between the consumers and producers of the grid. The expansion is achieved mainly with the use of data analytics tools along with the power grid simulation engine.

Figure 3.2 illustrates the reference architecture for the Smart Grid Analytics use case and may be considered a component wise simplified view of the one given in figure 3.1.

We integrate the GridLab-D with WSO2 DAS which has a built-in complex event processing (CEP) engine powered by WSO2 Siddhi. WSO2 DAS is a comprehensive enterprise data analytics platform. DAS includes Apache Spark for batch analytics, Siddhi for real time analytics and Apache Sparks' MLib for predictive analytics. DAS effectively helps us to gather insightful information regarding the energy markets,

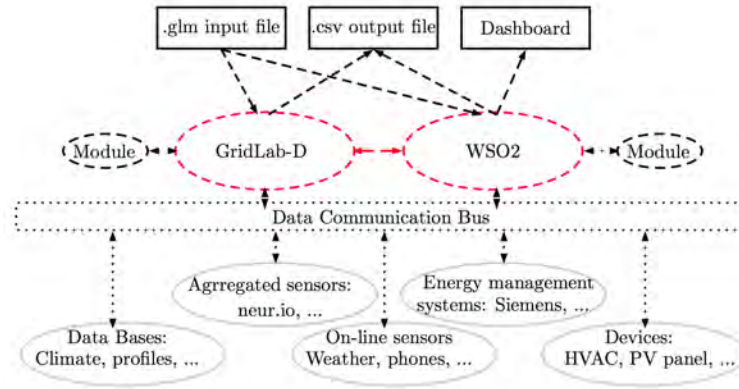

FIGURE 3.2: The component view of the system architecture used in our study

TABLE 3.1: Prediction models

	RMSE	MAPE	Accuracy
Clearing Price	0.0269	7.71%	92.29%
Supply	470.0	6.63%	93.37%

make well-informed decisions based on energy demand and allows us to monitor this insight via user-friendly dashboards for descriptive purposes.

3.3 Modules for Decision and Equilibrium

3.3.1 Prediction Modules

We implement modules which provide prediction capabilities to grid users. We use different machine learning algorithms to predict the market clearing price. This prediction of the price is based on historical weather data and data collected from the grid including market data, consumers' and producers' data. The model trained using Random Forest Regression algorithm yielded the highest accuracy for clearing price.

For experiments related to the Non-Cooperative game, an energy supply prediction model was implemented. This prediction was also based on historical weather data and market data. In order to bring up the auto correlation between successive supply predictions, all training data was preprocessed, i.e feature engineered using a sliding window. This feature engineering introduced additional features such as mean, median and standard deviation of the existing data to the training process. Although several algorithms were used for the training process, the model trained using Random Forest Regression yielded the highest accuracy.

These prediction modules will be used by consumers to maximize their economic benefits from their participation in the market. The machine learning algorithms that were evaluated for the prediction modules are Relevance Vector Machine regression algorithm, Linear Regression algorithm and Random Forest Regression. Their effectiveness was measured and compared and the results are presented.

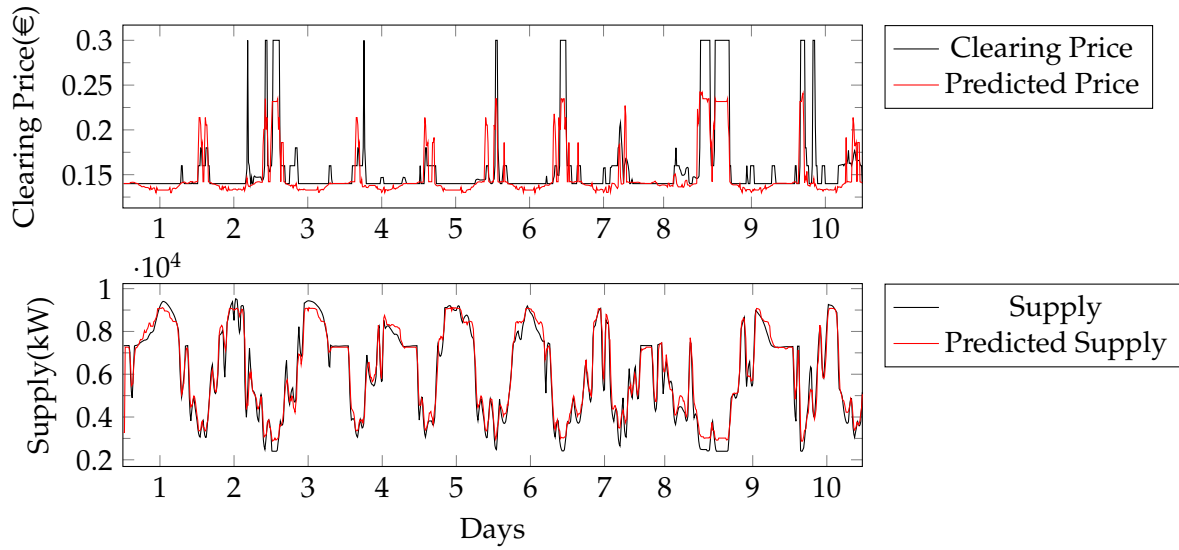

FIGURE 3.3: Clearing price prediction(top), Supply Prediction(bottom)

The results obtained from both the prediction models can be summarized as shown in Table 3.1. The best performing clearing price prediction had a Root Mean Squared Error(RMSE) of 0.0269 and Mean Absolute Percentage Error(MAPE) of 7.71%. The feature engineered supply prediction model had a RMSE of 470.0 and MAPE of 6.63%.

3.3.2 Game Theory Modules

We implement modules that give consumers the ability to interact with each other and make decisions either in a cooperative or in a non-cooperative manner. Supply prediction capabilities will be used by game theory modules and will allow consumers to take decisions in a direction that will contribute to grid's stability, matching supply with demand. Consumers use their available demand elasticity to come to an equilibrium. This equilibrium will result in economic benefits for the consumers and increased market stability in terms of measures such as peak-to-average.

The experiments are conducted on varying market clearing periods and we try to elucidate which consumers' characteristics define the extent to which a consumer can benefit from the participation to these markets. More specifically, we run our experiments with market clearing period set to 1 minute, 15 minutes and 1 hour.

The validation of these algorithms and the measurement of their effectiveness is quite challenging due to the large number of factors that should be taken into account. We must take into account the stability of the grid, the stability of the market, user's wishes and comfortableness. This can be done by studying the data produced by the grid, data of great volume, variety and velocity.

Following the definition in [62], a non cooperative game is defined by a triple $G = \{N, (S_i)_{i \in N}, (U_i(l))_{i \in N}\}$, where N is the set of active consumers participating in the game, S_i is the set of possible actions consumer i can take and $U_i(l)$ is the payoff function. Following [63] we define the payoff function as:

$$U_i(l^t) = -LR_i(l_i^t) - p(l^t)l_i^t, \text{ where } 0 \leq l_i^t \leq l_i^{t,max} \quad (3.1)$$



FIGURE 3.4: WSO2 DAS Dashboard

where l_i^t is the energy consumption of consumer i in time slot t based on the non-cooperative game results, $l_i^t \in S_i$. $l_i^{t,max}$ is the amount of load consumer's i HVAC system needs to consume based on the current air temperature of the house, the outdoor temperature, the thermal characteristics of the house and the temperature the consumer has set as target for the house air temperature and l^t is the total load consumption by all consumers at time slot t . $LR_i(l_i^t)$ is the load reduction function and it denotes the cost of reducing the energy consumption from $l_i^{t,max}$ to l_i^t . $p(l^t)$ is the electricity price at time slot t when the total load consumption by all consumers at time slot t is l^t .

In our system set up, the consumers that participate in the game are those that send and receive data to and from DAS server. Those consumers calculate their demand for the next market period and they send this calculated amount to DAS server. DAS using supply prediction algorithm and by matching the predicted supply with the demand at the Nash Equilibrium obtains the demand elasticity value of the parameter λ at the Nash Equilibrium. This λ value is send back to the consumers, who change their cooling and heating set points in order to change their load consumption according to the game result.

A more detailed description of the game formulation will be given in section 6.

3.4 Prototype Implementation and Indicative Experimentation

An HTTP client socket connection was created between GridLAB-D and WSO2 DAS to facilitate the communication among them. Related data is sent as a POST request, embedded in XML format from GridLAB-D to WSO2 DAS through a socket created on the tape module of GridLAB-D. Upon receipt of this request, WSO2 DAS extracts the data from the XML message and sends them to their respective streams. Then, these streams go through complex Siddhi queries to perform the calculations, and play a Non-Cooperative game for each simulation minute.

These queries include the calculation of the demand elasticity which is the ultimate result of the non-cooperative game played. Once demand elasticity is calculated, it is sent back to GridLAB-D using a HTTP POST output. A client socket connection created on server thread of GridLAB-D fetches the request, extracts the value and sends it to the controller thread. Then the controller utilizes the value,

TABLE 3.2: Power sources and their characteristics

Type	Cost (€/KWh)	Capacity
Large Wind Turbine	.16	2.5
Large Wind Turbine	.14	2.5
Smaller Wind Turbine	.18	1.5
50 Solar Panels (30m ² each)	.12	2.5
The power Grid	.30	-

TABLE 3.3: Clearing Prices (in €/KWh)

	Max	Min	Average
Default	0.3	0.021	0.152
PP	0.3	0.018	0.145
GT	0.232	0.027	0.135

TABLE 3.4: Cost Variation

	Max	Min	Average
PP	+16.36%	-2.25%	+2.82%
GT	0%	-15.08%	-10.88%

i.e demand elasticity, and does the necessary changes in the temperature setpoints before submitting the final bid.

Apart from sending data to GridLAB-D, DAS also publishes certain selected data on WSO2 DS (Dashboard Server). WSO2 DS is capable of creating charts and visualizing these data in real-time. Figure 3.4 shows a screen shot of the DS taken during an experiment.

Our experiments use the IEEE-13 bus test feeder, a short and relatively highly loaded feeder that contains a substation voltage regulator, overhead and underground lines, with variety of phasing, shunt capacitor banks, in-line transformer, unbalanced spot. We have distributed the houses and the local renewable energy sources on most of the nodes and we connect our feeder to the power grid through a central node. The power sources connected to the feeder and their characteristics can be found in Table 3.2.

This chapter mainly focuses on the following two types of experiments, the price prediction (PP) and the game theoretic (GT) experiments. These experiments are very representative for future energy market operations. Their results are presented and compared with each other and with the default consumers' behavior simulated by GridLAB-D.

In Figure 3.5 we can see how the air temperature of a house changes during the 10 days of the simulation time, when this house uses the price prediction algorithm (orange color), when this house participates in the game (red color) and these results are compared with the default behavior of the house (black color). The HVAC system of the house has its thermostat's cooling set point set to 22°C and its heating set point set to 19°C

In Figure 3.6 and Table 3.3 we can see the results concerning the clearing prices in the three experiments. Price prediction algorithm decreases both the minimum clearing price and the average clearing price while it keeps the maximum clearing price unchanged. Game theory algorithm decreases maximum and average clearing

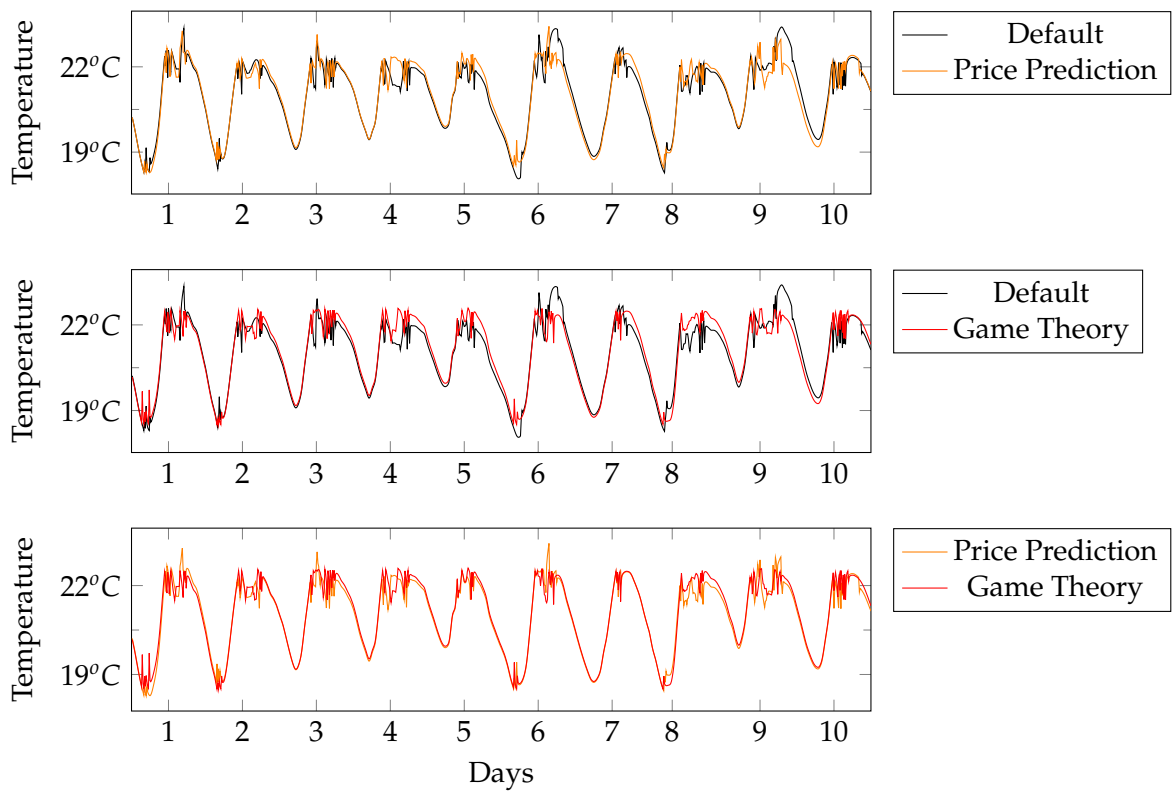

FIGURE 3.5: House Air Temperature

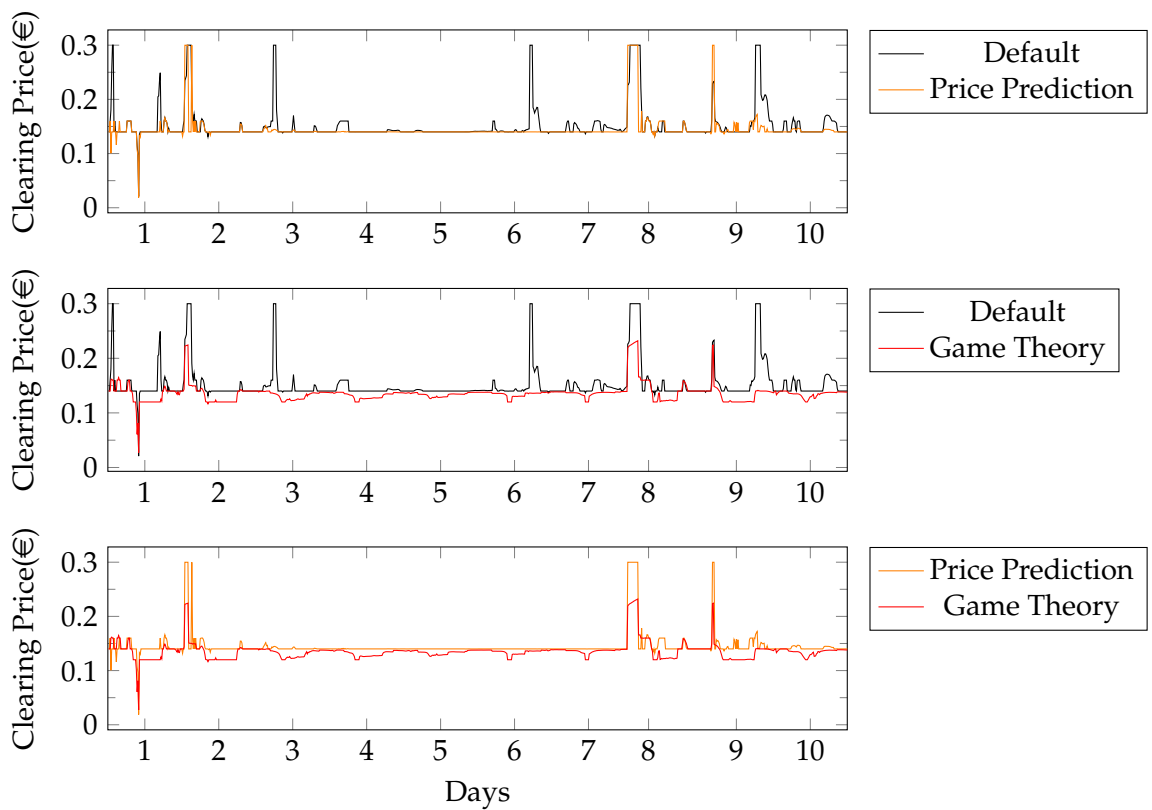

FIGURE 3.6: Market Clearing Prices

TABLE 3.5: Total Demand and its Characteristics

	Peak Demand	Average Demand	Peak-to-Average
Default	2941.03	1942.304	1.51
PP	4001.33	1726.221	2.31
GT	2879.95	2093.626	1.37

prices while it increases the minimum clearing price. $0.3\text{€}/\text{KWh}$ is the price for the energy withdrawn from the main grid (Table 3.2). A clearing price of $0.3\text{€}/\text{KWh}$ means that the amount of energy available from the renewable energy sources at that time slot was not sufficient to cover the demand, a large proportion of which was met by energy from the main grid. The fact that game theory results give a maximum clearing price lower than $0.3\text{€}/\text{KWh}$ means that the game theory module, enables the consumers to cover their needs using the available energy from the renewable energy sources in a very effective way.

Figure 3.6a compares the results of the price prediction experiment with the default behavior. We can see that the use of the price prediction algorithm results in a decreased number of time slots with a clearing price of $0.3\text{€}/\text{KWh}$ but there still exist time slot with this clearing price. In Figure 3.6c, comparing the price prediction results with the game theory, we can see that the red line no longer reaches the clearing price of $0.3\text{€}/\text{KWh}$.

These clearing prices define the amount of money the consumer is going to pay for the energy consumed. In Table 3.4 we can see how the cost for the consumers changes for the two experiments, PP and GT, compared with the default behavior. The results for the price prediction algorithm are ambiguous, as far as the cost for the consumers is concerned. The use of the price prediction algorithm by the consumers can result in a decrease in their cost up to 2.25%, while some consumers may experience a significant increase up to 16.36%. The effect that the game theory algorithm has to the consumers' cost is clear, the game theory algorithm results in a decreased cost for all the consumers, with a maximum decrease of 15.08% and an average decrease of 10.88%.

Figure 3.7 and Table 3.5 present the effect that the two algorithms have in market's total demand. In Figure 3.7a we compare consumers' total demand, as it takes shape with the default consumers' behavior and when they all have access to the price prediction algorithm. It is clear that when all consumers have access to the price prediction algorithm they behave uniformly, and this behavior leads to many time slots with zero demand and a very high peak demand. Table 3.5 also verifies this observation, the use of the price prediction algorithm has decreased the average demand but has also led to a considerably increased peak demand. Figure 3.7b shows how total demand changes when consumers participate in the game. Consumers' participation in the game results in increased demand in certain time slots and in a decreased peak demand. This happens because the non-cooperative game tries to match demand with supply and consumers do not take decisions based on price. The increased average demand is a result of the ability the game gives to consumers to be able to take advantage of the available energy from the renewable energy sources. In Table 3.5 we can see that game theory results in a decreased peak demand and in an increased average demand but the Peak-to-Average(PAR) ratio, a

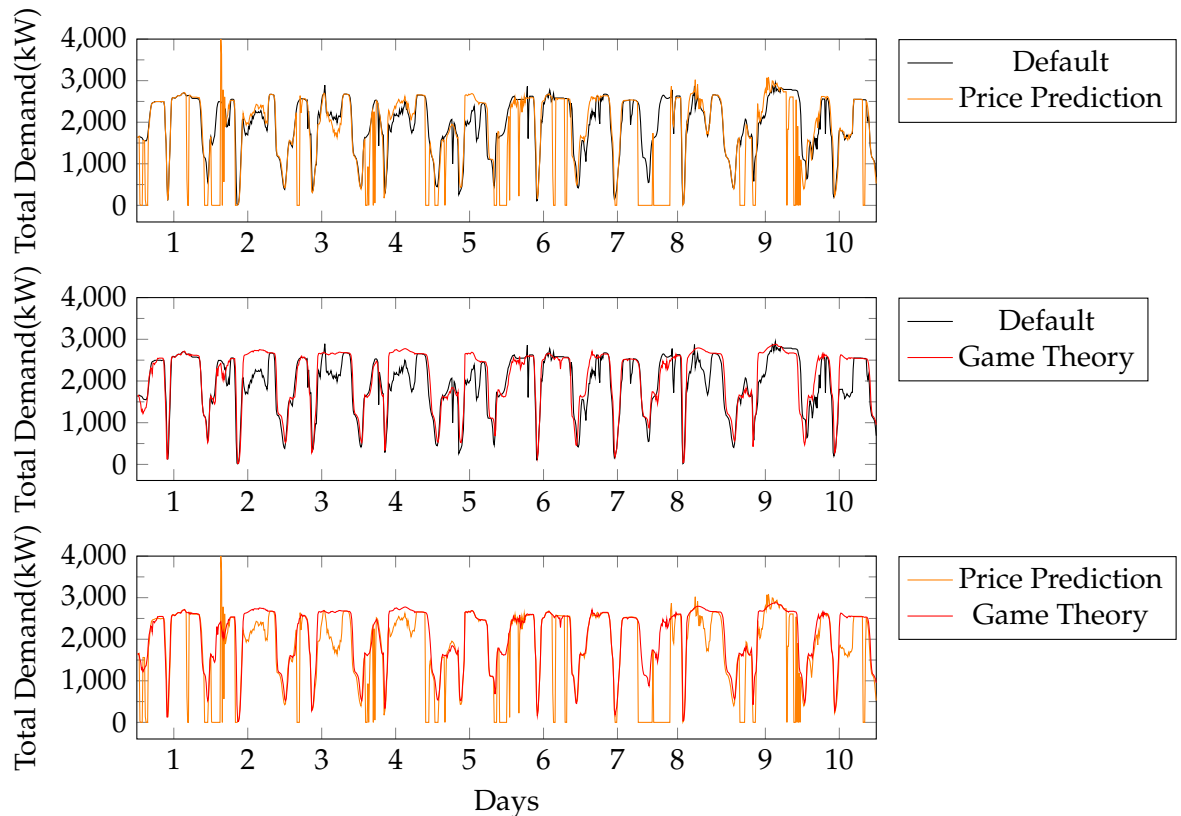

FIGURE 3.7: Total Demand

critical characteristic that affects grid's steady state operation is improved.

3.5 Synopsis and Prospects

Next generation power grids that are intelligent and smart promise a lot but do not currently exist. This chapter presents initial efforts of an on-going project towards the design, prototype implementation and analysis of a system that couples various software components diverse in their nature, origin and main characteristics to offer a simulation engine that allow us to elucidate several issues.

We will further study the characteristics of our prototype system. In particular we will investigate the possibility of transforming our simulation engine into a Cyber-Physical system which in turn could be naturally evolved into a real time operational power distribution system or even system of systems.

The application of prediction models and the game theoretic interaction of energy market participants will be studied in detail in chapters 5 and 6 respectively.

Chapter 4

Visualizing Power Distribution Systems

4.1 Introduction

Smart grid relies on technologies that collect and organize large amounts of data concerning power production, distribution and pricing. These data need to be effectively retrieved, analyzed and delivered at almost real time to all stakeholders; from powerful operators to huge producers, to household consumers and soon to devices themselves. Compared to the legacy electric grid operation system, the smart grid provides new functionalities, such as support for decentralized power generation and storage capabilities, accommodation of plug-in electric vehicle charging stations, integration of vehicle-to-grid peak saving strategies and implementation of demand response decisions. The smart grid allows for customer participation in grid operation so that consumers will not only produce data but respond to data as decision makers within the context of demand response frameworks.

Information associated with power systems traditionally is presented to the operator as numeric data on single line diagrams or by tabular list displays. Due to high growth rate and integration of market forces, traditional visualization techniques need to be reviewed and enhanced.

It is extremely vital to present the vast amount of data to the various operators in a way so as to facilitate quick assimilation and assessment of the situation. Effective visualization of the system improves the operators' ability to monitor and correct the anomalous conditions in a grid.

Furthermore, it is also of extreme importance to present these data to the consumers as well, in order for them to gain an active role in interacting with the system and to be aware of changing conditions to their energy use and behavior. Other stakeholders (e.g resellers, power production operators) benefit from the analysis of these data significantly as well.

In this chapter we study the application of Self-Organizing Map (SOM) data analysis method on power grid data. More specifically, we extend an existing visualization layer on top of GridLAB-D. The visualization layer is part of the thesis **Visualizing New Generation Energy Systems** submitted by **Lamprini Vasilaki** in University of Thessaly, while the present work extends this layer by adding the SOM module.

The rest of this chapter is organized as follows. In the next section we present the basic recent studies that apply SOMs in power grids. Section 4.3 presents the design and prototype implementation of a comprehensive web-based visualization layer for GridLAB-D. Our concluding remarks can be found in Section 4.4.

4.2 Related Work

Self-Organizing Map (SOM) is a data analysis method that combines visualization and machine learning to analyze data. It classifies large dimensional data by projecting them onto low dimensional images in an orderly fashion and visualizes similarity relations of the input data. Although there is not yet a strong proof of the convergence of the SOM algorithm for initial data of general dimensionality and distribution it seems in practice to converge under a reasonable choice of parameters [64]. SOMs have been applied to problems from many disciplines. The rest of this section is devoted to the recent application of SOMs in power grids.

In [65] SOMs are used to identify malicious attacks on the smart grid. Such attacks could target, for example, in altering the consumers' bills or cause a disruption in grid's operation. The goal in this study is the clustering of data collected during grid operation into two classes, normal and anomalous. This is achieved in three steps. Firstly, data of a typical household are collected for the whole 24-hour period. Secondly those data are complemented with data of anomalous device behavior, and this results to a labeled data set. Finally this dataset is used to train a SOM in a way that it enables it to classify smart grid's data as normal or anomalous and detect any intrusive activity through out the grid.

[66] presents an effort on identifying how dynamic pricing and demand response affects households. Here SOMs are employed to find the correlation of several building characteristics with the impact that dynamic pricing has on these households. For example, SOMs confirm that there is a correlation between the relative difference in annual cost, before and after dynamic pricing is applied, with the annual consumption in electricity. Experimental results presented lead to the conclusion that there is also a clear correlation between relative difference in annual cost with the surface area and the number of residents.

[67] describes an approach on customer base load estimation using both SOM and K-means clustering. More specifically, the proposed procedure consists of three steps: (1) Data preprocessing (selection, cleansing, reduction), (2) SOM and (3) K-Means clustering. Preprocessing phase is essential because during storage of data retrieved by the grid some information may be missing or be distorted. During the data preprocessing step historical data are read from a database, the more significant out of them are selected, the outliers are cleansed and the more suitable, in terms of weak-day or weather are pushed forward to the next step. SOM is then used to transform high dimensional data provided by preprocessing step, into two dimensional vectors. Subsequently, those vectors are clustered using K-means clustering. This procedure results in a base load estimation which is used for measurement and verification of demand response mechanism.

In [68] a SOM is utilized for the implementation of a neural network model. This model is used to perform predictive voltage stability assessments on the grid and predict emergency conditions. It receives measurements from the power grid and state variables computed by the devices of the grid. Consequently this information is provided to the SOM and it is classified based on security. Based on the input SOM classifies the power grid's state as one of the following: (a) Emergency - Non-correctable, (b) Emergency - Correctable (c) Alert and (d) Normal.

The main goal of [69] is the recognition and modeling of controllable electrical heating loads of residential users. Taking advantage of the available data from smart meters and meteorological stations, authors propose their approach combining clustering and predictive regression modeling. Consumers' clustering as electrically heated or not is performed using SOM and k-means algorithms, while prediction

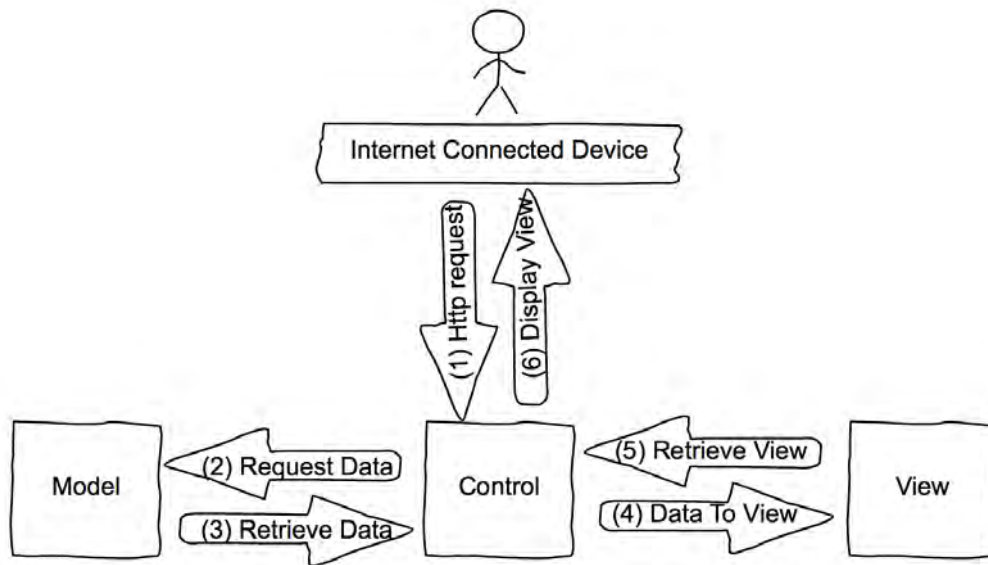

FIGURE 4.1: Schematic illustration of MVC Architecture

of hourly average power consumption is given using a Support Vector Regression model.

4.3 Design and implementation

Our web application, is based on the widely adopted MVC (Model – View – Controller)¹ architecture for building dynamic web sites with clean separation of concerns. MVC consists of three layers with fully independent capabilities. The Model Layer is responsible for storing and loading data to and from the application's database, the View Layer for displaying on demand data for the user and the Controller Layer is the layer between the Model and View layer. More specifically, the Controller receives the requests for the application and in cooperation with the Model layer prepares the data which may be utilized by the View layer. In turn, the View layer utilizes the data that are available from the Controller layer in order to generate the response.

In figure 4.1 the numbered steps show the flow of information between the application and the MVC's layers.

4.3.1 Technologies

In general, front-end and back-end technologies are utilized for the development of the proposed web application. Front-end technologies provide the user interface of the application while back-end technologies provide the desired features of the web application. The next subsections present the technologies selected for the prototype implementation.

¹<https://en.wikipedia.org/wiki/Model-view-controller>

Back-end Technologies

The cross-platform runtime environment *Node.js*², is utilized. Specifically, we rely on *Express.js* a standard server framework for Node.js, designed to build from single and multi page applications to hybrid. *Node.js* applications could be built by using the *Sails.js* a recently developed web framework. Thus, users use a browser to communicate with the Node.js Server in order to have access to the application. HTTP protocol is used for the data transfer between the client and the server.

MySQL Relational Database Management System has been selected. It is a widely used database, simple and suitable for the most database models.

For the implementation of the SOM component we have used an open-source implementation of a self-organizing map in JavaScript for node.js from Lucid Technics, LLC³.

Front-end Technologies

HTML (Hyper Text Markup Language), the most common front-end language is used. It is coupled with *CSS* (Cascading Style Sheets) for formatting and offering style to the web pages and *JavaScript* a widely used high level, dynamic and script language. The JavaScript library, *jQuery* that combines versatility and extensibility is also used.

Due to the fact that our application commonly involves asynchronous calls *Ajax*, a set of technologies used on the client side in order to create asynchronous applications is needed. Furthermore, *JSON* (JavaScript Object Notation) another widely spread derived language from the Javascript has been used.

A most recently developed backend technology is the *AngularJS*⁴, an open source web application framework which works as follows: in the beginning it scans the HTML page by reading the tag attributes and it interprets those attributes to tie down parts of the page to a model.

Data visualization tools

In order to visualize the results of a power flow simulation in an effective way various visualization tools are used. Starting with SVG an XML-based vector image format for two-dimensional graphics and HTML5 Canvas, a component of HTML5 that permits dynamic, scriptable production of 2D images and shapes.

Additional Javascript libraries, like the *Highcharts*, the *Charts.js* and the *Heatmap.js* are utilized. The actual use of those libraries will be depicted in the next subsection where the web application is presented in some details.

4.3.2 Prototype Implementation

The GridLAB-D and the web application are both connected to the same database. During the simulation selected data are stored in real time to the database. The selected data describe the status of the basic elements of the distribution grid. One table in the database is created for each one of these elements, these tables are:

- **Nodes:** Contains information about each node such as the nodeID, the phase, the voltage per phase, and the current per phase.

²<https://en.wikipedia.org/wiki/Node.js>

³<https://github.com/LucidTechnics/som>

⁴<http://www.w3schools.com/angular/>

- **Houses:** Contains information about each house such a unique id, the phase, the total load consumed and the reactive power.
- **Central_triplex_meters:** Contains information concerning the triplex meter which connects the house to the grid and plays a crucial role in the distribution feeder. The columns of the table are associated with the nodeID in which the triplex_meter is connected to, the real power and the reactive power at each time instance.
- **Devices:** Contains information about the devices belonging to a house. Each device has a unique device id, related to the house that it belongs. The phase, the type of the device, as well as the bid price and the bid quantity of each device and the total load consumed from the device are also depicted.
- **Energy_sources:** Contains details about the distributed energy sources of the grid. This includes the node to which the energy source belongs, the type of energy source (e.g. Diesel, Wind or Solar), real, reactive power and the bidding price and quantity.
- **Market_pools:** Contains information related to the market such as the clearing price, clearing quantity, buyer's total quantity and seller's total quantity.
- **Transformers:** Contains information about the distribution transformers of the system. Only the power (real and imaginary) per phase are stored in that table.

In figure 4.2 the homepage of the proposed web application is illustrated. The user selects the object from which the simulation data will be visualized. For a detailed presentation of the full application the reader is referred to [2].

To use the SOM component the user has to select the features each input vector should contain. Those features are selected using the form in SOM initialization page (figure 4.3). The user selects the simulation date of the data that will be classified using SOM, the object type, and the specific attributes, combined with some available mysql functions, such as MIN, MAX and AVG. In the specific example presented in figures 4.3 and 4.4 user has selected to classify houses consumption behavior. The dimension of the input vector will be 6 as the user has selected 6 of the available attributes for each house: minimum reactive power, maximum reactive power, average reactive power, min total load, max total load and average total load during the time interval selected (see: figure 4.3). The number of the input vectors will be the number of houses simulated for the date selected. In the final two inputs of the input form, the user selects the dimensions of the unified distance matrix (U-Matrix) that will be generated by the SOM component. In figure 4.4 we view the result of the initialization described above. The result is a U-Matrix where each cell represents a map unit of the output space of SOM. Each unit is represented by a weight vector that effectively represents the input vectors assigned to that unit. The color of each unit represents the Euclidean distance from its neighbors. Light blue color is assigned to units with long distance with their neighbors, while dark blue color is assigned to short distances. With mouse over on each cell we can see the information each cell carries, which is the number of the input vector assigned to that unit, the value for each attribute selected and the distance between the unit and its neighboring units.

With a quick look at the generated U-Matrix we can observe that at the top left and bottom right units we have consumption patterns that are quite similar because of the color assigned to that units, while at the region in between we have quite diverse

List Of Tables

Here is a list of all the tables containing in our Web Application. To start the navigation you can select the table you are interested in by clicking on it. You can also view the tables from the navigation bar on the top of the page, by clicking on "Select Table" selection and choosing the table that you desire.



Central Triplex Meter

This table contains information about the unique Central Triplex Meter of the System. To be more specific contains the values for Real & Reactive Power for each central node of the system per day.

[Go to graph](#)

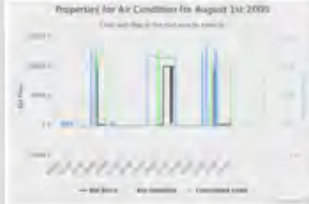

Devices

This table contains information about all Devices belonging to a house. Each device has a Bid Price and a Bid Quantity that beats in the auction and the Consumed Load that actually consumes.

[Go to graph](#)

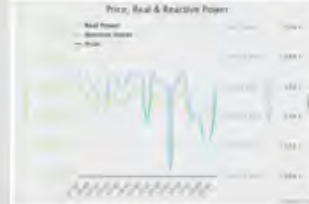

Energy Sources

This table contains information about Energy Sources of the System, which are divided in three categories. It contains information about Real & Reactive Power per node, as well as the Price that the Energy is selling.

[Go to graph](#)



Houses

In this table you can view the total load each house of the System consumed per day and how much of this load turns into Reactive Power. You can select one or more houses from the resulting list.

[Go to graph](#)

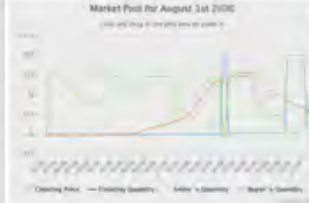

Market Pool

This table contains information about the Market Pool of the System. Specifically, it contains information about how the values of price and load change over time and per each day.

[Go to graph](#)



Nodes

In this table you can view how the Voltage belonging to each node and the Current is flowing among the Nodes of the System, as well as the System's behavior for each time quarter of a specific day.

[Go to graph](#)



Transformer

In this table you can view the value of the Power that flows into the transformer, the power that flows out of it and the power losses it probably has. This information is different for each phase of the system.

[Go to graph](#)

Device ID	House	Bid Price	Bid Quantity	Consumed Load	Real Power	Reactive Power
1	A	1.000000	1.000000	1.000000	1.000000	0.000000
2	A	1.000000	1.000000	1.000000	1.000000	0.000000
3	A	1.000000	1.000000	1.000000	1.000000	0.000000
4	A	1.000000	1.000000	1.000000	1.000000	0.000000
5	A	1.000000	1.000000	1.000000	1.000000	0.000000
6	A	1.000000	1.000000	1.000000	1.000000	0.000000
7	A	1.000000	1.000000	1.000000	1.000000	0.000000
8	A	1.000000	1.000000	1.000000	1.000000	0.000000
9	A	1.000000	1.000000	1.000000	1.000000	0.000000
10	A	1.000000	1.000000	1.000000	1.000000	0.000000
11	A	1.000000	1.000000	1.000000	1.000000	0.000000
12	A	1.000000	1.000000	1.000000	1.000000	0.000000
13	A	1.000000	1.000000	1.000000	1.000000	0.000000
14	A	1.000000	1.000000	1.000000	1.000000	0.000000
15	A	1.000000	1.000000	1.000000	1.000000	0.000000
16	A	1.000000	1.000000	1.000000	1.000000	0.000000
17	A	1.000000	1.000000	1.000000	1.000000	0.000000
18	A	1.000000	1.000000	1.000000	1.000000	0.000000
19	A	1.000000	1.000000	1.000000	1.000000	0.000000
20	A	1.000000	1.000000	1.000000	1.000000	0.000000
21	A	1.000000	1.000000	1.000000	1.000000	0.000000
22	A	1.000000	1.000000	1.000000	1.000000	0.000000
23	A	1.000000	1.000000	1.000000	1.000000	0.000000
24	A	1.000000	1.000000	1.000000	1.000000	0.000000
25	A	1.000000	1.000000	1.000000	1.000000	0.000000
26	A	1.000000	1.000000	1.000000	1.000000	0.000000
27	A	1.000000	1.000000	1.000000	1.000000	0.000000
28	A	1.000000	1.000000	1.000000	1.000000	0.000000
29	A	1.000000	1.000000	1.000000	1.000000	0.000000
30	A	1.000000	1.000000	1.000000	1.000000	0.000000
31	A	1.000000	1.000000	1.000000	1.000000	0.000000
32	A	1.000000	1.000000	1.000000	1.000000	0.000000
33	A	1.000000	1.000000	1.000000	1.000000	0.000000
34	A	1.000000	1.000000	1.000000	1.000000	0.000000
35	A	1.000000	1.000000	1.000000	1.000000	0.000000
36	A	1.000000	1.000000	1.000000	1.000000	0.000000
37	A	1.000000	1.000000	1.000000	1.000000	0.000000
38	A	1.000000	1.000000	1.000000	1.000000	0.000000
39	A	1.000000	1.000000	1.000000	1.000000	0.000000
40	A	1.000000	1.000000	1.000000	1.000000	0.000000
41	A	1.000000	1.000000	1.000000	1.000000	0.000000
42	A	1.000000	1.000000	1.000000	1.000000	0.000000
43	A	1.000000	1.000000	1.000000	1.000000	0.000000
44	A	1.000000	1.000000	1.000000	1.000000	0.000000
45	A	1.000000	1.000000	1.000000	1.000000	0.000000
46	A	1.000000	1.000000	1.000000	1.000000	0.000000
47	A	1.000000	1.000000	1.000000	1.000000	0.000000
48	A	1.000000	1.000000	1.000000	1.000000	0.000000
49	A	1.000000	1.000000	1.000000	1.000000	0.000000
50	A	1.000000	1.000000	1.000000	1.000000	0.000000
51	A	1.000000	1.000000	1.000000	1.000000	0.000000
52	A	1.000000	1.000000	1.000000	1.000000	0.000000
53	A	1.000000	1.000000	1.000000	1.000000	0.000000
54	A	1.000000	1.000000	1.000000	1.000000	0.000000
55	A	1.000000	1.000000	1.000000	1.000000	0.000000
56	A	1.000000	1.000000	1.000000	1.000000	0.000000
57	A	1.000000	1.000000	1.000000	1.000000	0.000000
58	A	1.000000	1.000000	1.000000	1.000000	0.000000
59	A	1.000000	1.000000	1.000000	1.000000	0.000000
60	A	1.000000	1.000000	1.000000	1.000000	0.000000
61	A	1.000000	1.000000	1.000000	1.000000	0.000000
62	A	1.000000	1.000000	1.000000	1.000000	0.000000
63	A	1.000000	1.000000	1.000000	1.000000	0.000000
64	A	1.000000	1.000000	1.000000	1.000000	0.000000
65	A	1.000000	1.000000	1.000000	1.000000	0.000000
66	A	1.000000	1.000000	1.000000	1.000000	0.000000
67	A	1.000000	1.000000	1.000000	1.000000	0.000000
68	A	1.000000	1.000000	1.000000	1.000000	0.000000
69	A	1.000000	1.000000	1.000000	1.000000	0.000000
70	A	1.000000	1.000000	1.000000	1.000000	0.000000
71	A	1.000000	1.000000	1.000000	1.000000	0.000000
72	A	1.000000	1.000000	1.000000	1.000000	0.000000
73	A	1.000000	1.000000	1.000000	1.000000	0.000000
74	A	1.000000	1.000000	1.000000	1.000000	0.000000
75	A	1.000000	1.000000	1.000000	1.000000	0.000000
76	A	1.000000	1.000000	1.000000	1.000000	0.000000
77	A	1.000000	1.000000	1.000000	1.000000	0.000000
78	A	1.000000	1.000000	1.000000	1.000000	0.000000
79	A	1.000000	1.000000	1.000000	1.000000	0.000000
80	A	1.000000	1.000000	1.000000	1.000000	0.000000
81	A	1.000000	1.000000	1.000000	1.000000	0.000000
82	A	1.000000	1.000000	1.000000	1.000000	0.000000
83	A	1.000000	1.000000	1.000000	1.000000	0.000000
84	A	1.000000	1.000000	1.000000	1.000000	0.000000
85	A	1.000000	1.000000	1.000000	1.000000	0.000000
86	A	1.000000	1.000000	1.000000	1.000000	0.000000
87	A	1.000000	1.000000	1.000000	1.000000	0.000000
88	A	1.000000	1.000000	1.000000	1.000000	0.000000
89	A	1.000000	1.000000	1.000000	1.000000	0.000000
90	A	1.000000	1.000000	1.000000	1.000000	0.000000
91	A	1.000000	1.000000	1.000000	1.000000	0.000000
92	A	1.000000	1.000000	1.000000	1.000000	0.000000
93	A	1.000000	1.000000	1.000000	1.000000	0.000000
94	A	1.000000	1.000000	1.000000	1.000000	0.000000
95	A	1.000000	1.000000	1.000000	1.000000	0.000000
96	A	1.000000	1.000000	1.000000	1.000000	0.000000
97	A	1.000000	1.000000	1.000000	1.000000	0.000000
98	A	1.000000	1.000000	1.000000	1.000000	0.000000
99	A	1.000000	1.000000	1.000000	1.000000	0.000000
100	A	1.000000	1.000000	1.000000	1.000000	0.000000

Devices Total Table

This is a table that contains information about Devices in table format. It includes exactly the same information with the "Devices" table, but in different form. We used the heatmap format for each factor of this table.

[Go to graph](#)

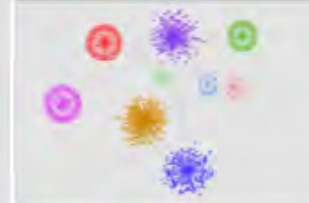

System Graph

In this table you can view the graphic topology of our whole System. It is a global diagram and it shows the connection among the nodes of the system, as well as all the houses containing by each node.

[Go to graph](#)

FIGURE 4.2: The homepage

GridLabDvisor Home Used Technologies About Developer Select Table -

SOM Initialization

This tool will help you visualize certain aspects of the power grid utilizing self-organizing maps.

Fill in the following inputs with the Date, the table and the certain features of each table that you want to use as features of the self-organising map. By choosing the table, attributes list will be updated and the available features for the selected table will be listed. Choose the values that you desire and the U-Matrix of the Self-Organised Map will appear.

Date: 01-08-2000

Table: Houses

Attributes: Min Reactive Power, Max Reactive Power, Avg Reactive Power, Min Total Load, Max Total Load, Avg Total Load

U-Matrix Width: 4

U-Matrix Height: 4

Search

FIGURE 4.3: Self-Organizing Map Initialization Page

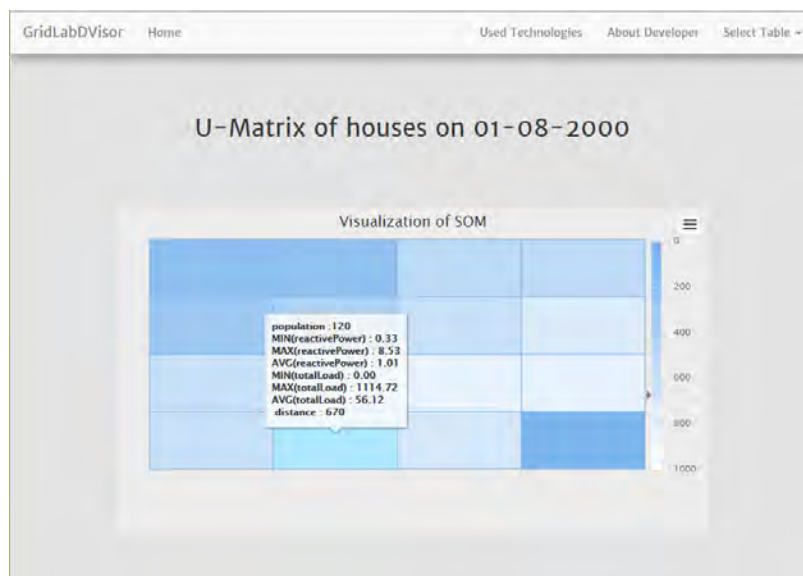

FIGURE 4.4: Self-Organizing Map resulting U-Matrix with Neuron features values shown

patters, patters with long euclidean distance between them. With mouse over on the cell we can see how many houses are represented by each pattern.

4.4 Summary

This chapter presents a review of the works utilizing Self-Organizing Maps to provide descriptive analytics for power grids. Moreover, the efforts regarding the visualization of the GridLAB-D's simulation results and a prototype implementation are described. GridLAB-D despite the fact that is one of the most prominent tools for power grid simulations lacks a user friendly graphical interface. For this, we extend the GridLAB-D platform by introducing a visualization layer. This layer provides visualization of the simulation results using techniques based on diagrams while Self-Organizing Maps are used to provide an in depth descriptive analysis of the results.

Finally, we should make clear that the proposed web application is by no means complete. Many additions and improvements could be considered. Therefore, this

work may be considered as an on-going effort towards a modern, effective and user friendly generic visualization layer for GridLAB-D.

Chapter 5

Machine Learning

5.1 Introduction

The smart power grid ought to involve smart consuming appliances and intelligent energy producers that strategically place bids in a short term energy market. It is widely accepted that such smartness cannot be easily incorporated solely as hardware in the consuming and producing devices during the manufacturing time. Therefore, the recent research efforts that focus on software solutions to add intelligence to the smart grid are well justified. Such task is surely not trivial as in the stochasticity traditional involved in the energy consumption next generation power grids added stochasticity from the producers site through the integration of the distributed producers (renewable energy sources). This double stochasticity together with emerging market mechanisms and other more traditional issues make the task of adding intelligence to the grid in general a challenging issue and adding strategies on producing and consuming energy even more difficult.

We contribute to the efforts of smartening the smart grid by developing micro-learning (see section 5.2.2 for details) procedures that utilize weather data to train producing and/or consuming devices to strategically place bids. Our methodology, although simple, has the potential to be rather effective, in terms of the economic benefits of the energy market participants. These learning algorithms that reside in every device consuming or producing power and turns it in a strategic consumer and/or producer. This leads to what is known as distributed artificial intelligence in the smart grid.

Before we put any trust in our machine-learning procedures and before even testing them in a real environment, we must first study them in an, as realistic as possible, simulation environment. For this we have developed algorithms that lead to a machine learning layer which we have integrated in a very comprehensive, detailed and widely used simulation power grid distribution network framework. This enable us to perform a series of experiments that involve very detailed energy producing and consuming configurations on a distribution network with more than 600 houses and several local energy renewable sources.

The rest of this chapter is organized as follows. In the next section we briefly give the basic concepts and issues on energy markets and learning methods that consist our background for the material presented in the sections that will follow. In Section 9.6 we present the basic recent studies that relate artificial intelligence in general and machine learning in particular with the intelligence associated with the price making and taking of the energy consumers and producers. Section 5.4 contains our specific efforts to develop a simulation engine that integrates machine learning modules with a state of the art electrical distribution grid simulation framework. Selected results from our realistic experimentation studies are given in Section 5.5. Our synopsis and future prospects can be found in Section 5.6.

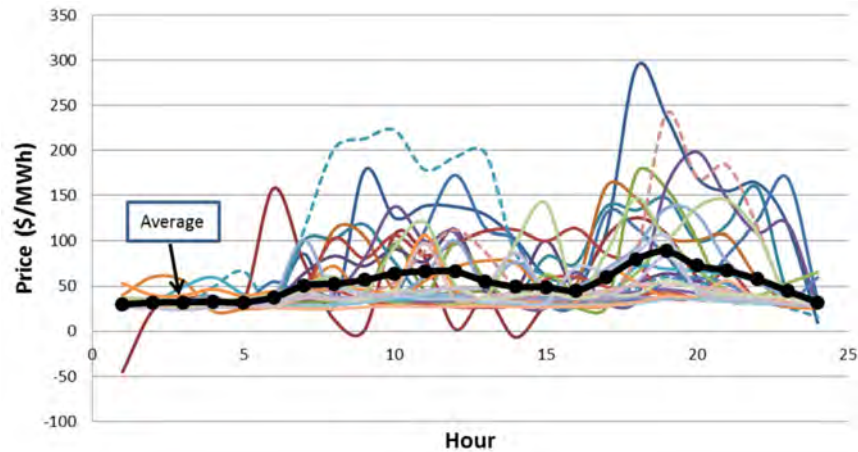

FIGURE 5.1: The 24 hour hourly PJM-reported local marginal prices at Newark Bay for every day in February 2013 (Source: <http://www.pjm.com>).

5.2 Energy Grids and Learning Methods

5.2.1 Next Generation Energy Grids and Markets

Smart grids have been a widely known concept that motivated several research, development and entrepreneurship efforts worldwide. It is foreseen that smart markets will follow the same routes. Smart price making in the consumption of electricity is important for the acceptance and the future of smart grids. Open and fair participation in the price making procedures could be established through learning procedures.

Fig. 5.1 clearly exhibits the price volatility as recently measured by the regional transmission organization PJM (<http://www.pjm.com>) that coordinates the movement of wholesale electricity in most states in the eastern coast of USA. It graphically depicts the difficulty of defining in advance any model of prices that will provide a good approximation of real-time prices. This leads to rapid economic transactions that require appropriate smartness.

Auction design is at the heart of the evolving energy markets. Based on theoretical models and practical considerations several efforts have been devoted to effectively predict the bid prices and quantities. These efforts utilize results from diverse thematic areas ranging from optimal power flow formulation, to economic models, to game theory, to artificial intelligence etc..

In addition to the design of several associated theoretical models, energy markets lead to the development of simulation systems that integrate the power flow equations with financial mechanisms. These systems allow us to elucidate several issues associated with both system and market stability in the emerging next generation grids where electricity flows along with measured data of various kinds. GridLAB-D [70] is such a system. It is an open source, detailed and comprehensive agent-based system that has been recently developed mainly in C++ and is widely used. For a recent study that utilizes GridLAB-D for large scale experimentations without learning in a way similar to the one we follow in the present paper, the reader is referred to [71].

5.2.2 Learning Methods

Machine learning has been commonly used in smart grids during the past decade. It allows us to smarten the grid in various ways including following:

Improving grid reliability. Machine learning algorithms are used to predict which grid components are more likely to have technical problems in the future, in order to be replaced with high priority.

Marketing related issues. An example in this direction are the efforts to learn to identify consumers willing to change provider.

Market improvements. A lot of efforts has been lately devoted in the implementation of learning algorithms with the aim of maximizing profits for electricity producers and minimizing costs for electricity consumers.

This work belongs in the latter category. To the best of our knowledge, our efforts are among the very few that focus on machine learning algorithms that aim on smartening the customers.

Machine learning algorithms are divided into two main categories, classification and regression algorithms depending on the value they assign to every observed instance. In classification algorithms the target value is categorical, while in regression the target value is continuous.

Relevance Vector Machine (RVM) is a probabilistic method both for classification and regression. RVM is a general Bayesian learning framework of kernel method for obtaining state of the art sparse solutions to regression and classification. RVM compared to Support Vector Machine (SVM) leads to significant reduction in the cost of computational complexity of the decision function and memory consumption of reconstructed predictive model, thereby making it more suitable for certain real time applications. Although RVM model conveys a number of advantages over the related and very popular SVM model, the necessary training procedure is typically much slower.

We should mention that the machine learning process considered in this study involves interactions with relatively tiny (micro-content) objects in small time-frames. As such it could be classified as micro-learning. Specifically, our learning procedure is based on:

- Interactions of elementary micro-content structures such as auction bids leading to pricing signals, under particular parameters of either climate or weather prediction data.
- Solving learning tasks that cover a span ranging from 15 minutes to a few seconds.
- Chaining in an iterative manner micro-actions like bidding decisions on energy demand and pricing, learning from clearing prices received and utilizing basic weather and climate prediction data.
- Utilizing repetitive, reflective and pragmatist learning types as well as corporate learning.

It is expected that micro-learning will open up new possibilities for just-in-time learning by introducing bite-size opportunities for cooperative electricity market solutions in general.

5.3 Related Work

RVM have been already attract the attention of several researchers in the area of electricity pricing signal (e.g. [72]–[74]). The majority of all related works found focus on day-ahead predictions. Below we briefly present the ones that are closely related to our work.

The main goal in [75] is to effectively charge batteries placed on the grid using a reinforcement algorithm. It considers a grid topology which includes solar arrays and a set of batteries and proposes and implements an algorithm for charging the latter using either the energy produced locally by the former or by drawing from the main grid when the renewable energy sources are not sufficient. The energy withdrawn from the main grid is more expensive compared to the energy produced by the solar arrays so the main objective of this work is the reinforcement learning algorithm to be able to charge the batteries when renewable energy sources are available so as to reduce the total energy cost.

[76] present efforts to develop a Dynamic Bayesian Network capable to forecast the aggregated water heater load of a residential area. The DBN is trained using both environmental data, such as outdoor temperature and solar radiation, and device specific data such as the efficiency of the water heater.

While the first two consider problems and develop solutions similar to our work, [77] is the closest related. It presents the design of a smart agent for controlling the heat-pump thermostat. It implements a reinforcement learning algorithm. The agent implemented is deployed in a simulated house, which is unknown to the agent in advance. During the first three days the agent explores the effects each action of the thermostat has on the house. After this random exploitation the agent uses a regression learning algorithm to fit the transition function that models the house in which the agent operate. The smart agent uses this algorithm to control the thermostat while reducing the energy consumed and keeping the occupants' comfort level unchanged.

All three of papers mentioned above utilize the GridLAB-D simulation environment. Simulation data are used for training the machine learning algorithms as well as validating the implemented algorithms. Nevertheless, none of them take into consideration market prices.

In the present work our goal is to implement smart agent controlling the heating, ventilating, and air conditioning (HVAC) system of a house while minimizing the cost of the energy consumed. This goal is met by implementing a regression algorithm forecasting the market prices. The market price encapsulates information about the availability of renewable energy sources so except for the reduction in the cost of electricity for every house our algorithm prompts the HVAC system to use preferably energy produced by solar panels or wind turbines.

[78] contains the basic idea of learning automata that influenced our work. These learning automata are used by the producers to maximize they profits. Assuming that a producer's bid p is m times higher than the true marginal cost p_0 , a learning automaton is applied to determine the appropriate value for m which represents the bidding strategy of the producer.

In [79] the idea of the "main agent" is presented. The main agent is part of each player participating in the market. It cooperates with negotiating agents, each of which contains the knowledge to perform a unique methodology based on variant approaches and techniques. The main agent implementing a reinforcement learning algorithm is responsible for choosing the most profitable proposal submitted by the

negotiating agents, based on its past experience. This paper utilizes the MASCEM electricity market simulator for testing and validation purposes.

Finally [80] present the entity of the “Broker Agent” which buys electricity from producers and sells it to consumers and its objective is to remain always in a balanced and profitable state.

5.4 Learning in GridLAB-D

In this work, we propose a machine learning regression algorithm for predicting the next market clearing price. This algorithm is trained with historical data containing market clearing prices and associated meteorological data and its objective is to enable both consumers to reduce their energy consumption cost, (while keeping the occupants’ comfort level unchanged compared to practices with no particular strategy), and producers to maximize their profit. For the implementation of our machine learning algorithm we used an RVM regression trainer object from dlib C++ Library [81] combined with a radical basis kernel. We trained a relevance vector machine for solving the regression problem of predicting the next clearing price of the market. The outcome is a decision function that represents the learned regression function.

We consider two variations of current simulation scenario where 629 houses, large and small wind turbines and a set of solar panels are connected together and to the power grid via an IEEE-13 distribution feeder. Every house appliance and every producing element participate in the auction that leads to market clearing every 15 minutes. Simulation data are used to train the machine learning algorithms. For every market clearing they include market clearing price, wind speed and solar radiation. Our algorithms learn to predict price variations related to variations in the meteorological data. Every market clearing during the simulated period is a training example. The training data contain current market clearing prices, wind speeds and solar radiation that was observed during the previous market clearing. If p_t is the market clearing price in simulation time t , s_{t-1} the solar radiation and w_{t-1} the wind speed observed during the previous market clearing, then the structure of each training example is:

$$\langle s_{t-1} | w_{t-1} \rangle \rightarrow p_t \quad (5.1)$$

For the implementation of the above described decision functions we have extended the functionality of three GridLAB-D modules following their agent based realization and according to the micro-learning approach described above. Specifically we have modified:

- The market module, which contains controllers for the consuming appliances and the generators and is responsible for calculating the bid price and for submitting it to the auction market. In this module we have incorporated a function call to our decision function which returns the predicted market clearing price for the next market clearing. We allow that either the consumers or the producers or both to use this returned value. The consumers use this predicted value in order to stop their operation if the value is greater than the highest value of the marginal costs of the renewable sources. The generators use this value so as to bid in higher prices than their marginal cost when the predicted market price is higher than this marginal cost.

- The generators module, which is responsible for simulating the producers. We have modified this module adding capabilities to accept a marginal cost for each generator. This marginal cost is the initial bidding price of each generator.
- The residential module, which implements houses with various appliances. In the module we have changed the house component in order to be able to change the heating and cooling set points when the controller of the HVAC system takes the decision to stop operating because the renewable source available will not be sufficient and therefore the market clearing price is expected to be too relatively high.

The overall goal is to minimize the costs associated with drawing additional (and costly) energy from the main grid, due to temporary variations in the energy generated by the renewable sources.

5.5 Experimentation

Machine learning is nowadays so pervasive that we often use it for a wide range of our daily activities. Nevertheless, before putting much trust in our machine learning applications we need to learn about not only its theoretical underpinnings, but also gain the practical know-how needed to apply particular techniques to energy markets.

For this we have designed a collection of experiments that may be categorized into sets in various ways. For example according to the renewable energy sources considered.

All simulations are conducted under certain weather conditions, namely using typical weather data that have been recorded in Seattle, USA by the US National Renewable Energy Laboratory, given in a TMY2 format.

Details of the particular distributed energy sources considered in our experimental studies can be obtained from http://gridlabd.me.uvic.ca/wiki/index.php/Generator_Module_Guide. Their elements used in our experiments and their attributes are summarized in Table 5.1. The marginal cost prices for each local producer and the grid, given in the third column, are based on the continuously updated report *Levelized Cost of Electricity—Renewable Energy Technologies*, a study by the Fraunhofer ISE, in Germany, November 2014 edition.

TABLE 5.1: Power sources and their characteristics.

Acronym	Type	Marginal Price (€/per KWh)	Capacity (KWh)
LWT1	Large Wind Turbine	.16	2.5
LWT2	Large Wind Turbine	.14	2.5
SWT	Smaller Wind Turbine	.18	1.5
SLP	50 Solar Panels (30m ² each)	.12	2.5
GRID	The power Grid	.30	-

Our experiments use the IEEE-13 bus test feeder depicted in Fig. 5.2. This is a short and relatively highly loaded feeder that contains a substation voltage regulator, overhead and underground lines, with variety of phasing, shunt capacitor banks, in-line transformer, unbalanced spot. We have distributed the houses and

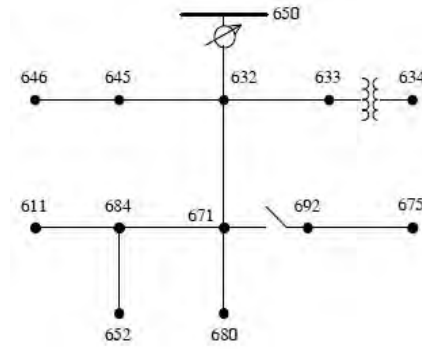

FIGURE 5.2: The IEEE-13 test feeder.

the local renewable energy sources on most of the nodes and we connect our feeder to the power grid through node 650.

To examine the effectiveness of our learning algorithms and their implementations, and to elucidate the affect of the various configuration parameters on the overall market behaviour we have performed a total of twelve experiments, We denote them with the acronyms $EX_i, i = 1, \dots, 12$.

These experiments may be categorized in two sets according to their grid configuration. Half of them involve only wind turbines while the others involve both wind turbines and solar panels. The former involve three wind turbines, two of them large and a smaller one. Their attributes can be found in Table 5.1. For the experiments involving both wind turbines and solar panels, we have two large wind turbines and fifty solar panels.

The first four experiments involve no learning. EX_1 and EX_2 are experiments that cover the first week of August. EX_1 simulates a grid containing only wind turbines while EX_2 simulates a grid containing wind turbines and solar panels. Data resulting from these two experiments are used to train our learning algorithms and consequently develop the bidding strategies of both producers and consumers. They are not presented here.

All other experiments cover the period from the 9th till the 19th of August. EX_3 and EX_4 do not involve learning and the participants bid at the clearing prices given in Table 5.1. EX_3 and EX_4 consist the base cases to which we will compare the experiments with a grid containing only wind turbines and a grid containing both solar panels and wind turbines respectively.

The last eight experiments are the experiments involving learning in a way depicted in Table 5.2.

TABLE 5.2: The various experiments and their characteristics

	EX_3	EX_4	EX_5	EX_6	EX_7	EX_8	EX_9	EX_{10}	EX_{11}	EX_{12}
Wind turbines only	✓		✓		✓		✓		✓	
Solar panels + Wind turbines		✓		✓		✓		✓		✓
One consumer only			✓	✓						
One consumer + All producers					✓	✓				
All consumers							✓	✓		
All consumers + All producers									✓	✓

In Fig. 5.3 we compare the air temperature of the house before and after applying to the HVAC system the learning algorithm. We can see that during day time when

cooling occurs the behaviour of the HVAC system is almost the same in both cases. This happens because during day time except for the wind turbines that produce energy when there is sufficient wind speed also the solar panels produce electricity. This causes the market prices to be lower so our algorithm does not find it necessary to stop the HVAC operation. There are only few violations during day time, these violations occur during those days that the solar radiation is very low or wind speed is low or both of them happen simultaneously.

On the contrary during night time the violations are quite often. This happens because during the night there are also those time intervals that the wind speed is low but also the solar panels do not produce any electricity. During night time only the wind turbines produce energy from renewable sources, so the prices are higher. This causes our algorithm to stop the operation of the HVAC system rather often.

In Table 5.3 we observe that our smart consumer pays 14% less when her HVAC bids according to the machine learning algorithm in the *EX5* where three wind turbines produce electricity, while in *EX6* where solar panel and wind turbines produce electricity our consumer pays 7% less. The percentage is higher in the first case because the marginal prices of the producers in the first case are higher than the marginal prices of the producers in the second case.

We also made the producers able to use the price forecasting algorithm. We used the naive approach of the methodology presented in [78] with which the producers bid at forecasted prices this algorithm calculates. If the forecasted price is higher than its marginal cost the producer increases the submitted bid price. If it is lower than its marginal cost the producer submits its marginal cost as it does without applying our algorithm.

The difference between *EX5* and *EX7* is that we have added knowledge to all producers, the same knowledge. In Table 5.3 we see that SWT has increased remarkably the load it sells in the market while the mean price for every KW it sells in the market is the same in both experiments (0.20€/per KWh). On the contrary LWT1 has increased its mean price for every KW sold from 0.14€/per KWh to 0.15€/per KWh but the total earnings for this wind turbine have decreased. This has happened because LWT1 has the lowest marginal cost among all the wind turbines, so increasing the bid price it submits in the market although it leads to increased mean price of the electricity sold it causes smaller amount of electricity to be sold because the price offered by LWT1 reaches the price offered by the other wind turbines in the market. These results confirm the fact that the regression algorithm implemented is very accurate in identifying the time slots during which the market clearing price will be above 0.18, which is the highest price offered by a producer offering energy produced by renewable sources. The earning of the second wind turbine have increased drastically because the price offered by this wind turbine is the threshold above which energy is drawn by the main grid.

In Fig. 5.4 we observe how the clearing prices vary during the ten day simulation period for *EX9*, *EX10*, *EX11*, and *EX12*. In these experiments all consumers and producers are able to use the machine learning algorithm. We have restricted y-range in our graphs to a maximum of 0.5. We should mention though that there are cases where the market clearing price is 9999€/per kWh. These are the cases depicted with clearing prices larger than 0.3. They represent market failures often observed in many related studies. Such market failures are due to unresponsive buyers. All seller quantities fail to meet the highest buyer bid requirements. This is the reason why in Table 5.3 the earnings of the producers are increasing remarkably where learning is added in all consumers. During the time slots that our algorithm predicts that the market clearing price will be high all HVAC systems postpone their

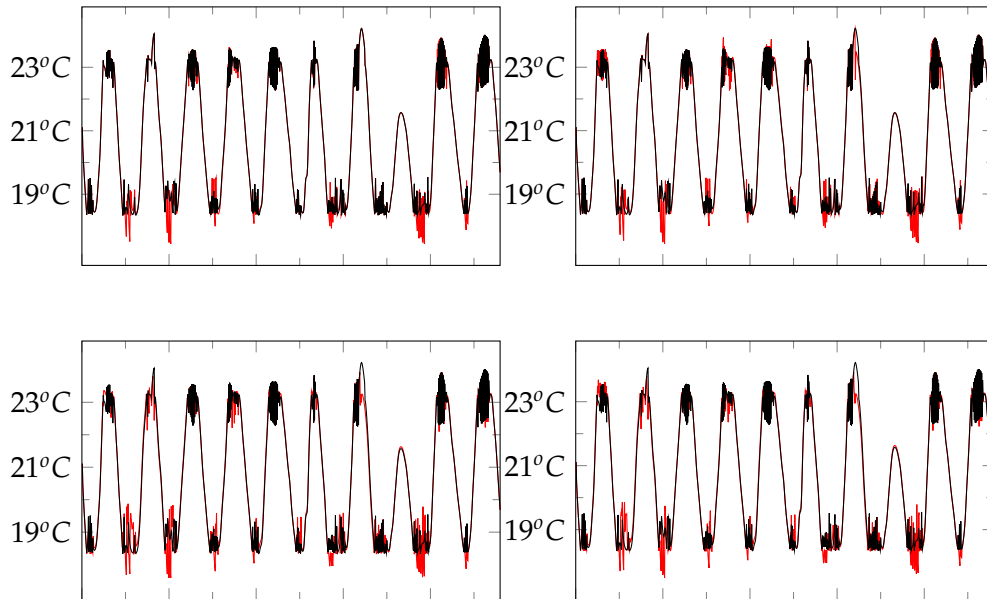

FIGURE 5.3: House temperature variations in the presence of wind turbines only. No-learning data are represented in black colour and learning in red. EX5, EX7, Ex9 and EX11 are associated with top left, top right, bottom left and bottom right accordingly.

TABLE 5.3: Total price paid or earned (in €) and total quantity bought or sold (in KW) for the various experiments

	EX3		EX5		EX7		EX9		EX11	
	€	KWh	€	KWh	€	KWh	€	KWh	€	KWh
House	71	453	61	415	68	442	75	368	81	398
LWT1	211,328	1,473,270	211,328	1,473,270	138,123	901,432	261,228	1,439,577	239,369	1,267,502
LWT2	25,432	150,390	25,432	150,390	26,787	153,124	205,050	1,043,965	208,651	1,061,074
SWT	2,997	13,298	2,997	13,298	4,967	22,964	68,861	276,685	71,544	289,752
	EX4		EX6		EX8		EX10		EX12	
	€	KWh	€	KWh	€	KWh	€	KWh	€	KWh
House	58	419	54	405	55	411	69	369	76	396
LWT1	133,626	924,535	133,626	924,535	114,617	768,825	245,053	1,326,205	244,689	1,275,830
LWT2	16,549	92,535	16,549	92,535	17,104	91,328	174,011	822,615	181,028	830,052
SLP	1,472	11,695	1,472	11,695	1,207	9,195	2,076	11,598	2,095	11,360

operation. When the price falls back in ordinary rates all HVAC systems request electricity from the market as uncontrollable load because the air temperature of the house has overcome the maximum or minimum bound. They may be prevented by operator actions but this is a subject beyond the scope of our study. The reader is referred to <http://gridlab-d.sourceforge.net/wiki/index.php/Spec:Market> for in depth discussion on the above matters.

All experiments have been performed on a DELL Precision desktop PC with two Intel Xeon 6-core 2,27GHs processors. Each one of the ten experiments associated with the learning results presented above takes less than a couple of wall-clock hours while the overhead due to the learning procedure is minimal.

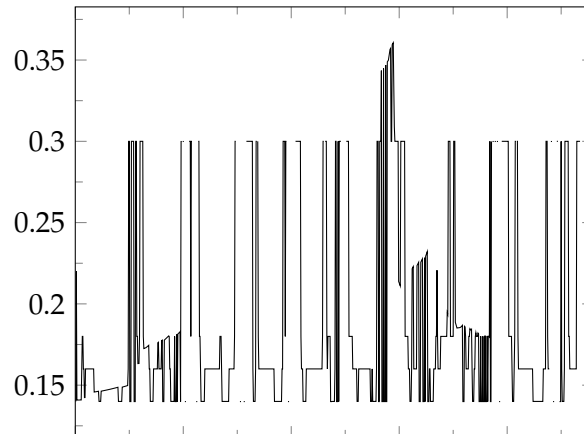

FIGURE 5.4: Clearing Prices when all consumers use machine learning algorithm

5.6 Synopsis and Future Prospects

This chapter provides a mechanism that allow consumers and producers place they bids using a machine learning approach. Experimental results justify that this approach could affect the market characteristics both positively and negatively. The latter is apparent when every market participant uses the same, and therefore known to everybody, strategy. Therefore, it is apparent that we need to add individualism in the learning strategies. We believe that this could be achieved by blending machine learning with game theory and we already moving in this direction.

Furthermore, our study may be extended in several directions, including (but not limited to) the following:

- Although we focus on residential consumers only the extension to commercial or industrial ones (where even better improvements are foreseen) seems to be feasible, if not straight forward.
- So far we consider producers and consumers. Our approach could be even more effective in the case of prosumers, entities that act both as consumers and producers either in cooperative or reselling manner. In such a case we could easily follow the work of [80].
- Utilize machine learning services offered over the cloud, like the the Microsoft's Azure Machine Learning, IBM's Watson Analytics and Amazon's Machine Learning.

Please note that all the code associated with our study is available at <https://github.com/mafoti/LearningConsumersProducers> while all experimental data produced can be found at <https://plot.ly/~magda/LearningConsumersProducers>.

Chapter 6

Utilizing Game Theory

6.1 Introduction

Game theory classifies the games into two branches, the non-cooperative and the cooperative ones. As stated in [82] non-cooperative theory could be better stated as procedural, while cooperative as combinatorial. That is because in non-cooperative games players choose an action among the available actions they have, while in cooperative games the outcome depends on the combinations players make when they collaborate. The game proposed and utilized in this chapter can be classified as non-cooperative because players choose their strategy without communicating with each other. Because of this, our algorithm implementing this game can be developed in a distributed manner, where each player can calculate the load to be consumed based on information available to him/her. This could be a very desirable feature in certain cases with large number of consumers. The game theoretic approach presented in this chapter is compared with the approach presented in chapter 5.

6.2 Related Work

The associated research literature resulted in a wide range of work related to game theoretic energy consumption. Out of them we would like to highlight the following [83], [84], [85], [86], [87], and [88]. Please note that all the above have been published in the past few years and are representatives of the wave of game theoretical studies in power systems.

All of the above mentioned works formulate non-cooperative games among energy consumers. The main objective of these works is the cost reduction for the consumers but also the reduction of peak-to-average ratio in load demand. [83], [84], [85], [86] and [87] use smart home scheduling to evenly distribute the demand over the time horizon. In each of the above papers, consumers' strategy is the consumer's demand vector. The vector that represents the consumer's demand for a given number of timeslots for which the game takes place. These papers use game theory to balance the total demand considering this certain time horizon. A game takes place usually in a day ahead manner and consumption is balanced based on consumers' needs and preferences.

These approaches are useful for appliances such as water heaters and dish washers that can schedule their consumption in next day's timeslots based on user settings. In our experiments we use HVAC systems. The difference in the consumption profile between HVAC systems and dish washers is that an HVAC system runs continuously and turns on and off frequently based on the house air temperature and the outdoor temperature, while the operation of the dish washer can be scheduled usually based only on a user setting that is the time by which the dishes must be

clean, or the operation of a water heater which is based on a user setting that describes the time by which the water must be hot.

While the papers presented above consider problems and developed solutions similar to our work, [88] that develops a pricing based demand response mechanism is the closest related to our approach and our grid's configuration. Specifically, the Nash equilibrium of the non-cooperative game between the consumers is aligned with the equilibrium in the demand response. The equilibrium in the demand response is found based on the pricing elasticity. In the present work the non-cooperative game formulation is very close to the formulation presented in [88] but we also develop a supply prediction algorithm to match supply with demand. In our work the equilibrium in demand response is based on demand elasticity.

6.3 Game Formulation

We consider a grid consisting of several producers and a large number of consumers. We assume that the consumers have access to a regression algorithm that predicts the amount of the available energy. Each consumer is also equipped with an energy management controller, which enables the HVAC system to schedule its energy consumption.

The energy consumption of consumer i at time slot t is denoted by l_i^t and $0 \leq l_i^t \leq l_i^{t,max}$. $l_i^{t,max}$ is the amount of load needed by the HVAC system based only on the current air temperature of the house, the outdoor temperature and the thermal characteristics of the HVAC system, without taking into consideration the available energy supply. l_i^t is the energy consumption of consumer i in time slot t based on the non-cooperative game results. l_i^t is also the strategy of player i in the game at time t .

Following [88] we define the payoff function as:

$$U_i(l^t) = -LR_i(l_i^t) - p(l^t)l_i^t, \quad \text{where } 0 \leq l_i^t \leq l_i^{t,max} \quad (6.1)$$

$LR_i(l_i^t)$ denotes the cost of reducing the energy consumption from $l_i^{max,t}$ to l_i^t and $p(l^t)$ is the electricity price at time slot t when the total load consumption by all consumers at time slot t is l^t .

The non-cooperative game is modeled as:

$$G = \{N, S_i, U_i(l)\} \quad (6.2)$$

where N are the consumers participating in the game, S_i are all the possible strategies of player-consumer i and $U_i(l)$ is the payoff function.

We use the Taguchi loss function [89] to calculate the cost of changing the load the HVAC will consume, and as a result the house temperature. Taguchi loss function is defined as:

$$L = k(y - m)^2 \quad (6.3)$$

where L is the loss in money, y the quality characteristics, m the target value for y and k is a constant coefficient.

The value of k can be found if we solve the above function substituting y with $m \pm \Delta_o$ where Δ_o is the distance between current value y and the target value m .

$$k = \frac{L}{\Delta_o^2} \quad (6.4)$$

The cost of changing the HVAC set points is calculated by the function:

$$LR_i(T_i^n(t)) = k(T_i^n(t) - T_i^{in,target}(t))^2 \quad (6.5)$$

where $T_i^{in,target}(t)$ is the target indoor temperature and $T_i^n(t)$ is the indoor temperature if the HVAC system consumes reduced load, l_i^t rather than $l_i^{t,max}$, in time slot t . The function that calculates the house indoor temperature changes according to the following function, which gives the connection between the load consumed and the evolution of the temperature [90].

$$T_i^{in}(t) = T_i^{in}(t-1) + \beta(T_i^{out}(t) - T_i^{in}(t-1)) + \gamma l_i^t. \quad (6.6)$$

Parameters β and γ specify the thermal characteristics of the appliance and the environment in which it operates. The second term in equation 6.6 models the heat transfer while the third term models the thermal efficiency of the system. Using the above function, we can compute the house air temperature in accordance with the load that will be consumed in time slot t . For the house to reach the desired temperature the HVAC system must consume $l_i^{t,max}$. Substituting function 6.6 to the load reduction function 6.5 we get:

$$LR_i(l_i^t) = \kappa\gamma^2(l_i^t - l_i^{t,max})^2 \quad (6.7)$$

Substituting the above function to the payoff function 6.1 we get:

$$U_i(l^t) = -\kappa\gamma^2(l_i^t - l_i^{t,max})^2 - p(l^t)l_i^t \quad (6.8)$$

6.3.1 Nash Equilibrium

A Nash equilibrium in the game is a game solution, in which no player has an incentive to unilaterally change his/her strategy [91]. When all the players have chosen strategies and no player can benefit from changing his/her strategy while others maintain their strategy, then the strategies selected by all players and the corresponding payoffs are a Nash Equilibrium. In order for the game described to have a unique Nash Equilibrium, the pricing function must be linear and rotational symmetric [88], so we formulate the following pricing function:

$$p(l^t) = \lambda \sum_{i \in N} l_i^t \quad (6.9)$$

where λ is a parameter that implements the demand elasticity of the N consumers.

Substituting function 6.9 to the payoff function 6.8 we get:

$$U_i(l^t) = -\kappa\gamma^2(l_i^t - l_i^{t,max})^2 - (\lambda \sum_{i \in N} l_i^t)l_i^t \quad (6.10)$$

The Nash equilibrium is the point where the first derivative of the payoff function 6.10 with respect to l_i^t is equal to zero. That is

$$2\kappa\gamma^2(l_i^t - l_i^{t,max}) - \lambda l_i^t - \lambda \sum_{i \in N} l_i^t = 0 \quad i \in N \quad (6.11)$$

We add the above function 6.11 for all the consumers to obtain the total load. The addition gives us:

$$\begin{aligned}
2\kappa\gamma^2 \sum_{i \in N} l_i^t + 2\kappa\gamma^2 \sum_{i \in N} l_i^{t,max} - \lambda \sum_{i \in N} l_i^t - \lambda N \sum_{i \in N} l_i^t &= 0 \\
\sum_{i \in N} l_i^t &= \frac{2\kappa\gamma^2 \sum_{i \in N} l_i^{t,max}}{2\kappa\gamma^2 + \lambda(N + 1)}
\end{aligned} \tag{6.12}$$

where $\sum_{i \in N} l_i^t$ is the total demand by all consumers in timeslot t . In the next section we describe the supply prediction algorithm we have developed so that the HVAC systems are able to predict the energy that will be available by the wind turbines in the next timeslot. By matching the predicted supply with the demand at the Nash Equilibrium we obtain the demand elasticity value of the parameter λ at the Nash Equilibrium.

Based on the above equations we conclude that consumers can compute the load to consume in the Nash Equilibrium knowing only the total energy demand of all consumers. The consumers do not need to communicate with each other and exchange information to reach Nash Equilibrium.

6.3.2 Supply prediction algorithm

We create a regression algorithm, which is used to predict the available supply from the wind turbines in the next time slot. The algorithm is trained using historical data. Each training example contains the wind speed of the previous time slot and the energy produced by the turbines in the current time slot. The structure of each example is may be described as

$$w_{t-1} \rightarrow \sum_i^n s_t^i \tag{6.13}$$

where w_{t-1} is the wind speed during time slot $t - 1$, n is the number of wind turbines connected to the grid and s_t^i is the energy produced by wind turbine i at time slot t . During simulation time, given the current wind speed, we use this algorithm to predict the total available supply in the next timeslot.

In Figure 6.1 we see the effectiveness of the supply prediction algorithm in the two different grid configurations used in our experiments. On the top of Figure 6 we see the effectiveness of the algorithm when applied on a grid containing only wind turbines and on the bottom we see the effectiveness of the algorithm when it is applied on a grid containing both wind turbines and solar panels.

6.4 Experimentation

To examine the price paid by consumers and the money earned by producers when consumers formulate the non-cooperative game described in previous section 6.3 we have performed two experiments. We denote them with the acronyms EX_{13} and EX_{14} . The results of these experiments are compared with the results from experiments contacted in the previous chapter. In Table 6.1, and for the sake of completeness, we present the characteristics of all the experiments performed and described in Chapters 5 and 6.

Taking a close look in Figure 6.3a we can see that when all consumers have access to the prediction algorithm they take decisions uniformly. This is the reason why in

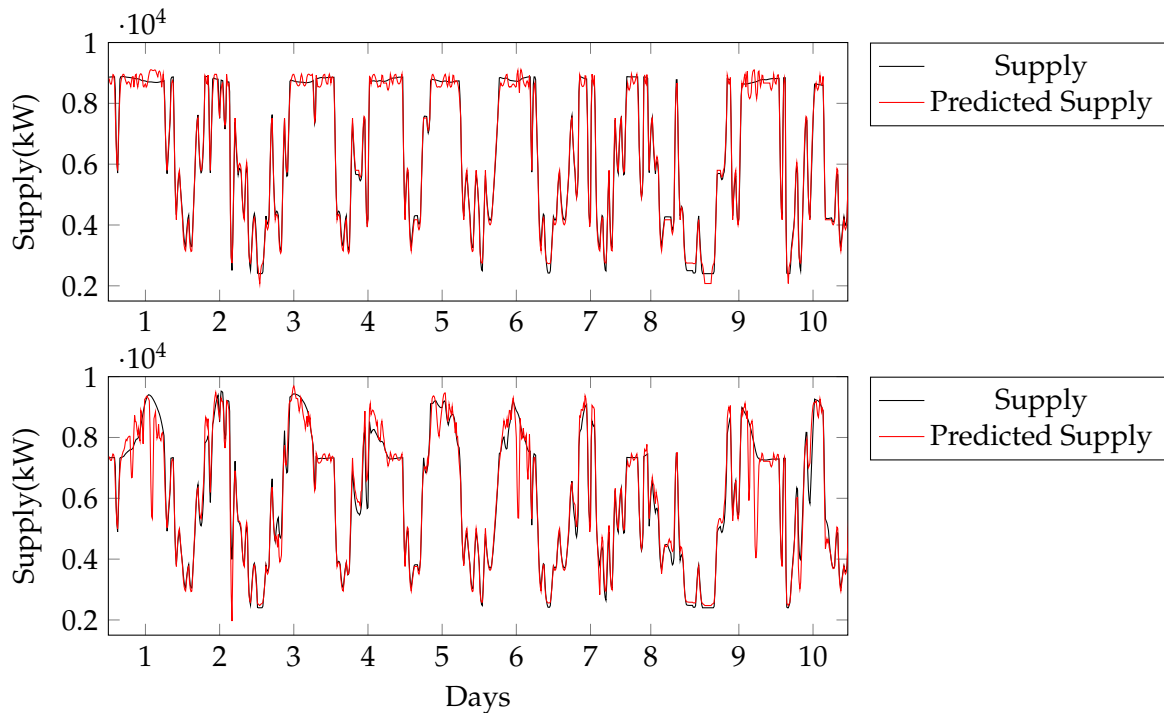

FIGURE 6.1: Supply prediction. Supply from wind turbines (top) and wind turbines and solar panels (bottom).

TABLE 6.1: The various experiments and their characteristics

	EX ₃	EX ₄	EX ₅	EX ₆	EX ₇	EX ₈	EX ₉	EX ₁₀	EX ₁₁	EX ₁₂	EX ₁₃	EX ₁₄
Wind turbines only	✓		✓		✓		✓		✓		✓	
Solar panels + Wind turbines		✓		✓		✓		✓		✓		✓
One consumer only			✓	✓								
One consumer + All producers					✓	✓						
All consumers							✓	✓				
All consumers + All producers									✓	✓		
Non-cooperative Game											✓	✓

Figure 6.3a we can realize that in many time slots the demand is zero and the peak demand has increased considerably. In time slots with zero demand the consumers know that the prices would have been high if no one of them had access to the prediction function, and they all decide to postpone their operation for a few time slots. This behavior results in great variations of the demand and the consumers end up paying more. This happens for two reasons:

- During the timeslots that were predicted to be expensive the demand is zero and this results in a very low price that no one takes advantage of.
- In the subsequent timeslots the temperature in the houses has violated the comfort zone of the residents. This results in a very high demand in those time slots, which in turn results in high prices and peaks in the demand as it is clearly depicted in Figure 6.3a. During these peaks the price is high as shown in Figure 5.4.

In Figure 6.3b we can compare the data from the default operation with the data associated with the utilization of the non-cooperative game among consumers. In

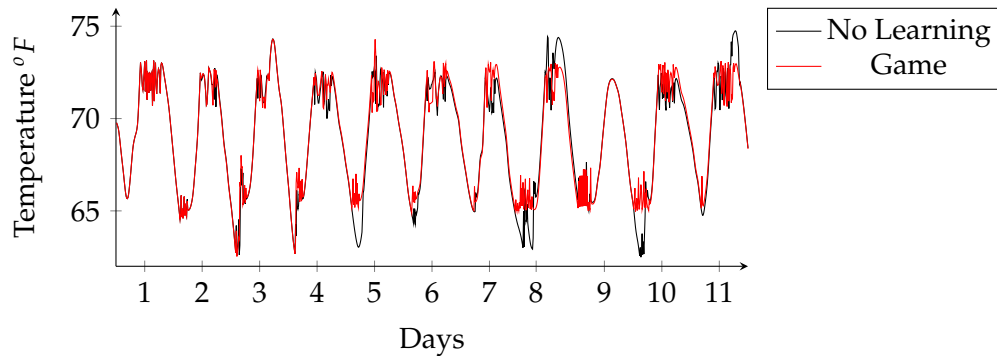

FIGURE 6.2: House temperature variations in the presence of wind turbines only.

this case we can see that we no more have the so frequent time slots of zero demand and the associated demand peaks disappear. This happens because the non-cooperative game tries to match demand with supply and consumers do not take decisions based on price. This configuration gives better results because one of the game's objectives is to match supply with demand.

It is interesting to notice that load shifting is also a result of the game. When the supply is low HVAC systems change their settings so as to operate consuming less energy instead of turning off. When supply raises and HVAC systems need to operate, based on residents' comfort zones, they can take advantage of the available supply. This load shifting happens both by increasing the off peak demand and without increasing peak demand.

Comparing the results from the game with the case where all consumers avoid high prices presented in Figure 6.3c we observe that the total demand is more evenly distributed among time slots. This is also an advantage of the game theory approach because high variations in the demand affect grid reliability negatively. High variations may result in technical problems and grid components' failures.

In Figure 6.2 we compare the house air temperature during EX_3 and EX_{13} . When consumer takes part in the non-cooperative game between all consumers, residents' comfort zone is more strictly met. This happens because the load that the HVAC requires is more evenly distributed among the time slots that the HVAC system operates.

In Table 6.2 we will first compare the results from experiments that have modified all consumers' behavior. Comparing EX_9 with EX_{13} we see that when all consumers participate in the game they end up paying less than in the default scenario, while when all consumers avoid high prices they end up paying more. We come to the same conclusion by comparing EX_{10} with EX_{14} . An interesting observation is that the amount of energy withdrawn from the main grid is less at the experiments where consumers avoid high prices compared to the experiments that implement the game. This is due to the fact that when consumers avoid high prices they postpone their operation while in the game they reduce the amount of energy they consume. But as we will see later, the strategy of completely avoiding these timeslots results in increasing the peak to average ratio of the grid.

In Table 6.3 we observe three of the most critical characteristics that affect the grid's steady state operation. These three characteristics are peak and average demand and their ratio that is the peak to average ratio (PAR). We see that when consumers are able to avoid high prices the peak demand increases considerably while

TABLE 6.2: Total price paid (in €) or earned (in million €) and total quantity bought (in KW) or sold (in million KW) for the various experiments

	EX ₃		EX ₅		EX ₇		EX ₉		EX ₁₁		EX ₁₃	
	Kw	€	Kw	€	Kw	€	Kw	€	Kw	€	Kw	€
House	5042	12.47	4998	11.90	5230	13.09	5550	13.13	5477	13.55	4611	11.10
LWT1	16.19	2.35	16.19	2.35	16.53	2.48	16.68	2.37	16.32	2.43	16.39	2.31
LWT2	4.83	0.75	4.83	0.75	4.88	0.79	4.31	0.63	4.44	0.70	3.59	0.52
SWT	1.52	0.25	1.52	0.25	1.63	0.28	1.24	0.18	1.40	0.23	1.05	0.15
GRID	3.80	0.74	3.80	0.74	3.95	0.79	2.20	0.34	2.66	0.51	2.40	0.37
	EX ₄		EX ₆		EX ₈		EX ₁₀		EX ₁₂		EX ₁₄	
	Kw	€	Kw	€	Kw	€	Kw	€	Kw	€	Kw	€
House	5214	11.07	5199	10.71	5360	11.74	5874	12.17	5824	12.71	4575	9.72
LWT1	10.73	1.51	10.73	1.51	11.32	1.67	10.82	1.49	10.50	1.53	12.89	1.82
LWT2	3.42	0.50	3.42	0.50	3.49	0.55	2.94	0.43	2.74	0.42	2.62	0.44
SLP	6.0	0.75	6.0	0.75	6.54	0.84	6.62	0.81	6.47	0.83	7.81	0.97
GRID	4.03	0.73	4.03	0.73	4.12	0.80	2.41	0.43	2.46	0.46	2.81	0.61

TABLE 6.3: Demand Characteristics

	Wind Turbines						Wind Turbines & Solar Panels					
	EX ₃	EX ₅	EX ₇	EX ₉	EX ₁₁	EX ₁₃	EX ₄	EX ₆	EX ₈	EX ₁₀	EX ₁₂	EX ₁₄
PAR	1.73	1.73	1.72	2.39	2.36	1.95	1.87	1.87	1.78	2.56	2.63	1.74
Peak	2879	2879	2943	3693	3704	2894	2863	2863	2863	3688	3687	2880
Average	1663	1662	1705	1543	1567	1480	1527	1526	1609	1440	1401	1651

the average demand decreases. This behavior leads to increased PAR in these experiments.

When the non-cooperative game is formulated among consumers, peak demand is equal to peak demand we observe at grid's default operation. The average demand gives two different results, in the first grid's configuration when we have connected only wind turbines to the grid it decreases while in the second where we have connected wind turbines and solar panels it increases. This happens because the game tries to match supply with demand. This results in the following two different situations. In the first configuration PAR is increased due to the decreased average demand while in the second is decreased due to the increased average demand; both are a result of the available supply.

All experiments have been performed on a DELL Precision desktop PC with two Intel Xeon 6-core 2,27GHs processors. Each one of the ten experiments associated with the learning results presented above takes less than a couple of wall-clock hours while the overhead due to the learning procedure is measured to be minimal.

6.5 Synopsis and future prospects

In this chapter we use game theory to add individualism to the market participants' strategies. We formulated a non-cooperative game among energy consumers. Experimental results show that this approach solves the problems that arose from the approach presented in chapter 5. The demand peaks disappeared and the consumers use available energy more efficiently, while reducing the cost of HVAC operation.

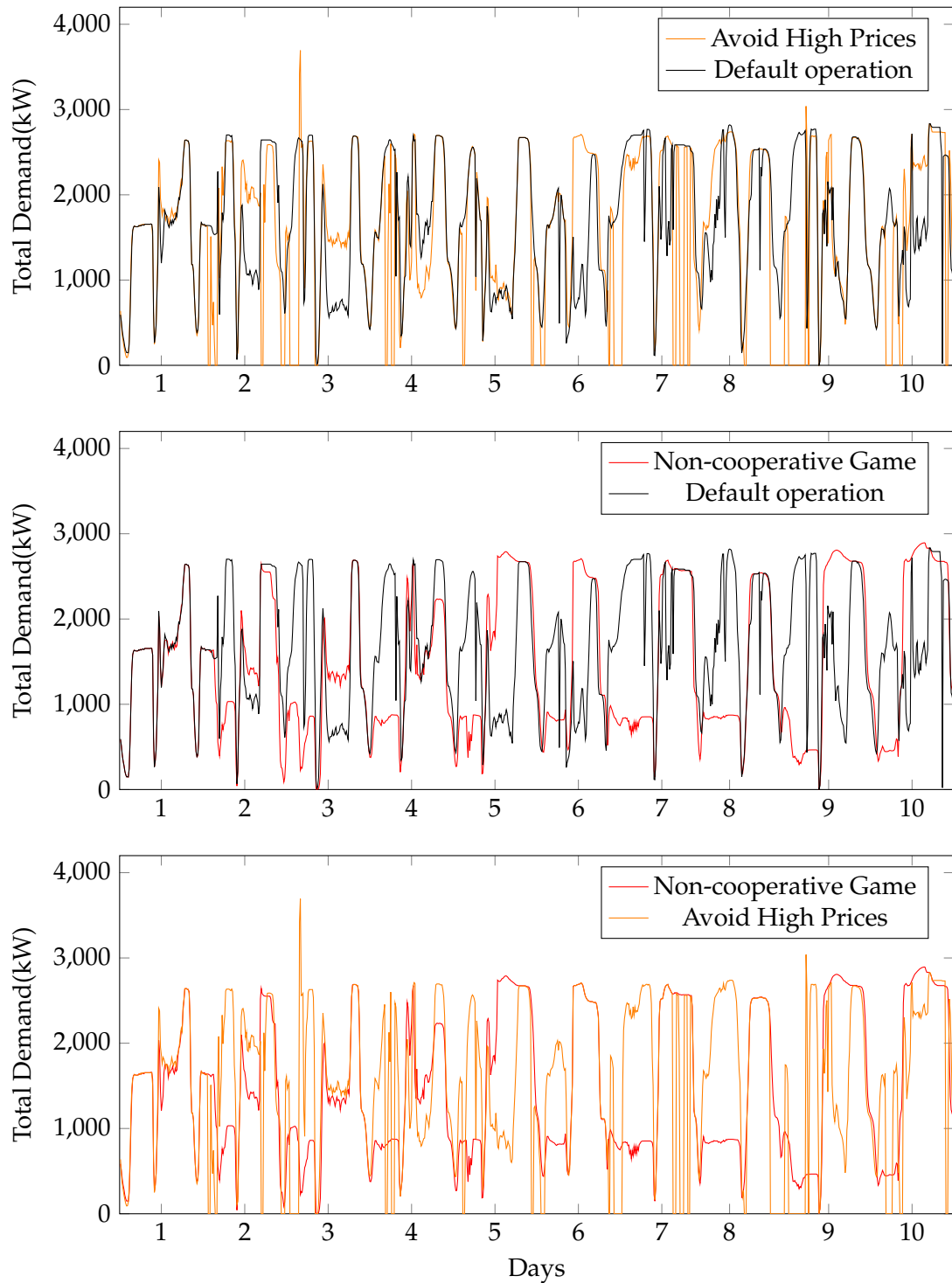

FIGURE 6.3: Consumers' total demand.

Our study is by no means complete. It may be extended in several directions, including (but not limited to) the following:

- A double non-cooperative game approach could be implemented, following the general idea presented in [92].
- The extension to commercial and/or industrial consumers seems straightforward.
- Our approach could be even more effective in the case of prosumers.

Please note that all the code associated with our study is available at <https://github.com/mafoti/NonCooperativeGame> and <https://github.com/mafoti/LearningConsumersProducers> while all experimental data produced can be found at <https://plot.ly/~magda/folder/magda:486>.

Part III

Towards Decentralized Operation

Chapter 7

What Blockchain can do for Power Grids?

7.1 Introduction

The aim of this review section is to present existing and emerging ways in which the energy industry can exploit the methodology and practice of the Blockchain technology. Our goal is to present efforts coming both from the scientific community and from industry.

In particular, we understand that the current as well as the emerging energy price generation environment leads to a substantial change in the whole energy industry, posing significant and diverse challenges. We believe that Blockchain, both as a concept and as a technological background, can be part of the solution to various challenges, helping both the companies to pursue their profitability in the energy market arena and the independent user communities to work towards common energy benefit. This chapter may also be considered as a brief synopsis and annotation in principle of the possibilities of coupling energy with crypto-currencies and Blockchain in particular.

The basic value of the Blockchain is directly related to the concept of trust. Blockchain is a decentralized database that allows people and organizations to interact without having to trust each other. They have the ability to trade with, for example, money without participating banks or any other brokerage organization, as is the case with conventional transactions. Because of this, the Blockchain is expected to change the way we perform global value transactions. Therefore, it is important to explore what this new technology can offer in the energy sector. In other words in this work we will focus on energy transactions, and power grid operation in general, instead of money transactions.

Although, we almost exclusively consider the power grid, we believe that the facts presented and the lessons delivered, as well as the concluding remarks apply to other sectors as well, with no particular difficulty.

The rest of this chapter is organized as follows. In the next section we provide the basic concepts and develop the required background on Blockchain and the next generation power grids and the challenges they both pose. Section 7.3 contains a review of related papers that recently appeared in scientific journals after peer review. In section 7.4 we briefly overview the associated EU funded projects and in section 7.5 other related major and promising efforts. Our concluding remarks can be found in sections 7.6.

7.2 Power Grids and Blockchain

In recent years we have been monitoring the evolution of power grids in intelligent networks and lastly what is called the grid edge.

The truly interesting changes that drive developments in the electricity sector occur at the edges of the network, where the consumer meets the grid, competes with it, disrupts it and generally acts in ways that test its traditional mode of operation.

The most important changes that are already happening on the network are:

- Production is more interrupted due to an increase in the share of renewable energy sources.
- Transmission and distribution become more controllable and fault tolerant due to network digitization.
- Consumers have the dual role of both producer and consumer.
- Loads become more interactive and dynamic.

These changes challenge the traditional way in which utility companies operate. These companies are called upon to respond to change and adapt.

Although it is still early, it is worth asking ourselves whether the technology of Blockchain can play an interesting role in recent and emerging energy developments. The expected role will be of further interest due to the two-way relationship between energy trading and the energy cost of running the Blockchain algorithms. These algorithms are based on evidence (such as Proof-of-Work) which in turn requires the necessary energy use. By way of example, we report that in 2014 energy consumption was \$ 240 kWh per bitcoin [93]. In addition, these energy costs are almost always paid in a non-cryptographic currency, introducing a steady downward pressure on the price. The energy cost of consensus algorithms of modern crypt coins (like Proof-of-Stake and Proof-of-Capacity) is several thousand times smaller, but remains a very important parameter. Also, they are considered highly immature especially for public networks, compared to Proof-of-Work that is used to handle transactions worthing billions of USD every day.

Blockchain is a distributed system that provides trust among counterparties. It allows the creation of distributed peer-to-peer networks, where members of no confidence can interact without a trusted intermediary in a verifiable way [94]. Using Blockchain microgrids can be made more robust by using a distributed database, in the form of a common accounting book, to manage transactions. This resilience may also be related to the strengthening of these networks in the face of electronic attacks and the strengthening of them on the solidarity side. These transactions may include transactions in electricity, money transactions or even the recording of electron flow in the network [95].

It is also our deep conviction that Blockchain technology can make a significant contribution to the development of local energy communities [96]. The creation of these communities is a priority for many countries.

7.2.1 Review of reviews

The number of reviews published during the last two years, including [97] [98] [99] [100] and [101], prove that blockchain activities in the energy sector move fast. These reviews come from advisory companies and this is mainly because there is a lot of activity coming from start-up companies and big technology firms.

This study aims to contribute to the body of knowledge of blockchain technology within energy sector. The main contribution of the current work is that it conducts a systematic study both on the research trends and the entrepreneurial efforts in the intersection of energy industry and blockchain technology.

7.3 Related peer-reviewed publications

TABLE 7.1: Categorization of peer-reviewed publications

Subject	refs
Power Flow	[102] [103] [104]
Emission Reduction	[105] [106]
Energy Markets	[107] [108] [109] [110] [111] [112] [113] [114] [115] [116] [117] [118] [119] [120] [121] [122] [123] [124]
Batteries	[125] [126]
Demand Response	[127] [128]
Electric Vehicles	[129] [130] [131] [132] [133] [134] [135] [136] [137]
Security and Privacy	[138] [139] [140] [141] [142] [143] [144]
Other	[145] [146] [147] [148]

Blockchain has been mainly considered in the gray literature. As graphically depicted in Figure 7.1, only recently blockchain studies have appeared in peer-review articles. In this section we present the largest volume of the work published in recent years, trying to categorize them according to the main subject addressed. The result of the categorization is shown in Table 7.1

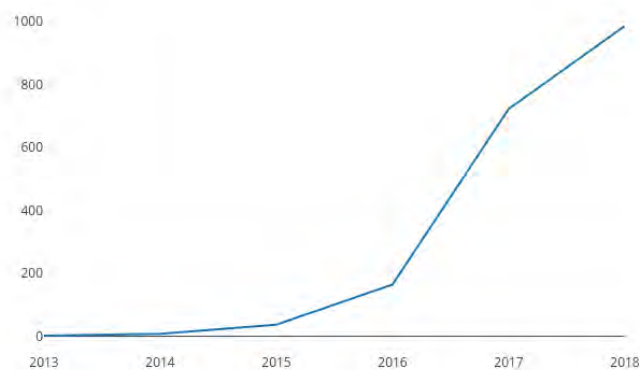

FIGURE 7.1: Number of publications per year retrieved from Scopus using "blockchain" as keyword search (results retrieved on 02/09/2018).

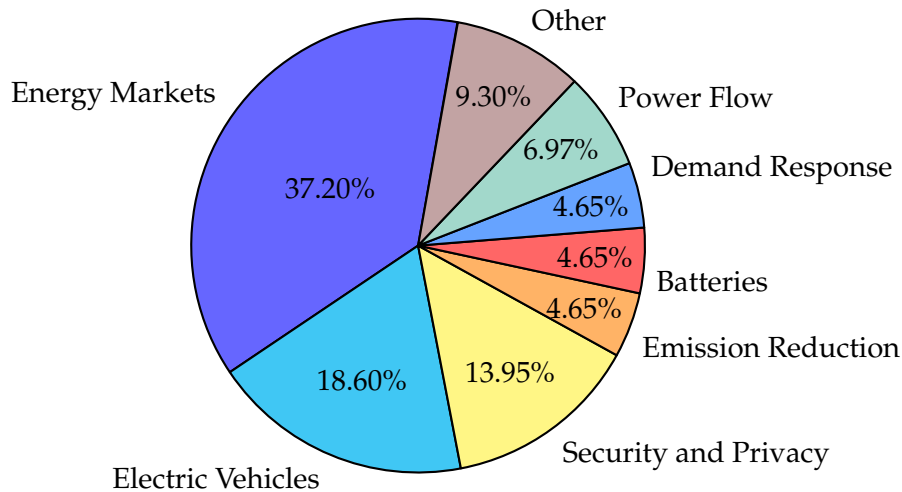

FIGURE 7.2: Peer-reviewed publications

7.3.1 Power Flow

The work in [102] presents an architecture for the operation of a P2P energy market which respects the physical constraints placed by the grid while maximizing social welfare. Authors use blockchain to coordinate devices and facilitate the aggregation step of the decentralized optimal power flow algorithm they have used. Distributed energy resources perform a local optimization step and send the results of this step to a smart contract. This smart contract serves as a coordinator, executing the last step of the algorithm which is the aggregation of the local optima. They consider a day-ahead scheduling problem. The implementation is based on a smart contract deployed on a public test Ethereum network.

[103] uses Blockchain and Alternating Direction Method of Multipliers to solve the optimal power flow problem in a distributed way. While [102] has used a smart contract for the aggregation step of the OPF solution [103] has used the consensus algorithm to find a solution accepted by all power grid nodes.

[104] employs a smart contract to achieve voltage regulation on an LV distribution grid. The distribution grid consists of several microgrids. A local DER from every microgrid is elected as voltage regulator through the smart contract for every control period. This DER is given incentives to operate below capacity and provide voltage regulation.

7.3.2 Emission Reduction

[105], [106] and [149] study the use of blockchain technology for emission reduction in power grids. More specifically [105] proposes a new Emission Trading Scheme(ETS). This ETS uses blockchain to face system's management and fraud issues while it incorporates a reputation system to improve the overall efficacy. Multichain is used as blockchain implementation. [106] focuses on Guarantees of Origin (GoO). Authors have developed an Energy Token Market using the Ethereum Blockchain and a Smart Contract deployed on it. The objective of the Smart Contract is to allow people trade crypto tokens that mimic GoOs. [149] proposes a blockchain system for green certificate management and energy monitoring.

7.3.3 Energy Markets

In [107] a market design framework is introduced. This framework consists of seven fundamental components for the efficient operation of blockchain based microgrid energy markets. These seven components are: microgrid setup, grid connection, information system, market mechanism, pricing mechanism, energy management trading system and regulation. The Brooklyn Microgrid project was used as a case study and was evaluated according to the seven required components as they were introduced by the authors.

[108] [109] [110] [111] and [112] focus on P2P energy markets. More specifically, [108] presents an M2M electricity market where two electricity producers and one electricity consumer are trading with each other over a blockchain. The proof-of-concept implementation is presented in the context of chemical industry and the physical machines are replaced with simulations of industrial processes. MultiChain is used for the creation and deployment of a private blockchain. In [109] energy sellers form a coalition and they participate in the market as a single entity while buyers place their bids separately. Electricity market mechanism is defined in a smart contract which is deployed on an Ethereum network. [110] studies local P2P energy communities and determine the properties these communities must have, regarding the metered data, in order to reach social and market acceptance. A design for energy communities is proposed that ensures accuracy, traceability, privacy and security. Authors in [111] compare the unit price of electrical energy provided by P2P energy simulations to the prices that are currently set by conventional power generation companies. Also, the time to recuperate the initial investment to create a smart home is calculated. Finally [112] designed a framework for a distributed energy market.

In [113], [114] and [115] authors go beyond the economic aspects of energy transactions and present their concerns on how feasible P2P energy transactions are since they depend on the voltage distribution across the network. [113] presents an application that annotates energy losses to each energy transaction between a generator and a load while [114] studies the issue of power flow tracing and suggests a way to compute reactive injections. Finally [115] gives more technical details on how the concepts presented in [113] and [114] can be implemented on a blockchain network.

Local Energy Markets (LEMs) based on blockchain are implemented in [116] and [117]. Authors try to answer the question whether blockchain technology is suitable as LEM's main ICT technology. A private blockchain and artificial agents were used to present a proof-of-concept. A smart contract implements the market mechanism, which is a uniform price double auction. Simulations with up to 100 households are presented.

In our previous work [118] we implemented an energy market with the same characteristics as the one described in [116]. We compared different implementations trying to minimize the computational and monetary needs for the operation of this real-time uniform price double auction energy market. The conclusion of this work was that the monthly cost for each market participant is not negligible if the market is deployed on the public Ethereum network.

In [119], a double auction energy market based on blockchain is presented. In contrast to [116] and [117] presented earlier, [119] implements a P2P energy market, where consumption bids are matched with generation bids. Different trading strategies that can be adopted by market participants are discussed but this is something implemented externally to blockchain.

[120] also describes a P2P energy market, where 5 smart contracts were implemented for the operation of the market. The first smart contract take care of transaction processing in the call auction stage, the second determines each user's demand, a third one schedules the orders, the fifth is responsible for the matchmaking in the continuous double auction stage, while the fifth is the implementation of the transaction settlement process.

[121] designs local energy markets to enable active participation of small energy producers. These markets operate in a distributed way using blockchain and avoiding the need for a central authority. Authors consider the existence of EVs in the microgrid and demand response programs that provide flexibility.

Helios, a solar energy distribution system is presented in [122]. Helios is a system that operates on an Ethereum network utilizing a smart contract. The smart contract is designed to operate as a market controller and allow a microgrid to work in either in island mode or connected to the main grid. Smart meters communicate with the smart contract which generates coins for the solar energy produced and makes the payments for the energy consumed.

A smart contract that implements a Vickrey second price auction is introduced in [123]. The smart contract is deployed on a private Ethereum network and is responsible for the operation of an energy market, collecting bids from prosumers and executing the payments.

[124] presents a trading platform for buying and selling tokenized energy.

7.3.4 Batteries

[125] focuses on the potential, for energy consumers, of battery storage in a local P2P energy market. More specifically, authors evaluate the benefits end-users get in a market design where they are able to exchange P2P energy and houses have the possibility to either use a privately owned battery or a community owned battery. Results show a reduction in the electricity bill up to 31%

[126] proposes a concept for efficient sharing of battery systems between neighbors using a blockchain based distributed controller. The results show that they achieve an increased self-sufficiency while reducing the load of the grid. The implementation is based on permissioned Ethereum network and Proof-of-Authority is used as the consensus algorithm.

7.3.5 Demand Response

In [127] data acquired from metering devices are stored as energy transactions on the blockchain. A smart contract is deployed for each distributed energy prosumer (DEP) enrolled in the demand response program proposed by the authors. These smart contracts check the compliance of each DEP to the desired energy profile, calculate the associated rewards and penalties and decide the definition of new demand response events. The validation of the proposed model was done through a simulation of a grid with 12 DEPs using energy traces of UK building datasets. Ethereum protocol was used for the operation of the P2P network and smart contracts were written in Solidity.

[128] describes a non cooperative game theoretic algorithm among consumers and a utility for demand side management (DSM). The implementation is based on blockchain, namely Zig-Ledger is used for the creation of a consortium blockchain,

and smart contracts are developed for the realization of the distributed DSM application. As authors point out, the advantages that emerge from blockchain technology is that more participants can enter the market and operating costs are reduced.

7.3.6 Electric Vehicles

[129][130][132][133][134][135][136] and [137] study and present possible applications for electric vehicles in a blockchain enabled grid. [129] describes an electric vehicle charging system that includes both a prioritization and a cryptocurrency component. The two components are used to provide incentives to EV users to collectively charge in times with high RES generation. The prioritization component gives non-monetary incentives while cryptocurrency component gives monetary incentives to users. Non-monetary incentives include user saving time and having more flexibility to choose time to charge over other users. Blockchain is used for the implementation of the cryptocurrency component. [130] propose a system for localized P2P electricity trading among plug-in hybrid electric vehicles. The authors propose the utilization of a consortium blockchain to accomplish trustful and secure electricity trading. An iterative double auction mechanism is used to specify the price and amount of energy transactions while maximizing social welfare and protecting privacy of PHEVs. In [131] authors present an optimal charging scheduling framework for EVs. Unlike other scheduling algorithms, author take into account the existence of mobile charging vehicles. A consortium blockchain is utilized also in this work to provide security and privacy to the electricity trading operation. The evaluation of the proposed algorithm has been done using real charging pile data from Beijing. [132] aims to improve voltage stability of the grid while minimizing charging costs for EV users. An adaptive blockchain-based electric vehicle participation scheme is proposed to schedule EV charging/discharging demand in order to flatten the impact of consuming/injecting excess amount of energy at the level of transformer substation. [133] outlines a model for electric vehicle charging. This model incorporates lightning network and a smart contract to implement registration, scheduling, authentication and charging phases of a vehicle. A security analysis is presented and authors claim that the model meets the security goals set. In [134] authors propose a platform that integrates electrical vehicles and charging stations and enables a negotiation between them over blockchain. [135] recommends a distributed application for electric vehicle charging, preserving vehicle owner's privacy. A smart contract allows vehicles to signal their demand and receive offers by charging stations using predefined regions without revealing their exact location. [136] provides results of using Ethereum state channels in the context of an application for an electrical-cars charging company. In particular the presented implementation records and handles the charging process and payments. In [137] the main focus is the design of a lightweight blockchain client that can handle billing process.

7.3.7 Security and Privacy

[138][139][140][141][142] and [143] focus on security and privacy issues arising in blockchain based energy systems and propose solutions. [138] and [139] attempt to explore the application of blockchain and smart contracts to improve smart grid cyber resiliency and secure transactive energy applications. Authors claim that the combination of PNNL's Buildings-to-Grid Cyber Testbed and the connected campus is a realistic environment for the simulation of blockchain applications for transactive energy. The simulations in such a realistic environment will help improve

the state of the art and use blockchain to create a more resilient grid. In [140] a system that provides transparency, provenance and immutability is proposed. According to the authors, this system will solve the issue of customer's data manipulation and customers' ignorance on the details of their energy usage profile. The blockchain based system proposed is based on a blockchain network and a smart contract. [141] uses multiple authority attribute-based signature to protect the privacy of a microgrid's data. The approach proposed allows users to exchange data making it impossible for other entities to modify or misuse these data. In [142] and [143] authors focus on the privacy preservation issue that comes with the use of the distributed ledger technology on the transactive grid. They claim that transaction level data provide greater insights into prosumer's behavior compared to smart meters. In [142] a trading workflow called PETra (Privacy-preserving Energy Transactions) is presented. PETra is build on distributed ledger technology and proven techniques for anonymity, such as mixing services, randomly generated anonymous addresses, anonymous communication identifiers and onion routing. In [143] authors describe how the communication and transaction mechanisms of PETra can be extended to provide anonymity. The solution they propose is the use of garlic routing and ring signatures. The combination of the two methods provides anonymity on the whole chain of transactions both on the network communication layer and on the distributed ledger transaction layer. [144] study a distributed energy management application in terms of security. An number of different attack types were considered and finally a digital identity management algorithm was proposed. The application is a distributed application based on a smart contract deployed on an Ethereum network.

7.3.8 Other

[145] is a review article, presenting blockchain based projects with application on microgrids. Authors focus on start-up approaches and attempt to technically compare them. [146] lists a number of case studies in which blockchain technology could be used to provide benefit to the power grid while [147] illustrates the effectiveness of blockchain and big data technologies on solving the issues Energy Internet faces today. Finally [148] studies the application of blockchain and smart grid technologies in the context of a smart city.

7.4 Horizon 2020 Projects

The EU through Horizon 2020, its financial instrument coupling research and innovation, has been systematically supporting the penetration of the blockchain technology into the energy sector. This section is devoted to associated projects. In Table 7.2 we present the basic characteristic of these projects. We provide our brief description for each one of them right after.

P2P-SmartTest [150] is an already completed Horizon2020 innovation action project. In [157] authors, in the context of the project, present a review of the existing P2P Energy Trading Projects. The conclusions of the review include the belief that blockchain is considered to be a very promising technique which can simplify the metering and billing system of the P2P energy trading market.

CROSSBOW [151] stands for: CROSS BOrder management of variable renewable energies and storage units enabling a transnational Wholesale market. This

TABLE 7.2: List of EU supported projects.

acronym	purpose	start	end	refs
P2P-SmartTest	P2P trading	2015	2017	[150]
CROSSBOW	Energy markets	2017	2021	[151]
Future Flow	Balancing services	2016	2019	[152]
Defender	Security	2017	2020	[153]
eDream	Community energy systems	2018	2020	[154]
SealedGRID	Security	2018	2021	[155]
SOFIE	IoT	2018	2020	[156]

Horizon2020 project's main goal is the development and deployment of a set of technological solutions which will enable increasing the shared use of resources to foster transmission networks cross-border management of variable renewable energies and storage units. These solutions will enable a higher penetration of clean energies whilst reducing network operational costs and improving economic benefits of RES and storage units. In this project blockchain will be used in the implementation of the market platform. As it is mentioned in their web-page: a novel orchestrated multi-nodal market platform will be adapted and deployed, which will allow market players to integrate and interoperate on the distributed concepts with minimum set of harmonized technical and data requirements for market participation.

Future Flow [152] is a horizon 2020 research project. The stated objective of this project is to design and pilot test comprehensive techno-economic models for open and non-discriminatory access of advanced consumers and distributed generators to a regional platform for balancing and redispatching services. Blockchain is used in pilots of this project to study if the use of blockchain could allow for trusted information, such as device features, and standard compliance information to be published in an elegant, safe, and low-cost way.

Defender [153], a horizon 2020 innovation project, studies critical energy infrastructures' security, resilience and self-healing "by design". Defender will adapt, integrate, upscale and validate a number of technologies and deploy them within an integrated framework to address these issues. Blockchain is not at the center of this project, its technology will be leveraged for providing peer-to-peer trustworthiness.

eDream [154] is a research a horizon2020 project, with their first publication [127] discussed in previous section. eDream works on the redesign of traditional market approaches and smart grid operations. Their aim is the creation of novel decentralized and community-driven energy systems fully exploring local capacities, constraints and Virtual Power Plants-oriented optimization in terms of local and secure grid nodes stabilization.

SealedGRID (MSCA-RISE) studies security threats inherited to Smart Grid from the ICT sector, privacy issues and new vulnerabilities, related to the specific characteristics of the smart grid infrastructure. At the time of writing, no extra information related to this project is available.

SOFIE is based on the idea of using interconnected distributed ledgers as a cornerstone to build decentralized business platforms that support the interconnection of diverse IoT systems. The project promises to create three pilots in three different sectors: food chain, gaming, and energy market.

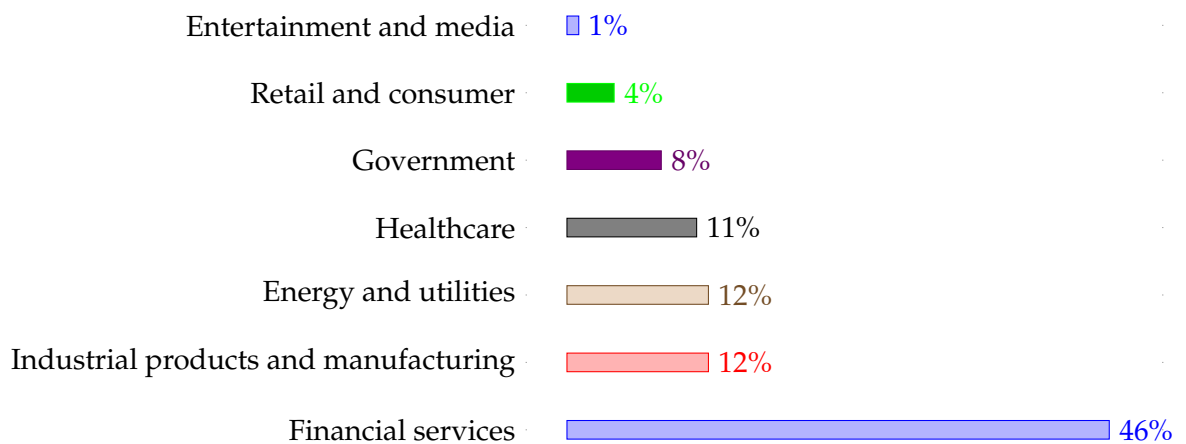

FIGURE 7.3: Industries developing blockchain today. Source [158]

7.5 Entrepreneurial efforts

In Figure 7.3 we can see the industries leading blockchain technology adaptation according to PwC Global Blockchain Survey [158]. Financial services are the leader in leveraging blockchain technology, while energy and utilities sector is the second most active sector together with industrial products and manufacturing.

In this section we present selected entrepreneurial efforts of the energy industry exploiting blockchain technology. In Table 7.3 we have summarized the characteristics of these entrepreneurial efforts.

Energy Web Foundation(EWF), a global non-profit organization, has built an Ethereum based client and a public test blockchain network. This client is Ethereum based and more specifically it is based on Parity implementation of Ethereum. The consensus algorithm used is Aura, a Proof-of-Authority algorithm. This network serves as an infrastructure for foundation's affiliates to build solutions and run use cases. PJM-Environmental Information Services recently joined EWF.

PJM-EIS is a wholly-owned subsidiary of PJM Connex, L.L.C., itself a subsidiary of PJM Interconnection. PJM Interconnection is the power grid operator and wholesale market administrator for a 13-state region of the United States serving 65 million people¹. The goal of this cooperation is the creation of a pilot, by the end of the first quarter of 2019, for the Generation Attribute Tracking System (GATS) administered by PJM-EIS. This pilot will use EWF's solutions based on blockchain and will allow PJM-EIS evaluate the potential benefits of blockchain technology to improve the security, transparency, and transaction costs of GATS.

Brooklyn Microgrid[159] is an energy project developed by LO3 energy and partners including Siemens AG and Centrica Innovations. This project is one of the first projects leveraging blockchain technology for P2P energy trading. The aim of this project is to study how the technology of blockchain can enable instant trading of solar energy between neighborhoods. More specifically, since April 2016, a pilot project runs in Brooklyn, which studies how buildings equipped with distributed energy resources can be integrated into a decentralized P2P electricity network. Five buildings, participating in the program, have installed photovoltaic systems on their top floor and produce energy. The amount of energy not consumed by these buildings is sold to five neighboring households. Buildings are connected through the

¹<https://tinyurl.com/yckw7q7j>

conventional power network, while transactions are managed and stored by a central system based on blockchain. Apart from Brooklyn Microgrid project LO3 has developed Exergy, a permissioned platform designed to create a democratized energy marketplace through facilitating participation using blockchain technology.

Power Ledger[160] has developed a private Proof-of-Stake blockchain named EcoChain. EcoChain is currently in use in trials, while a transition to a modified fee-less Consortium Ethereum network is under development. Power Ledger uses this private/consortium network to handle the transaction for P2P energy trading while public Ethereum blockchain is used to offer their POWR tokens to end users and exchanges. Power Ledger uses a second token named Sparkz, this token is issued against escrowed POWR tokens. Sparkz tokens are used by applications hosted on Power Ledger's platform. These applications include P2P trading, wholesale market settlement, autonomous asset management, electric vehicles and more, with each level of development varying from conceptual design to operational.

Electron[161], a U.K. based tech company harnessing blockchain to design new platforms and services for energy sector. Electron's main products, as they are presented in their web page, include a meter registration platform, a flexibility trading platform and community energy projects. At the end of 2017 Tokyo Electric Power Company (TEPCO) invested in Electron according to the press release[162]. The two companies state that together they will explore the potential to change the existing centralised structures to decentralised systems in energy transactions. However, this was not the first time TEPCO invested in a blockchain startup company. In 2017 TEPCO signed a memorandum of understanding with Grid+. This cooperation aimed at exploring how blockchains can enable peer-to-peer power transactions.

Grid+[163] is building a hardware and a software stack. A smart agent that stores cryptocurrencies, processes payments and programmatically buys and sells electricity and a software stack making the payments. Short term plans include the operation of Grid+ as an energy retailer. Compared to current retailer Grid+ claims to lower variable costs, enable real-time payments and offer lower prices to consumers. Long term plans include enabling dynamic pricing computing real-time dynamic distribution costs, P2P markets and integration of wholesale market in the retail market. Grid+ has issued two cryptotokens, BOLT and GRID. BOLT is a stable currency with each BOLT being redeemable for \$1 worth of energy on the Grid+ platform. GRID token were sold in a token sale, every GRID has the right to purchase 500 kWh of electricity at the wholesale price available to Grid+ platform. Grid+ plans to work on Ethereum future Raiden network.

WePower [164] introduces itself as a blockchain-based green energy trading platform. WePower enables energy tokenization, energy producers can issue energy tokens which represent energy they commit to produce and deliver. These tokens can be seen as a contract between energy producers and consumers. WePower platform wants to build through energy tokenization a global energy market and improve the currently existing investment ecosystem.

Verv[165] is developing a platform for trading at the grid edge. P2P trading will occur inside local communities. Trading will be executed on private blockchain networks, one for each community. Local community ledgers will publish a digest of all transactions to the public Ethereum ledger on a daily basis. All transactions taking place on Verv's trading platform will be conducted using VLUX tokens, while the daily digest of data to Ethereum public ledger will include transaction fees paid in Ether. Verv wants to differentiate its self from other efforts by combining blockchain with data analytics, machine learning and IoT.

Irene [166] is not a trading platform but an electricity supplier. Irene buys electricity from producers, at market prices or at the price they are entitled to, and sells it back to consumers at Irene's retail tariff. Energy consumers can freely choose the energy producers from which they wish to energy from. Irene guarantees to the participating producers that all their available energy will be purchased. If the energy is not purchased by the participating consumers Irene sells the excess amount of energy back to the grid at wholesale price. The main difference between Irene and other efforts is the fact that Irene has used Stellar blockchain implementation. Tellus token is used inside Irene network and Stellar's option to customize tokens so they can meet AML compliance regulation is used.

Lition[167] is a licensed energy supplier in Germany how has build a decentralized energy market based on blockchain. Lition serves more than 700 households across Germany and in partnership with SAP is building a proprietary blockchain solution. Lition's main focus is on P2P energy transactions between consumers and producers directly, avoiding all the intermediaries. Also Lition pays special attention in consumers data privacy. Lition is expected to launch its ICO in 2019 which will sell tokens on the ethereum public network.

Enosi[168] is a not-for-profit organisation that leverages the distributed ledger technology to transform the energy industry. Enosi aims to combine smart metering data with distributed ledger technology and provide new protocols and actors' roles to energy market participants.

Share&Charge [169] is an open network developed by MotionWerk and its partners. It works on a decentralized digital protocol for electric vehicle charging. Share & Charge introduces a way for P2P car charging based on Ethereum BlockChain. Consumers will be able to control smart charging poles using an application without the intervention of an intermediary. Share&Charge goal is to offer a fully automated, global authentication, billing, and pricing solution without an intermediary. Share&Charge1.0 was based on Ethereum's public blockchain network but due to challenges faced described in this post[170] Share&Charge2.0 will be based on a consortium blockchain network. Main obstacles faced on public network include transaction fees and pending transactions.

SolarCoin[171] is a digital currency. The owner of a solar system, when joining SolarCoin network is eligible to receive a 1 SolarCoin, from SolarCoin Foundation, for each 1 MWh of solar electricity produced. SolarCoins can be used as digital currency or they can be traded for government currencies (fiat) on global cryptocurrency exchanges. SoloarCoin is a cryptocurrency that mimics GoOs. SolarCoin has its dedicated blockchain network. The implementation is based on a fork from Litecoin source code

Intelen, a Greek company, in cooperation with University of Piraeus, are currently implementing a system for peer-to-peer exchange of energy between prosumers, using blockchain technology. This system will be a part of Intelen's digital platform, and will enable consumers to participate in real time energy markets. All peer-to-peer transactions will be certified through blockchain technology, and special digital wallets will also be used, which will be interconnected with the loyalty system of Intelen's platform [172].

7.6 Concluding remarks

Apart from a few first implementations, the applicability of Blockchain to the power grid is still largely theoretical. At this stage, some early participants are designing

TABLE 7.3: List of Entrepreneurial efforts. Market Capitalization of May 2018

	Platform	Token	ICO	Market Cap	refs
LO3	Exergy	Exergy	-	-	[159][173]
PowerLedger	Ethereum	POWR, Sparkz	\$34m	\$167.01m	[160]
Electron	Ethereum	-	-	-	[161]
Grid+	Ethereum	GRID, BOLT	\$40m	\$19.41m	[163]
WePower	Ethereum	WPR	\$40m	\$47.21m	[164]
Verv VLUX	Ethereum	VLUX	Expected	-	[165]
Irene	Stellar	TLU	Expected	-	[166]
Lition	Ethereum	LITION	Expected	-	[167]
Enosi	Ethereum	JOUL	Expected	-	[168]
Share&Charge	Ethereum	-	-	-	[169]
SolarCoin	Litecoin	SLR	-	\$14.71m	[171]
Intele	-	-	-	-	[172]

power and device authentication systems. But for the most part, the scientific community is trying to find out how the technology of Blockchain could be used and how we can overcome the barriers for large scale adoption. In other words, the question must be answered, is Blockchain the technology that will make a decisive contribution to the completion of the so-called energy transition? Some answers that the community of people working on Blockchain and Smart Grids has attempted to do is the following:

Why Blockchain?

- Fast, cheap, secure and transparent transactions between multiple members.
- Autonomous distributed trading markets with low operating costs and almost instantaneous conciliations and settlements.
- A "no confidence" system without the need for intervention or interpretation by any contractor.

What are the benefits of using Blockchain in the energy sector?

- Enhanced finance for distributed energy systems and battery storage.
- Solve the split-incentive problem with multi-owner properties.
- Increases the value utilization and therefore the value of network assets.
- Easier access to low cost electricity.
- Reduces wastage of power in transmission.
- Provides a platform for generating or saving sharing power.

The fact that the needs of the electricity grid, such as those encountered with the entry of an increasing number of renewable sources, coincide with the possibilities offered by the technology of Blockchain makes us believe that its use in the energy sector has a lot to offer. One element that reinforces this view is the fact that over the last two years many new businesses have been created and consortia have been formed between big companies from the energy sector and newcomers to study these possibilities and create products. Primarily, these efforts focus on implementations that include peer-to-peer energy trading and pricing applications.

Chapter 8

Blockchain Based Uniform Price Double Auctions for Energy Markets

8.1 Introduction



FIGURE 8.1: Enabling Components for Transactive Energy Networks.

This section rides on top of two technology waves, the Distributed Ledger Technologies (DLTs) in general and the Blockchain technology in particular and the next generation power grid, also known as the smart grid. In particular, we envision next generation power grid systems that are based on distributed nearly real-time demand response models and associated markets that utilize the blockchain concept and technology, while they operate under the conventional power control mechanisms. The components of the envisioned transactive energy networks are graphically depicted in Figure 8.1.

Transactive energy systems, as a generalized form of demand response, focus on real-time, autonomous and decentralized systems, able to take decisions [174]. In this section we study certain important characteristics of the blockchain

technology and examine their appropriateness for such transactive energy systems and in particular energy markets.

The three main ways through which DLT is transforming the systems of finance are Digitalization, Decentralization and Democratization. We argue that these characteristics can be decisive enabling factors, allowing power grid transformation to achieve its goals. We also believe that DLTs will allow us to address issues smart grids face today, such as Byzantine fault tolerance [175] in smart grid communication, the operational costs of the energy markets, the protection of the privacy and the strengthening of the cyber-security of the smart grid.

Several efforts for developing P2P trading of energy using blockchain already exist, not in a fully operational mode yet. In this section, we implement a uniform price



FIGURE 8.2: Uniform Price, Double Auction Market Clearing.

double auction mechanism, graphically depicted in Figure 8.2, based on blockchain for the operation of energy markets. Furthermore, we propose different approaches for this implementation examining their capabilities through a series of large scale simulations. To the best of our knowledge, our work is the first attempt to run large scale simulations and systematically compare a decentralized energy market based on blockchain with the corresponding centralized implementation.

We propose three different approaches for implementing both the P2P network as well as the associated market mechanisms. In these approaches we gradually move computation from the smart contract and the P2P network to the local machines running the blockchain client. All the approaches are based on smart contracts deployed on a consortium P2P network. We compare the results of each approach with the results of the same energy market that operates by a centralized authority. For the simulations, we use the model built by Broeer et al. [176]. This model has been developed to represent a physical demonstration project conducted on the Olympic Peninsula, Washington, USA.

The rest of this section is organized as follows. In the section 8.2 we present the required background and the basic concepts. Next, in section 8.3 we introduce the basic recent studies that apply blockchain technology in the power grids. Our design and implementation efforts for an effective decentralized market are given in section 8.4 while simulation results and their preliminary analysis in section 8.5. Finally, section 8.6 contains the synopsis of our work together with our future research and development plans.

8.2 Background and Concepts

Blockchain is a distributed public ledger in which transactions are recorded chronologically and publicly. These transactions are recorded in blocks, and nodes in a distributed network agree on the next valid block. The algorithm that enables the nodes to reach an agreement on the next block is called consensus algorithm. The very first block in the chain of each blockchain is called genesis block.

Once a valid block is found, it is added to the blockchain, and it is relayed to the network of the nodes. A node is a computer connected to the blockchain network using a client software that performs the task of validating and relaying transactions. Anyone can join a public blockchain network just by running a client on a local computer while a validated invitation is required to join a private or a consortium one. Once the node connects to the network it gets a copy of the entire blockchain. For a detailed description of the blockchain protocol the reader is referred to [45].

There are certain advantages as well as specific disadvantages of using a public or a private blockchain. For our study we consider consortium (permissioned) blockchain networks for the following main reasons.

- Our network of energy producers and consumers will be relatively small compared to the size of most of the public blockchains. As such they more naturally map onto consortium blockchains, they take up less energy and thus power consumption doesn't usually become an issue.
- Due to their nature, consortium blockchains are more secure in the sense that nodes that generate new blocks are predetermined and trusted by the network creators. Also, they may join the network by invitation only.
- Power grids rely on the actions of regulators. Therefore, certain centralization is somehow inherent in such grids. Regulator's role needs to be revised when

blockchain technology is included in the next generation power grid operations but there will always play their centralized role, directly or indirectly, fully or partially. It is widely accepted that consortium blockchain networks do limit, in some sense, decentralization. Nevertheless, this does not consist a disadvantage when considered for power grids since these are commonly operate under the guidance of centralized regulators.

The Linux Foundation's Hyperledger Fabric is an example of a permissioned blockchain framework implementation as well as the Microsoft's Azure framework and several others also are. For our implementation we consider Ethereum consortium blockchains mainly for its current wide acceptance and its large users community.

Recent studies[33] propose that electricity markets, in order to better serve the future needs of the power systems, must properly represent in their models the physical constraints of the system and allow the active participation of the demand side. The basic equations describing the physical constraints are given by Ohm's and Kirchhoff's laws setting the constraints for current and voltage at each node. The electrical power, as the product of voltage and current, introduces one of the nonlinearities that makes power systems difficult to optimize[177]. Today, when operational settings suggested by the solution of the linear approximation of the power flow equations do not match the real-time needs of the grid, operators make adjustments based on their experience and not on an optimal solution. We believe that using the benefits of blockchain technology we can design markets that belong to their participants, are operated by them. These participants using blockchain technology can interact and take decisions towards market and power stability.

In the current study we present a distributed system based on blockchain technology that is intended to serve as a platform for the operation of electricity markets. Such a system has the potential to provide the following main benefits:

- Lower the barriers for small prosumers participation in the market. To join a decentralized market as the one proposed in this work, a prosumer must be provided with a pair of cryptographic keys to join the permissioned P2P blockchain network and maintain a running blockchain node.
- Allow parties that do not trust each other to interact and operate in a common decentralized market that belongs to them, its participants. There is no central authority, with which every market participant interacts.
- Market participants are able to operate according to commonly accepted rules that are translated into code and through smart contracts are shared among them. Smart contracts describe the rules of interaction among the market participants and a copy of each smart contract deployed on the blockchain network exists in every node.
- Monetary settlements and transactions are instantaneous using cryptocurrencies.
- Such a platform can be very modular. The market rules can change by applying a new smart contract and several markets can operate in parallel having different rules and priorities by having multiple smart contracts deployed. This way participants are able to select in which market they will participate according to their priorities like share of green energy or economic benefits.

8.3 Related Studies

There exist a plethora of studies that concentrate in the penetration of the blockchain technologies into the energy sector (see [46], [178] for a recent review). Many of these studies consider energy markets and several of them are related to our efforts. Most of them appeared during the last two to three years. Next we present those that have been selected for their scientific merit, their technological importance and their entrepreneurial potential. Please note that our study is related to all of the following efforts. In particular, it specifically focuses to matters considered in the ones in the areas of the entrepreneurial activities, Peer-to-Peer energy trading and local energy markets.

8.4 Design and Implementation

Currently, there exist several blockchain platforms, some still under development, each one with its own special characteristics. These characteristics need to be properly aligned with the characteristics of the particular application in order to select the most appropriate platform for its implementation. Please note that [179] compares the most popular existing blockchain platforms on the basis of several criteria related to usability, flexibility, performance and potential. It concludes that currently Ethereum [180] is the most suitable platform for building custom applications. Apart from the criteria presented in [179] Ethereum is considered to be mature, context independent and with a relatively large active community. For the realization of our blockchain P2P network we have used Ethereum's blockchain implementation and the smart contracts were written in Solidity[181].

For the needs of our study for power grid simulations we use GridLab-D [55], an energy grid simulation system, that combines power flow equations with financial mechanisms. It is an open source, detailed and comprehensive agent-based system that has been recently developed mainly in C++. It is widely used for research and development purposes and is based on the experience of a large group of researchers and practitioners.

Furthermore, the openness of both the architecture and the code of GridLab-D allowed us in the past to enhance it with several required for our studies capabilities[182]. We continue this enhancement for the specific needs of our present study as described below.

Therefore, the fact that GridLab-D is a modular system allows us to easily add extra functionality to the objects it simulates. More specifically, we have extended the transactive controller object by adding to it a blockchain object. The transactive controller object provides price-responsive appliance control within GridLab-D, while our blockchain object enables the appliances to send transactions to the blockchain network.

We have created a consortium P2P blockchain network, with more than 250 nodes. 40 of these nodes are controlled by generators and the rest by houses. In addition we also run three extra nodes as miners. The three miners are connected as static neighbors, which means that if at some point the connection between them is lost they will try to reconnect immediately. The other nodes find their neighbors using discovery protocol. On a disconnect of a non-static neighbor, the node may replace the disconnected neighbor with an other node close to it. A maximum of four accounts can use each node. Every market participant has access to an externally controlled account using a password and a pair of public and private cryptographic

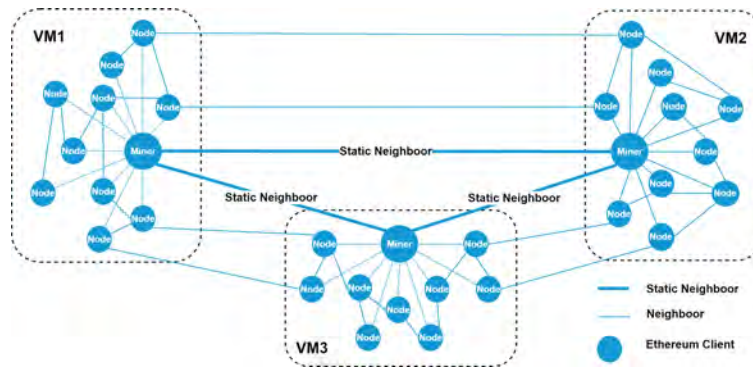

FIGURE 8.3: P2P Blockchain Network

keys. This pair is installed on the blockchain node, to which the participant has access to.

The consensus algorithm that we choose is Proof-of-Authority. It is mainly chosen to fulfill our market step timing requirements, as this is one of the main requirements in energy market applications based on blockchain [110]. The three miners are added as authorized accounts in the genesis block to generate blocks. The miners may be changed during the operation of the network using a voting procedure among the nodes. Proof-of-Authority, clique implementation was used in our simulations, which allows us to define the block generation time in seconds accuracy.

For our system, the electricity market is based on a smart contract deployed on our blockchain network. We have created one contract for every simulation scenario. In these smart contracts we specify the rules under which the market operates. The difference between these contracts is the decentralization level of the operations. In the first approach one account is responsible for calling market clearing, in the second approach this operation is randomly called by a participant specified by the smart contract, while in the last approach the computation of the market clearing is done in a completely decentralized way, away from the smart contract. More details on these approaches are given later in section 8.4.1.

We launch our consortium Ethereum network on our departmental servers. Specifically, the blockchain nodes are installed on 3 virtual machines (VMs), about 90 nodes on each machine, with 244G RAM and 16 CPU cores on each VM. In every VM one of the blockchain nodes runs as a miner. GridLAB-D is installed on a 4th VM, equipped with 4G RAM and 4 CPU cores. The structure of the P2P network is illustrated in figure 8.3.

We have developed a C++ library[183] for the communication between C++ applications and Ethereum nodes. We integrated this library into GridLAB-D[184] and utilize it in order to enable each simulated consumer and producer to use the node to which it has access and send transactions to the smart contracts on the blockchain network using JSON-RPC calls.

The simulations run in real-time mode¹, which means that the simulation clock will be attached to the system clock. In this way we achieve the necessary synchronization between the simulations running on different machines and the synchronization between simulation clock and blockchain timestamps. We ran all simulations for one day, namely the 4th of January 2009 in Seattle, WA.

¹http://gridlab-d.shoutwiki.com/wiki/Realtime_server

In our simulations we use the IEEE 4-node test feeder which offers a simple model for the analysis of all the available three-phase transformer connections. Despite its relatively small size, this test feeder is widely used in distributed energy resources studies among other studies[185].

```

1 contract DoubleAuction {
2   address public market;
3   mapping(int => int) consumptionBids;
4   int[] _consumptionPrices;
5   mapping(int => int) generationBids;
6   int[] _generationPrices;
7   Clearing public clearing;
8
9   struct Clearing {
10    int clearingQuantity;
11    int clearingPrice;
12    int clearingType;
13  }
14
15  function DoubleAuction() public{
16    market = msg.sender;
17  }
18  function consumptionBid(int _quantity, int _price, int _marketId)
19    public{
20    if(consumptionBids[_price]==0){
21      _consumptionPrices.push(_price);
22    }
23    consumptionBids[_price] += _quantity;
24  }
25  function generationBid(int _quantity, int _price, int _marketId)
26    public{
27    if(generationBids[_price]==0){
28      _generationPrices.push(_price);
29    }
30    generationBids[_price] += _quantity;
31  }
32  function marketClearing() public{ ... }
33 }

```

LISTING 8.1: Basic Implementation in Solidity for A1

```

1 contract DoubleAuction {
2   mapping(int => int) consumptionBids;
3   int[] _consumptionPrices;
4   mapping(int => int) generationBids;
5   int[] _generationPrices;
6   Clearing public clearing;
7
8   struct Clearing {
9     int clearingQuantity;
10    int clearingPrice;
11    int clearingType;
12  }
13
14  function DoubleAuction() public{
15    market = msg.sender;
16  }
17  function consumptionBid(int _quantity, int _price, int _marketId)
18    public{
19    if(consumptionBids[_price]==0){
20      _consumptionPrices.push(_price);
21    }
22    consumptionBids[_price] += _quantity;

```

```

22     marketClearing();
23 }
24 function generationBid(int _quantity, int _price, int _marketId)
    public{
25     if(generationBids[_price]==0){
26         _generationPrices.push(_price);
27     }
28     generationBids[_price] += _quantity;
29     marketClearing();
30 }
31 function marketClearing() public{ ... }
32 }

```

LISTING 8.2: Basic Implementation in Solidity for A2

```

1 contract DoubleAuction {
2     function DoubleAuction() public{}
3     function consumptionBid(int _quantity, int _price, int _marketId)
    public{}
4     function generationBid(int _quantity, int _price, int _marketId)
    public{}
5 }

```

LISTING 8.3: Stateless Smart Contract, Solidity Implementation for A3

8.4.1 Market implementation approaches

We design and implement three different approaches for our market implementation based on blockchain. In these approaches we gradually increase decentralization. In the first approach all the computation is done on the blockchain network and a particular account is responsible for calling the market clearing function. In the second approach, we remove the reliance on this account and the function is called randomly by any market participant, while the market clearing is still computed on the blockchain. Finally in the third approach, the blockchain is used only to provide consensus on the transactions send by the market participants, while the market clearing is computed externally to blockchain, based on the transactions sent. By increasing decentralization we decrease the cost in gas needed for computation on the blockchain. On the other hand, we rely more on external implementations of the market clearing mechanism. When market clearing is computed on the smart contract, it is guaranteed that all the nodes run the same code to compute market clearing and the result of this computation is stored on the contract state, on the blockchain state. On the third approach, the input for the computation of the market clearing is guaranteed by the blockchain and we have to trust the implementation of the external computation to provide the correct output, that is the market clearing.

A1: The basic implementation of this approach is given in listing 8.1. The contract deployed contains (1) state variables(lines 2-7), (2) functions collecting bids from consumers and producers(lines 18 and 24) and (3) a market clearing function(line 30) that accepts calls exclusively from a specific account to compute the clearing price based on the submitted bids. The externally-controlled account, known as market account, is stored on a state variable(line 2) and is responsible of calling the method in a predefined frequency. In our experiments the market clearing is called every n' , where n is the auction period in seconds. The result of the market clearing is stored in the clearing variable line 7 in listing 8.1

A2: The basic implementation of this approach is given in listing 8.2. The difference between this approach and A1 is that a specific market account is no longer needed. The execution of market clearing function is triggered by functions collecting bids from consumers and producers (lines 22 and 29). In the implementation of the market clearing function (line 31) some checks are executed first and market clearing is computed only once in every auction period. The gas needed for the computation of clearing is paid by an arbitrary participating prosumer in every market round.

A3: The basic implementation of this approach is given in listing 8.3. We call this smart contract stateless because no state variables are used in this approach. This implementation does not use state variables since the result of the clearing is not stored on the blockchain but it is computed locally based on the double auction uniform price algorithm. In this approach we use only the public address of the deployed contract as reference and no functionality is implemented in the methods, see lines 3 and 4. To realize this approach, we produced a software external to blockchain protocol. This software queries, from the blockchain node, the transactions submitted for the last market clearing and computes the market clearing using the double auction uniform price mechanism. In this approach, A3, the prosumers pay the gas for submitting their bids, while market clearing does not involve any cost in gas as it is computed externally to blockchain.

Figures 8.4 and 8.5 visualized the differences between A1, A2 and A3 approaches in the market node.

In A1 and A2 approach the market node device consists only of the blockchain node, see figure 8.4. The steps involved in the communication between a transactive device and the market node are the following:

- 1 A device queries the blockchain node about the current market price.
- 2 The blockchain node replies back with the current market price. The clearing price has been computed by the smart contract and the result is saved in the contract's state.
- 3 The transactive device, taking into account its current state, user preferences and the current market price, places a bid into the market.

In A3 approach the market node device consists of the software computing the clearing price and the blockchain node, see figure 8.5. The steps involved in the communication between the transactive device and the market node, in A3 approach, are the following:

- 1 A device queries the clearing software about the current market price.

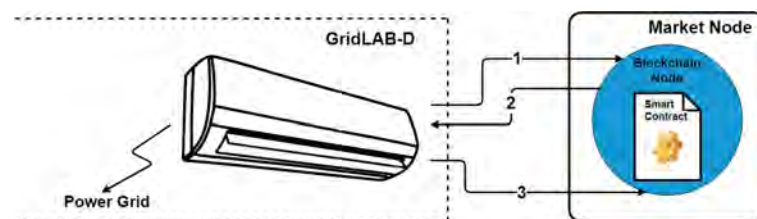

FIGURE 8.4: Communication steps in A1 and A2 approaches

we see that a call to *consumptionBid* function costs 158064 gas. The *Transaction hash*, is generated by signing the transaction data using the private key of the sender. Singing of the transaction ensures that someone else doesn't send this transaction on sender's behalf.

8.5 Simulation Study

8.5.1 Experimental Configuration

We design a collection of experiments in order to investigate the characteristics of our design and implementations and elucidate several related issues. All simulation data are available on-line at [figshare](https://figshare.com)³.

Next we present selected experiments that may be categorized into sets in various ways, such as the number of market participants (varying from 540 to 1000 residential houses), the auction period (varying from 5' to 15') and block generation time (varying from 1', to 5', to 15').

In our experimental setup, appliances, such as HVAC systems and water heaters, are equipped with transactive controllers. These controllers allow them to place price and power demand bids into the market independently and in an automated way [186]. These end-use residential home devices represent the buyers in our market. Electricity suppliers, such as wind and hydro, place price and power supply bids into the market and they represent the sellers. In figure 8.6 we can see the amount of wind power as part of the the total power generation mix.

For the experiments presented in the current work we have used two models considered in [176],

- a basic one which includes 1725kW of wind power and maximum generation capacity of 10MW and a population size of 540 residential houses
- an extended model which includes the same generation capacity and 1000 residential houses.

We first consider a market auction period of 15', which is the case for most of today's European real time energy markets. Then we scale our experiments setting a shorter auction period of 5', which is the case for most of the energy markets in USA today. Alongside we differentiate the block generation time in the blockchain network. The attribute of market participants is also scaled, using the two model mentioned above, increasing the initial number of 540 consumers to 1000. Each of these setups is used to run 3 experiments, one for each different smart contract approach. We present a total of 21 experiments and the detailed setup for these experiments can be found in Table 8.2.

8.5.2 Effectiveness

We run these experiments to evaluate the effectiveness of such a distributed system for the operation of an energy market compared to a centralized system. This evaluation is done by comparing the clearing price and quantity of each market clearing over the time horizon of one day. Figures 8.7a and 8.7c compare the 96 market clearings that occur during a day in an energy market with an auction period of 15', while figures 8.7b and 8.7d compare the 288 clearings that occur if the auction period is set to 5'.

³<https://figshare.com/s/0dc21d4c96bf1981ba48>

TABLE 8.2: Setup and results

Acronym	Simulation Parameters			Difference from Centralized				Average Cost						
	Houses	Market period	Block period	Approach	$\ d\ _2$		$\ d\ _\infty$		Consumers		Producers		Clearing	
					Price	Quantity	Price	Quantity	$Gas \times 10^{-6}$	\$	$Gas \times 10^{-6}$	\$	$Gas \times 10^{-6}$	\$
A1_540_15_15	15	15	15	1	0.21	7.04	1.50	25.85	5.60	11.60	6.09	12.62	1,101.16	2,279.41
A2_540_15_15	15	15	15	2	0.21	7.04	1.50	25.85	7.48	15.50	6.39	13.22	-	-
A3_540_15_15	15	15	15	3	0.21	7.04	1.50	25.85	1.90	3.94	2.15	4.46	-	-
A1_540_15_1	15	1	1	1	0.21	7.04	1.50	25.85	5.60	11.60	6.09	12.61	1,102.90	2,283.00
A2_540_15_1	15	1	1	2	0.21	7.04	1.50	25.85	7.39	15.31	6.88	14.26	-	-
A3_540_15_1	15	1	1	3	0.21	7.04	1.50	25.85	1.90	3.94	2.15	4.46	-	-
A1_540_5_5	5	5	5	1	1.26	104.92	15.40	1751.58	18.16	37.59	18.16	37.60	3,642.37	7,539.72
A2_540_5_5	5	5	5	2	0.24	22.50	3.49	240.46	24.42	50.55	19.07	39.48	-	-
A3_540_5_5	5	5	5	3	0.67	21.57	11.25	366.67	6.13	12.70	6.42	13.29	-	-
A1_540_5_1	5	1	1	1	0.09	0.50	0.72	5.17	18.20	37.69	18.16	37.60	3,657.92	7,571.91
A2_540_5_1	5	1	1	2	0.09	0.50	0.72	5.17	24.45	50.62	20.34	42.10	-	-
A3_540_5_1	5	1	1	3	0.09	0.50	0.72	5.17	6.11	12.65	6.40	13.25	-	-
A1_1000_15_15	15	15	15	1	1.51	23.14	10.70	160	5.70	11.80	6.55	13.56	2,079.50	4,304.58
A2_1000_15_15	15	15	15	2	1.66	23.14	12.29	160	7.65	15.85	6.55	13.56	-	-
A3_1000_15_15	15	15	15	3	2.91	94.73	15.47	808.29	2.00	4.15	2.15	4.46	-	-
A1_1000_5_5	5	5	5	1	25.10	1109.99	263.39	4762.00	17.48	36.18	18.56	38.42	5,578.86	11,548.24
A2_1000_5_5	5	5	5	2	9.47	882.91	101.72	3988.27	22.57	46.73	19.46	40.30	-	-
A3_1000_5_5	5	5	5	3	16.72	551.74	261.97	4688.75	6.12	12.68	6.29	13.03	-	-
A1_1000_5_1	5	1	1	1	0.04	0.89	0.27	4.59	18.21	37.71	19.41	40.19	6,911.46	14,306.73
A2_1000_5_1	5	1	1	2	0.04	0.89	0.27	4.59	24.72	51.17	22.64	46.87	-	-
A3_1000_5_1	5	1	1	3	0.04	0.62	0.27	4.59	6.24	12.93	6.42	13.30	-	-

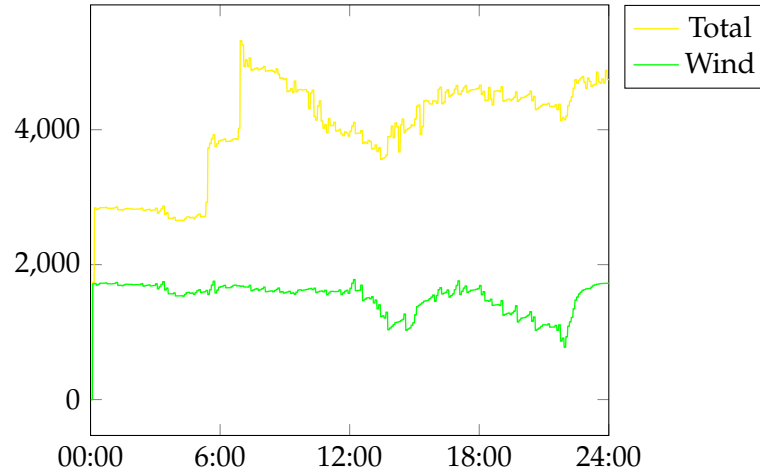

FIGURE 8.6: Generation capacity

We evaluate the results of each experiment, by comparing the outcomes of each clearing in our decentralized system with the respective clearing in the centralized one, which we consider as a basis. We use the scaled L^2 and the L^∞ norms to quantify the differences between both the clearing price and clearing quantity. Specifically, we compute the scaled L^2 norm and L^∞ norm using equations 8.1 and 8.2 respectively.

$$\|\mathbf{d}\|_2 = \sqrt{\frac{1}{n} \sum_{i=1}^n (v_i^c - v_i^d)^2}, \quad i = 1, 2, \dots, n, \quad (8.1)$$

$$\|\mathbf{d}\|_\infty = \max_i (|v_i^c - v_i^d|), \quad i = 1, 2, \dots, n, \quad (8.2)$$

where $\mathbf{d} \in \mathbb{R}^n$ is a vector whose elements hold the differences of the clearings, v_i^c and v_i^d for $i = 1, \dots, n$ with i being the index of each clearing incident and n the total number of clearings that occur during the particular day of the simulation. v_i^c and v_i^d denote either the clearing prices or the clearing quantities at the i th clearing of the centralized and the decentralized models respectively, as indicated by their superscripts.

Please note that $n = 96$ if the market auction period equals 15' or $n = 288$ if the market auction period equals 5'.

The calculated difference norms for all our simulations can be found in columns 6 – 9 in table 8.2.

Also the effectiveness of the systems is presented in figure 8.8, in this figure we selectively present the scaled error for the price results and for the experiments with auction period varying from 5' to 1'. The scaled error is computed according to equation 8.3, where SE_i is the difference between the result of the centralized and the decentralized system for each market clearing, divided by the average value of the centralized results.

$$SE_i = \frac{|x_i^c - x_i^d|}{x^c} \quad (8.3)$$

In figure 8.7 we present the clearing price and quantity results for the 21 experiments during the 24 hour simulation. Comparing the clearing price and quantity of the experiments we want to visualize the effectiveness of the distributed systems we have implemented compared to the corresponding centralized system.

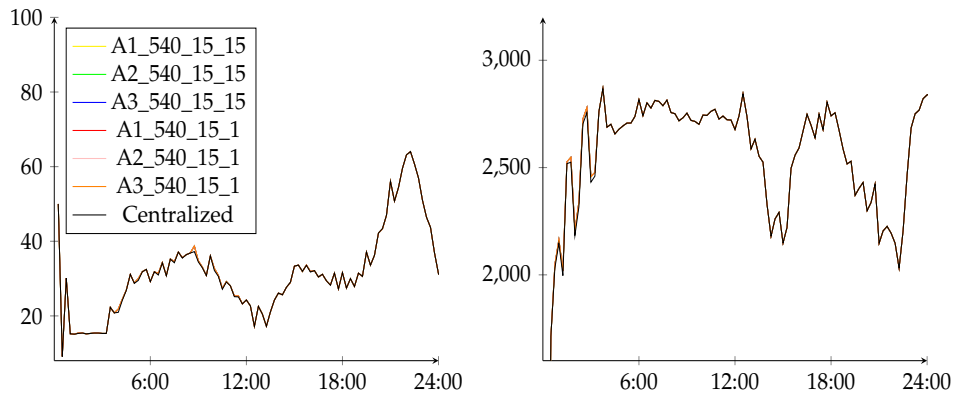

(A) 540 participants, 15' clearing

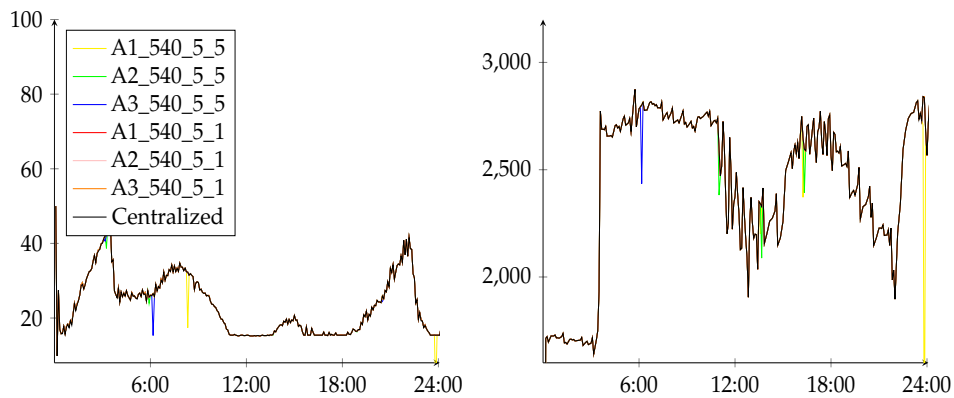

(B) 540 participants, 5' clearing

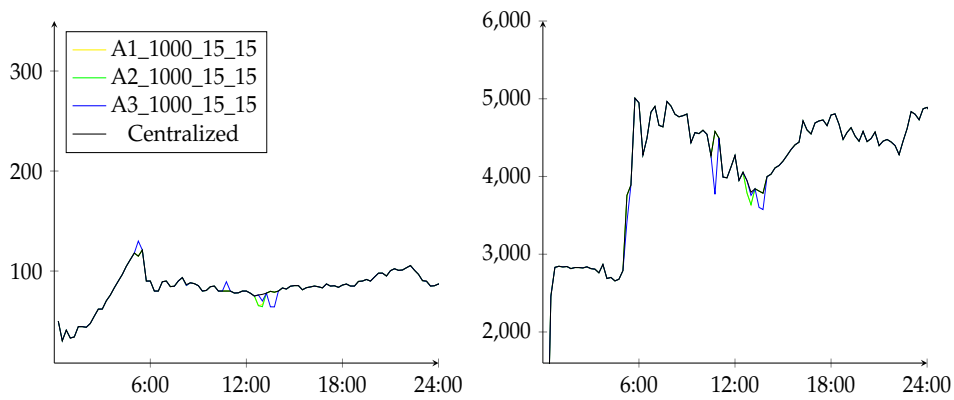

(C) 1000 participants, 15' clearing

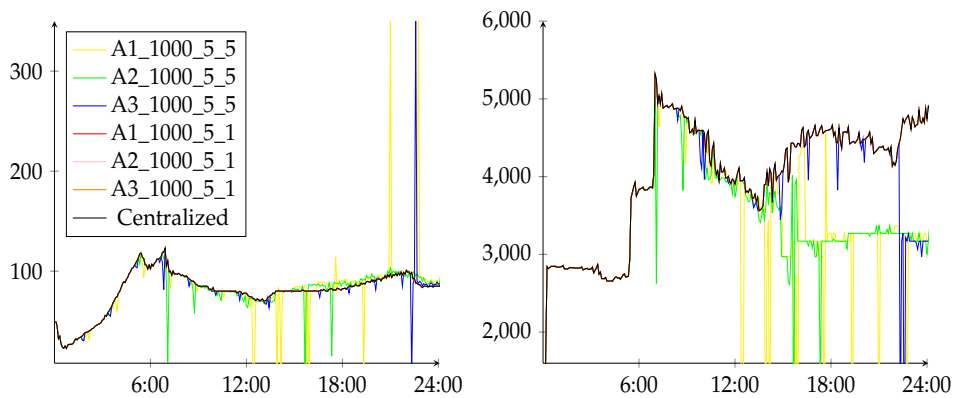

(D) 1000 participants, 5' clearing

FIGURE 8.7: Clearing price(left column) and clearing quantity(right column) results

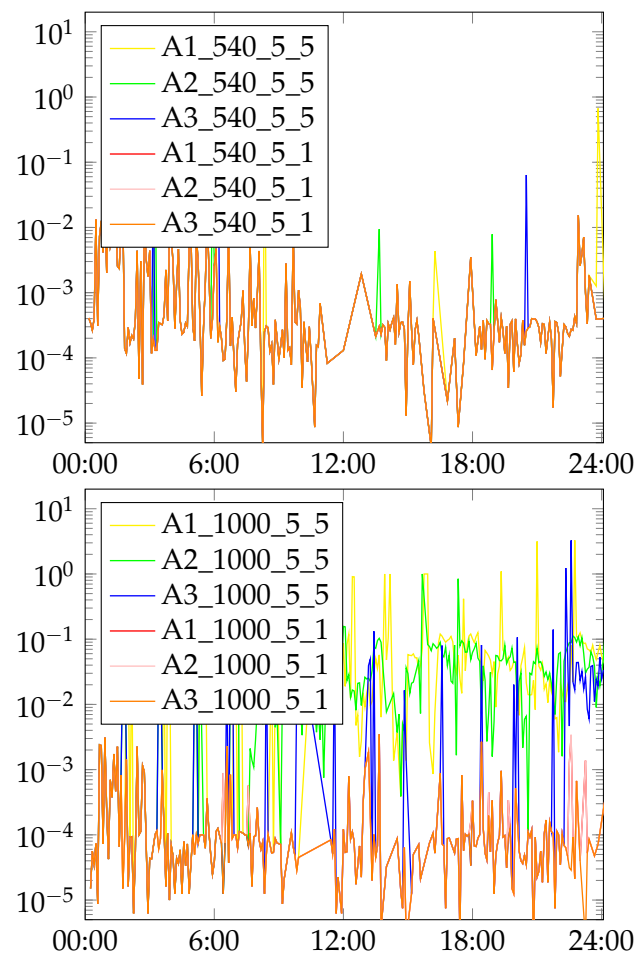

FIGURE 8.8: Clearing price scaled error for 540 (left) and 1000 (right) market participants with a 5' auction period.

In figure 8.7a the results of the first 6 experiments are summarized and compared to the clearing prices and quantities of the centralized system with market auction period 15'. It is clear that the difference between the results of the decentralized systems and the centralized are minor and result in a blurred line on the graphs. The difference of each experiment compared to the centralized system can be seen in Table 8.2. Both the error norms remain unchanged in all of these experiments. This means that the 6 different decentralized systems do not experience any type of overload, either CPU or network and are not affected by any sort of stochasticity.

In figure 8.7b we view the results of the next 6 experiments, where we have reduced the market auction period to 5'. This means that the 540 participants will send one bid every 5' and the computation of the market clearing on the centralized and decentralized systems will occur every 5'. In other words the CPU and network requirement is three times higher compared to the experiments presented in figure 8.7a. The interesting result is that the experiments with the 5' block generation time present some differences compared to the centralized solution. When we reduce the block generation time to 1' these differences disappear. This result comes from the fact that we have created higher computational needs to a system that needs to be synchronized. In the A1_540_5_5, A2_540_5_5 and A3_540_5_5 experiments if a bid that is sent for a specific auction period does not get included in the block that will be generated with the market clearing, it will be added to the next one and will be ignored during the computation of the next clearing. On the other hand in the A1_540_5_1, A2_540_5_1 and A3_540_5_1 experiments bids are added to the blocks that are generated every minute and the market clearing will take into account the bids that were added to the last 5 blocks. Of course, in this case also if a bid gets added to a block after these 5 blocks it will be ignored by the next clearing. In other words if the auction clearing period equals the block generation time, the bids must be included in a specific block in order to be taken into account for the clearing, if the block generation time is 5 time less that the auction period the bids can be included in either of the 5 blocks between two clearings.

The evaluation of these differences can be seen in Table 8.2, the experiments A1_540_5_5, A2_540_5_5 and A3_540_5_5 present an L^2 error norm even a few hundred times higher that the one that is computed for A1_540_5_1, A2_540_5_1 and A3_540_5_1. The maximum error given from L^∞ norm is worse.

These results are also presented in figure 8.8, where the clearing price scaled error for the 6 experiments is depicted. An other interesting observation is that approach 1 has significantly worse results compared to approach 2 and 3. This comes also from the fact that approach 1 has higher synchronization and CPU needs compared to the other two. In approach 1 a blockchain user needs to call the market clearing function when the auction closes. This call is done by a transaction this account sends. If this transaction does not get included to the right block, for any reason, the clearing will never happen.

To confirm our arguments and the assumptions we made in the interpretation of the results of the first 12 experiments, we repeated these experiments by scaling the number of market participants.

In figure 8.7c we see the results of the experiments with 1000 market participants and auction period and block time set equal at 15 minutes. The differences here are minor but visible on the two graphs. Compared to the previous results displayed in figure 8.7a we see that increasing the number of participants causes some stress to the distributed system which is also quantified in Table 8.2 with the error norms.

In figure 8.7d the most interesting results of our experiments are summarized. In figure 8.7d we further stress our system by decreasing the auction period to 5'. In

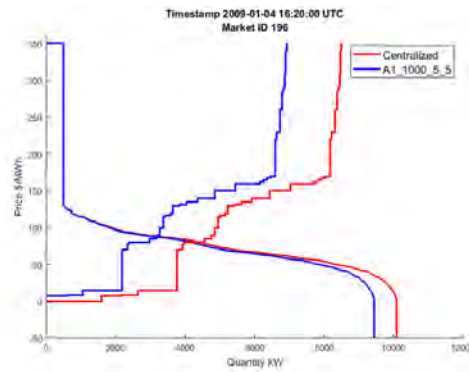

FIGURE 8.9: Uniform Price, Double Auction Market Clearing.

the experiments, where the block generation period was also set to 5', the results are poor. The quality of the results is depicted in figure 8.7d where we see significant differences between the results of the decentralized systems, of all approaches and the results of the centralized system. The quality of the results is also quantified in table 8.2.

In these results we see a great increase in both norms, which means that the difference in the results do not occur in some market clearing but we have a system that is generally overloaded and gets an high error due its whole operation. The error in the experiments A1_1000_5_5, A2_1000_5_5 and A3_1000_5_5 is several times bigger compared to all the other results. Also here, as in the experiments with 540 market participants the results are quite different between the three approaches. Approach 1, which is the most demanding in computation and synchronization, has the worst results. This difference between the three approaches is more visible in the graphical representation of the residual of these approaches in figure 8.8.

By decreasing the block time to 1' the difference between the results of the decentralized systems and the centralized become minor again as in the results presented in figure 8.7b. The quantified error in table 8.2 reaches a minimum and the error presented in figure 8.8 is decreased.

In figure 8.9 we compare the auction clearing that happens at 16:20 of the simulated day in the decentralized system of A1_1000_5_5 experiment and the corresponding centralized. We see that the clearing has moved higher and on the left, which results in higher clearing price and lower clearing quantity. This has happened because a transaction holding a sellers offer and some of the transactions holding buyers offers have not been included at the right block in the blockchain and so they were not taken into account for the clearing. This figure explains the results we see in 8.7d where the clearing price is slightly different in most of the time-slots while the quantity varies considerably.

These results confirm the our arguments in the interpretation of the results of the experiments with 540 participants and verify that a blockchain distributed system designed for an application with high demand on synchronization, such as continuous auctions, need to have a block generation time x times smaller compared to a full application round, as is the auction period in our case study.

8.5.3 Cost

In terms of cost, we have to compare the different approaches between them but also compare the cost of maintaining a consortium blockchain network to deploying the distributed application to a public blockchain network.

In table 8.2 we present the average cost of participating in the market for a consumer and a producer. Also for all the experiments of approach 1 there is an extra cost paid by a specific account for the clearings, this cost in approach 2 is shared among the participants while in approach 3 this cost does not exist because the clearing is not computed on the smart contract but the computation takes place on the local machines running the blockchain client. The differences in costs for the consumers and the producers come from the fact that the number of consumers varies from 540 to 1000 while the number of producers is constant set to 45 in all the setups. If these two numbers were comparable the costs would also be the same.

As it could be predicted, approach 2 is the most expensive between the three approaches in all the setups, this is because of the shared clearing cost and approach 3 is the cheapest. The less gas consuming experiments are A3_540_15_15 and A3_540_15_1, while the most gas consuming experiment is A2_1000_5_1_2. The difference between A2_1000_5_1 and A2_1000_5_5 comes from the fact that in A2_1000_5_5 the network is congested and the clearing function ignores the transactions that arrive late, so the clearing price and quantity are computed taking into account less transactions compared to A2_1000_5_1 that all the network is not congested.

Costs in \$ are calculated using current Ether price (1 Ether = \$230) and the average gas price of 9 Gwei. The cost of each transaction would be paid if the contract was deployed on the public Ethereum network. In the public Ethereum network a transaction has a minimum cost of 21000 gas, this means that if a market participant sends a transaction in every market clearing then the minimum cost per day is 96×21000 if the auction period is 15' or 288×21000 if the auction period is 5', which results in a minimum cost of \$4.17 and \$12.51 respectively. In our experiments consumers sent in average 85 transactions/day in 15' auctions and 269 transactions/day in 5' auctions, on the other hand producers participate in all the auctions. In table 8.2 we can see that approach 3 approaches the minimum cost in all the cases.

8.5.4 Decentralization

Approach 3 is the most decentralized and the one that is closer to the nature of distributed ledger technology. In this approach, the smart contract is used only as a reference public address and in this sense it could be avoided and be replaced by an externally controlled account address or by zero address 0x000.. which is used also for the contract creation.

The deployment in a public network with unpermissioned miners should also be evaluated, as Proof-of-Authority is considered a more centralized approach compared to a public unpermissioned network.

8.5.5 Security

In terms of security, Approach 3 is the most secure since it solely uses blockchain to transfer transactions and not to make computations on it. It is worth to note that most security problems in blockchains arise by manipulations of smart contract execution by malicious users to gain profit[187].

Also in the consortium Proof-of-Authority network, nodes must ensure that the authorized nodes do not get compromised. In the public Proof-of-Work network taking control of the network would need enormous amounts of computational power. In a consortium Proof-of-Authority network the majority of the authorized nodes

has to be compromised in order to take control of the network irrespective of computational power.

8.6 Synopsis and Prospects

We have utilized blockchain to design three uniform price, double auction energy markets and implemented them on a consortium Ethereum network. We comment on qualitative issues and market characteristics like effectiveness, cost, security, privacy and decentralization. We quantitatively compared our three approaches through relatively large and highly realistic scenarios in real time. We also comment on the technical implementation and integration details, in particular those related to the interfacing of the power grid power flow simulation system (GridLAB-D) with the markets and the Ethereum network components. We have seen that a rather small computational cluster is required to fully support all the required computation.

The main conclusion that comes from the interpretation of the results presented in this work is that blockchain distributed systems, designed for an application with high demand on step timing, such as continuous auctions, need to have a block generation time x times smaller compared to a full application round, like the auction period in our case study.

The main problem we faced was the difficulty to track changes in the state of the blockchain as a whole and even harder to track the changes in the state of each contract. Many of these problems arise from the lack of advanced tools for the inspection and the visualization of blockchain networks and individual nodes. Transactions retrieval is time consuming and data retrieved are not directly readable. The above clearly revealed the necessity of powerful tools specifically designed for the development of decentralized applications. Such a debugger is described in [188].

Finally, the creation of a consortium blockchain network, with connected accounts, is a tedious procedure not yet automated, regardless the very recent efforts from AWS⁴ and others.

Our efforts are by no means complete. In fact, they may be considered as just an initial step towards established and practical solutions. In particular the effect of the various perturbations of the classic market mechanisms required for our approaches on the clearing price and quantities should be deeply investigated.

Further indicative future research and development plans include the

- study the effect of competition among energy participants. A way this competition can be expressed in a blockchain application is by the utilization of gas price in the transactions. Producers that are highly competitive may use high gas prices to include their transactions in the next block.
- evaluate the effect different block generation periods have on market competition. Different block generation periods result in different level of information transparency and this affects market competition. Apart from block generation period, a systematic evaluation on the competition on markets that operate over blockchain must be conducted[189].
- study the behavior of our system under stochastic demand and supply[190]

⁴<https://aws.amazon.com/blockchain/templates>

- utilization of other blockchain implementations, including Hyperledger [191] and the evaluation of the different consensus algorithms and membership services.
- extension of the distributed ledger technology to better fit power grid needs[103].
- integration of market outcome with the block generation and validation procedure. Generators that participate in the market and who loss in specific market clearings, instead of wasting their available energy they could use it for mining.

Chapter 9

Blockchain Design and Implementation for Power Grid

9.1 Introduction

In this chapter we study how, through the design of a blockchain consensus algorithm, we can respond to the challenges energy markets face today, as they are described in section 2.2.5.

The work presented in this chapter is the result of a collaboration with **Konstas Mavromatis** during the course of his thesis submitted in University of Thessaly.

We believe that blockchain technology can help in facing some of these challenges, however this is not a straight forward procedure. Chapter 7 presented an extensive review of current academic and entrepreneurial activity at the intersection of power sector and blockchain technology. However, to the best of our knowledge, all existing efforts focus on building applications on existing blockchain implementations. Our study seems to be particularly related to Energy Web Foundation's approach, however this is true only to the goal we both set. Energy Web Foundation (EWF), as stated in its website¹ is a blockchain platform specifically designed for the energy sector's regulatory, operational, and market needs. However, EWF has build a blockchain platform based on Ethereum and using Proof-of-Authority as the consensus algorithm. Our goal is also to build a platform tailored to energy sector's needs, but we believe that this cannot be done using a general purpose blockchain, as Ethereum and using existing consensus algorithms designed not having in mind the shared infrastructure of the power grid. What we do to reach this goal, is design and implement a special purpose blockchain paradigm, that will enable power consumers and producers to reach consensus on their operation taking into account the constraints posed by the underlining power grid infrastructure and topology.

We consider decentralized Energy Markets whose underlining power grid topology consists of generators, consumers, and transmission lines, and which is divided into regions. In the absence of a central System Operator, the Market Location Prices should be computed with coordination between the regions. The local regions perform local Optimal Power Flow (OPF) steps which are subsequently clued together with respect to certain operational constraints using the Alternating Direction Method of Multipliers (ADMM). This problem leads itself to a decentralized coordination problem and the Blockchain Technology seems to be its proper and effective backbone. The regions communicate through a P2P network and blocks are created when an optimal global solution is found.

The main challenge of decentralization is to distribute the Optimal Power Flow (OPF) problem into the regions; autonomous System Operators. With the integration

¹<https://energyweb.org/>

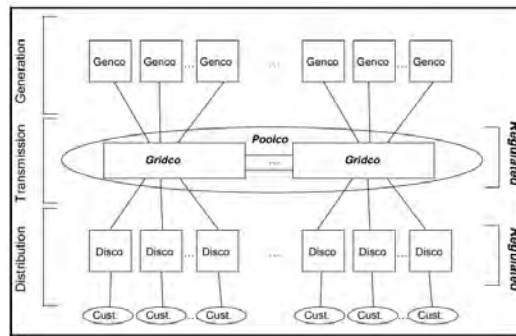

FIGURE 9.1: Wholesale Competitive Market. Source [193]

of the Alternating Direction Method of Multipliers (ADMM), the *fully* decentralization of the system is achieved. The regions solve local OPF problems and communicate with each other in order to find a globally optimal solution - which maximizes the total social welfare.

The computation part of the decentralized algorithm is solved by the ADMM, however proper communication between the regions is a key point. In this chapter, it will be shown how Blockchain technology could be utilized in order to provide a trustful and secure communication. In particular, a private blockchain network is used as the communication backbone, which is suitably modified for the adaption on the ADMM algorithm. Using the Blockchain Technology together with the ADMM algorithm for OPF problems is the chapter's main contribution.

Experiments of this chapter's implementation are provided and analyzed. The quality of the solution is tested, alternating different kind of parameters, and blockchain metrics are also discussed. Additional research opportunities and similar researches are also highlighted.

9.2 Optimal Power Flow and Energy Markets

The traditional power system consists of the physical infrastructure for electricity generation, transport and use on one hand, and an organized electricity market on the other.

The physical grid, that is, the flow of electricity, consists of electricity generators and electricity-transport systems, which are usually subdivided into systems for transmission over long distances and systems for distribution to residential and industrial consumers of electricity.

The electricity market, that is the flow of money, consists of electricity suppliers, consumers, transmission system operators (TSO), distribution system operators (DSO) and regulators[192].

In this chapter's study, **generators** and **consumers** or **loads** will be the key components of the electricity system. As decentralization of the system will be introduced later, various authority-forms of the electricity system will be absent. System Operators will be part of the system but their behavior will drastically change due to the decentralization induced.

In this paper we restrict ourselves to structure of the Electricity Market of Figure 9.1. This competitive wholesale market structure is illustrated that follows this traditional three-part segmentation and promotes open access and competition

It is to be noted that in this work, the transmission and distribution components coincide. This produces more simplicity without affecting the final results of the

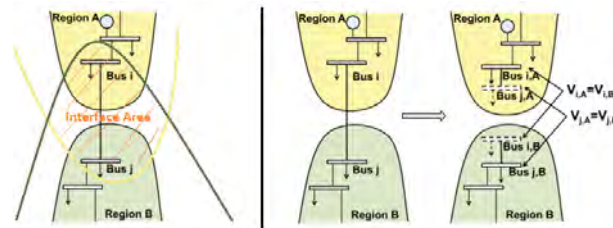

FIGURE 9.2: Duplicating voltages at boundaries of regions.[202]

implemented decentralization. Most cases that are experimented do not dissociate these two components.

9.3 Decentralized Optimal Power Flow

Relying on a centralized System Operation could distort both dispatch and expansion. The introduction of a decentralized approach towards this matter would reinforce trust among participants and the system. Trust suggests lack of individual incentives, making the investment on energy markets more appealing [194]. Furthermore, to facilitate the application of optimal control to large-scale systems, the overall problem may be decomposed into subproblems which are solved in a coordinated way. This also complies with the above mentioned fact, that the task of controlling a system might be shared by several entities (e.g. distinct areas), of which, each one is in charge for a specified part of the system [195].

The ADMM algorithm ([196] [197]) can be applied to OPF problems which are completely distributed/decentralized, i.e., do not require any form of central coordination, and are applicable to any network. The solution is based upon a region-based (local) optimization process, where a limited amount of information is exchanged only between neighboring regions in a (locally) broadcast way [198]. Similar algorithm can be found in [199]–[201] but their disadvantages are that they are not *fully* decentralized or they can assure convergence only under certain conditions.

9.3.1 ADMM in Optimal Power Flow

The OPF Formulation for Distributed ADMM follows the methodology in [202]. This formulation is also implemented in the experiments of the current work. One specification of this formulation is that it does not take into consideration the transmission line constraints. A lot of literature also omits the presence of transmission constraints, making the computation part simpler. Different OPF formulations for distributed ADMM can be found in [102], [197], [198], [203]–[206].

The OPF problem is decomposed into regions. Each region does not have information about the topology/buses/constraints/costs of the other regions, it only needs to interact with its neighbors. A globally optimal solution will be given by the ADMM. In order for that to happen, neighbor regions need to exchange information. Tie lines, i.e connecting transmission lines between two neighbors, are treated like in Figure 9.2 :

Duplicating the voltages on region boundaries results in that the tie lines are removed and the regions are totally separated. Each region's OPF problem consists of the following equations :

minimize $f(P)$ - i.e. the total generators' costs within the region.

subject to : equality and inequality equations as described in Section 2.1.2.

Because of the interface voltages decomposition (Figure 9.2), two more equality constraints are added for region A , which has region B as a neighbor - bus i and bus j are their interface buses respectively (more neighbors would add more voltage equality constraints of the same form) [202]:

$$V_{i,A} - V_{j,A} = V_{i,B} - V_{j,B}$$

$$V_{i,A} + V_{j,A} = V_{i,B} + V_{j,B}$$

We define:

$$z_k = (z_{i,j}^-, z_{i,j}^+) = (\beta^-(V_{i,A} - V_{j,A}), \beta^+(V_{i,A} + V_{j,A}))$$

where β^- and β^+ are scaling factors. Constant β^- is set to be larger than β^+ to give more weight to $V_{i,A} - V_{j,A}$, which is strongly related to the line flow through tie line ij , [207].

and, the feasible region of all the z 's associated with tie lines is defined as

$$Z = \{(z^-, z^+) | z_{i,j}^- = -z_{j,i}^-, z_{i,j}^+ = z_{j,i}^+, \forall (i, j) \in \text{inter-region tie lines}\}$$

And the problem is reformulated using the $x_k = \{(P_i, V_i, Q_i, \theta_i) | \forall \text{ bus } i\}$ variable (the set of control and state variables of k region for every regional bus i - containing the duplicated neighbor ones. We have for each k region (omitting transmission limits) :

$$\text{minimize } f_k(x_k)$$

subject to:

$$A_k x_k = z_k, \quad \text{i.e. the boundary voltages in respect of } x_k$$

$$g(x_k) = 0, \quad \text{i.e. the power flow equality constraints.}$$

$$x_{k_{min}} \leq x_k \leq x_{k_{max}}, \quad \text{i.e. operational limit inequality constraints.}$$

$$z_k \in Z, \quad \text{i.e equalities in boundary voltages between neighbors.}$$

For simplicity, we express the constraints $\{g(x_k) = 0, x_{k_{min}} \leq x_k \leq x_{k_{max}}\}$ as $x_k \in X_k$. Because of the limitation $z_k \in Z$, it is obvious that information needs to be exchanged between neighbor regions, it is the only constraint that does not depend totally on region k . An important property of problem above is that if z is fixed, then the problem can be decomposed into subproblems where each subproblem only contains the local variables x_k . This property enables distributing the computations of ADMM to solve the whole problem.

The ADMM algorithm minimizes the Augmented Lagrangian function ([208], [209]) of the problem, which is given as follows for region k :

$$L_k(x_k, z_k, \lambda_k) = f_k(x_k) + \lambda_k^T (A_k x_k - z_k) + \frac{1}{2} \|A_k x_k - z_k\|_{\rho_k}^2$$

The vector ρ is a vector of penalty parameters whose entries are increased during the iterative process [202] to ensure convergence of ADMM [197]. The $(v+1)$ -th

iteration of the local ADMM consists of the following steps:

$$\begin{aligned} x_k^{v+1} &= \underset{x_k}{\operatorname{argmin}} L_k(x_k, z_k^v, \lambda_k^v) \\ z_k^{v+1} &= \underset{z_k}{\operatorname{argmin}} L_k(x_k^{v+1}, z_k, \lambda_k^v) \\ \lambda_k^{v+1} &= \lambda_k^v + \operatorname{diag}(\rho_k^v)(A_k x_k^{v+1} - z_k^{v+1}) \end{aligned}$$

Notes: The parameter ρ is updated for faster convergence according to [202]. In the problem formulation some other parameters exist also which tuned optimally according to [210], [211]. As a convergence guidance, the regional primal residue $\Gamma_k^{v+1} = \|A_k x_k^{v+1} - z_k^{v+1}\|_\infty$ is used.

To enhance the performance of ADMM on non-convex problems, the penalty parameter ρ is usually updated to make the Augmented Lagrangian function convex near the solution. Specifically, for any region k , ρ_k is updated as follows [207]:

$$\rho_k^{\sim v+1} = \begin{cases} \|\rho_k^v\|_\infty \mathbf{1}, & \text{if } \Gamma_k^{v+1} \leq \gamma \Gamma_k^v \\ \tau \|\rho_k^v\|_\infty \mathbf{1}, & \text{otherwise} \end{cases}$$

with constants $0 < \gamma < 1$ and $\tau > 1$, and with $\mathbf{1}$ denoting the all-ones vector.

$$\rho_{k,i,j}^{v+1} = \max\{\rho_{k,i,j}^{\sim v+1}, \rho_{l,j,i}^{\sim v+1}\}$$

Algorithm 1 Distributed OPF in Region k

1: **Initialize:**

$$x_k^0, z_k^0 = 0, \lambda_k^0 = 0, \rho_k^0 = \rho_0 \mathbf{1}, v = 0$$

2: **while** Not converged **do**

3: $v \leftarrow v + 1$

4: Update x_k by solving the local OPF

$$x_k^v = \underset{x_k \in X_k}{\operatorname{argmin}} f_k(x_k) + \lambda_k^{v-1 T} (A_k x_k - z_k^{v-1}) + \frac{1}{2} \|A_k x_k - z_k^{v-1}\|_{\rho_k^{v-1}}^2$$

5: Prepare messages $m_k^v = A_k x_k^v$

6: Broadcast m_k^v to neighboring regions and receive m_l^v from each neighboring region $l \neq k$

7: Update z_k using

$$z_{i,j}^{-v} = \frac{1}{2} (m_{k,i,j}^{-v} - m_{l,j,i}^{-v})$$

$$z_{i,j}^{+v} = \frac{1}{2} (m_{k,i,j}^{+v} - m_{l,j,i}^{+v})$$

8: Update λ_k using

$$\lambda_k^v = \lambda_k^{v-1} + \operatorname{diag}(\rho_k^{v-1})(A_k x_k^v - z_k^v)$$

9: Calculate the primal residue Γ_k^v for each region k

10: Check convergence

11: Compute $\tilde{\rho}_k^v$

12: Broadcast $\tilde{\rho}_k^v$ to neighboring regions and receive $\tilde{\rho}_l^v$ from each neighboring region $l \neq k$

13: Update ρ_k

14: **end while**

meaning that we select the maximum ρ from $\{\rho_k, \rho_l\}$ for each tie line (i, j) between regions k and l .

A detailed procedure of the distributed ADMM algorithm for region k is illustrated in Algorithm 1.

A general way to check the convergence is to check whether the primal residue $(\Gamma_k, \forall k)$ is smaller than some ϵ . Convergence is declared when both the primal residue and the maximum bus power mismatch (after voltage averaging) fall below ϵ [202], [207].

9.4 Blockchain in decentralized Optimal Power Flow

The main idea of the proposals is that the Blockchain in an Energy Market provides immediate payments among participants and schedules energy trades. However, all these proposals do not consider the Power Flow Problem - i.e. transmission lines are absent in the system.

In this work, the Blockchain Technology will be used to allow market participants to reach a consensus over a solution to the Optimal Power Flow problem. A centralized System Operator is absent from this system. Decentralized System Operators (e.g. regions) will coordinate between them in order to find the optimal locational clearing prices for the system. The purpose is not to concentrate completely on payment and schedule issues, but to propose an alternative use of blockchain, as it will be the backbone of communication between the regions.

A private Ethereum network ([212]) is set for the communication between the regions. An input topology is given in PYPOWER-case format [213], which is divided into regions. Each region sets its own local optimal power flow problem (Section 9.3.1), having information only about the neighboring interface. The solution to each ADMM iteration is obtained by the PYPOWER Interior Point Solver [214]–[216]. After each iteration, neighbor values of the solution are encoded as Ethereum transactions and through RPC-calls to the Ethereum nodes, these transactions are broadcast to the network. Transactions are gathered in blockchain nodes' transaction pool. The neighbor regions update their local problem based on these solutions and continue to a new ADMM iteration. A new block is created containing every transaction exchanged by the regions. Blocks are generated by authorized nodes and the acceptance of the block by the nodes provides the consensus on the solution.

In Figure 9.3a an decentralized Optimal Power flow problem is illustrated. For simplicity, the problem contains 3 regions and a few buses. In Figure 9.3b, the post-actions of each region (here of Region 3) are illustrated. The post-actions express the preparation of the algorithm - i.e. the actions each region needs to do, before executing the ADMM algorithm.

In Figure 9.4 the execution of the ADMM-OPF algorithm is illustrated (for example for Region 3 following the problem in Figure 9.3). The figure presents the steps of the algorithm and which component of the architecture is responsible for each step.

9.5 Experimental Analysis

In the next section, different experiments are presented in order to test the quality, the convergence and other characteristics of the algorithm. Experiments vary on the initial values and the algorithm's parameters.

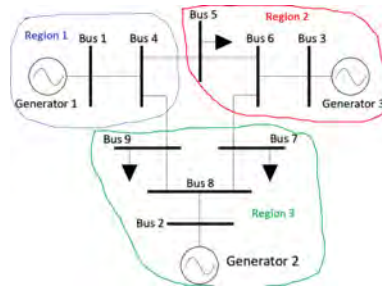

(A) A given Optimal Power Flow Problem.(Adapted from here).

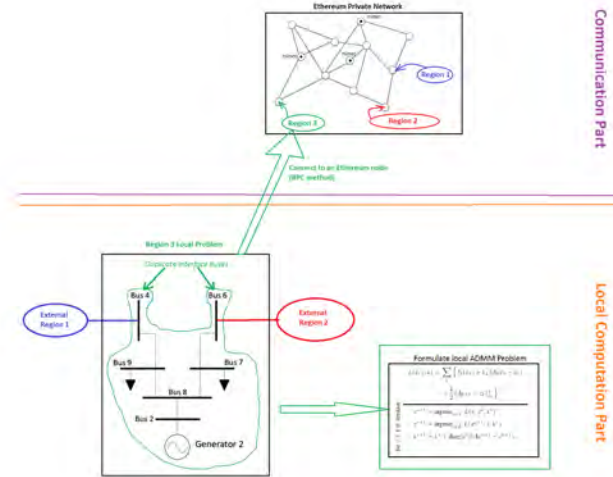

(B) Preparation actions of each region (e.g. Region 3) Schema.

FIGURE 9.3: Preparation of the algorithm per region for a given problem. (Images adaptations from [202], here)

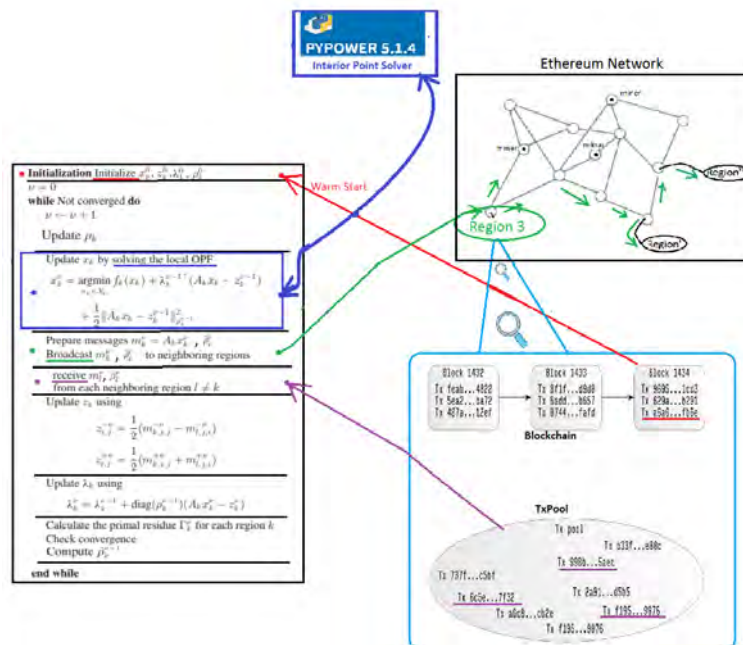

FIGURE 9.4: Algorithm Implementation in the Architecture. (Images adaptations from [202], here)

TABLE 9.1: Metrics on different Cases

Cases	Start	ρ	Convergence Time (secs)	Average Time per iteration (secs)	Objective Function (\$/h)	Gap in Objective Function (%)
30-Bus	Flat	$\rho = 10^4$	45.6	0.023	573	0.66
39-Bus	Flat	$\rho = 10^4$	521.7	0.209	141889	0.06
	Warm	$\rho = 10^4$	32.0	0.022	41880	0.04
57-Bus	Flat	$\rho = 4 * 10^2$	4504.2	5.9	42611	2.09
	Flat	$\rho = 4 * 10^4$	1829.9	2.55	40448	3.08
	Flat	$\rho = 4 * 10^6$	1439.5	2.0	45705	9.50
	Flat	$\rho_{Loads} = 4 * 10^2$ $\rho_{Gens} = 4 * 10^4$	10385.2	13.2	41448	0.69
118-Bus	Flat	$\rho = 10^4$	659.9	0.265	131845	1.68

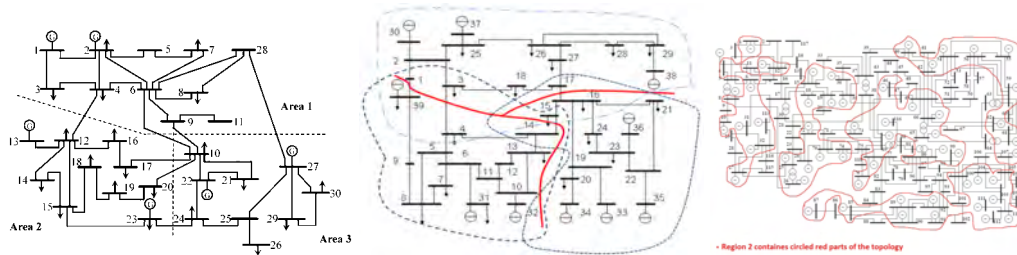

FIGURE 9.5: From left to right: The IEEE 30-Bus Test Case (Source), the 39-Bus Case (Source), the 118-Bus Case (Adapted from here).

9.5.1 Quality and Convergence of Solution

The primal residual for the next cases is selected to be 10^{-3} . Flat Start indicates that the initial values for the ADMM problem are random. On the other hand, Warm Start indicates that values close to the solution are used for initialization.

In this section, we test the 30-Bus, 39-Bus, 57-Bus and 118-Bus IEEE Cases (Figure 9.5). The results are plotted in Figures 9.6, 9.7 and are summarized in Table 9.1.

As it can be seen by the results, the convergence time does not depend totally on the number of buses, but the complexity of the topology (compare the 30-bus with the 39-bus). The biggest deviations appeared on the 30-bus case due to the algorithm's lack of considering transmission line limits. The other cases did not have binding constraints so the Locational Marginal prices were close the optimal solution. When we start the algorithm warmly much less iterations occur, but bigger deviation may appear (here -in 39-bus case- the slack bus deviated the most).

9.5.2 Blockchain - Gas Usage

The nodes in the Ethereum network need to consume *gas* in order to be able to send transactions. The ADMM algorithm demands exchangeable information between the regions, meaning that the nodes in the network who "represent" the corresponding regions need to have the necessary gas resources. For the normal operation of the Ethereum network, every node is supplied with unlimited gas. However, a Gas Usage Analysis is done for a better understanding (Figure 9.8).

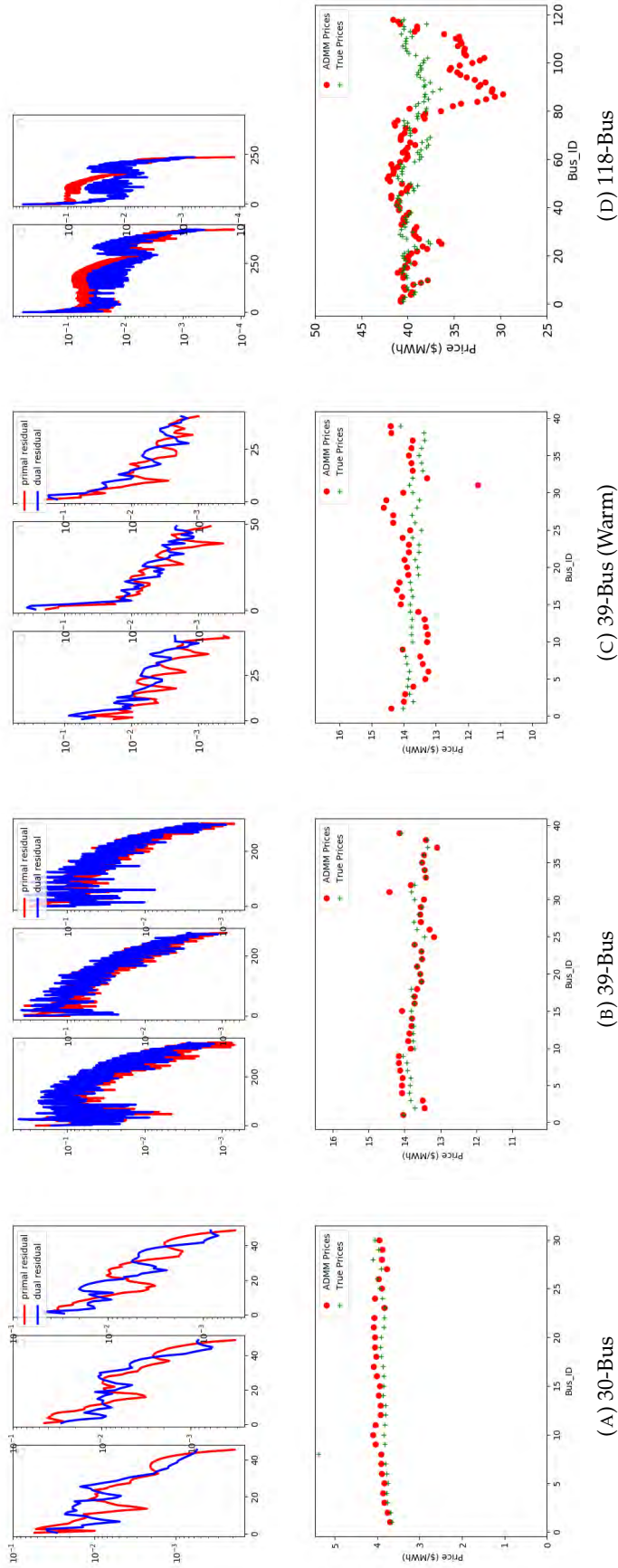

FIGURE 9.6: Iterations until convergence per region (top) and Locational Prices at the Buses (bottom) for the Test Cases.

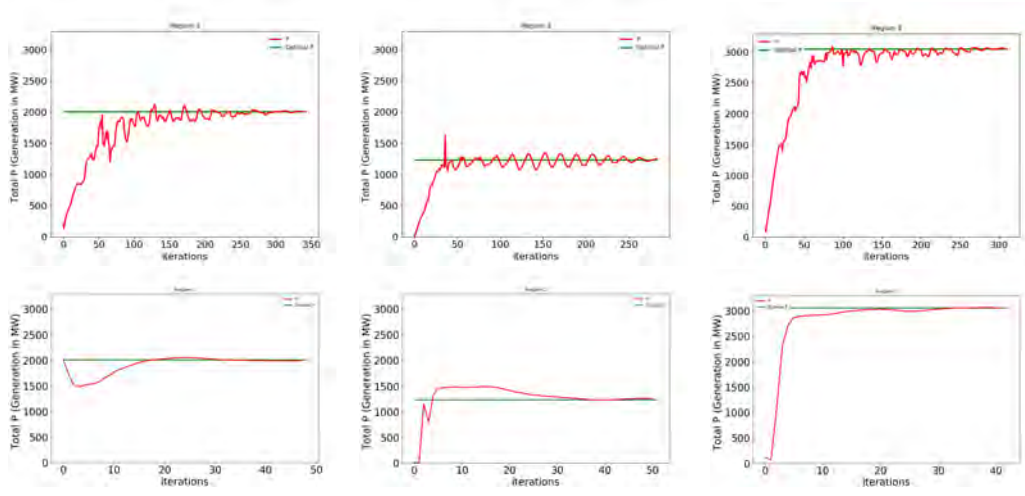
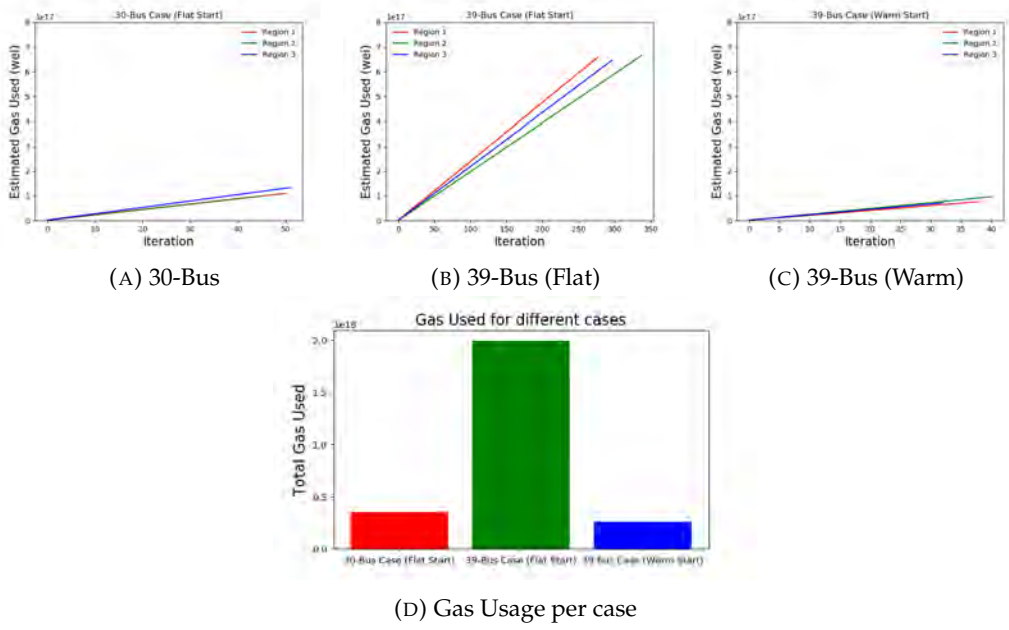

FIGURE 9.7: Active Power Generation between the Decentralized and Centralized solution of the 39-Bus Case: Flat Start on the top plots, Warm Start on the bottom plots .



(A) 30-Bus (B) 39-Bus (Flat) (C) 39-Bus (Warm) (D) Gas Usage per case

FIGURE 9.8: Estimated Gas until Convergence for different Cases.

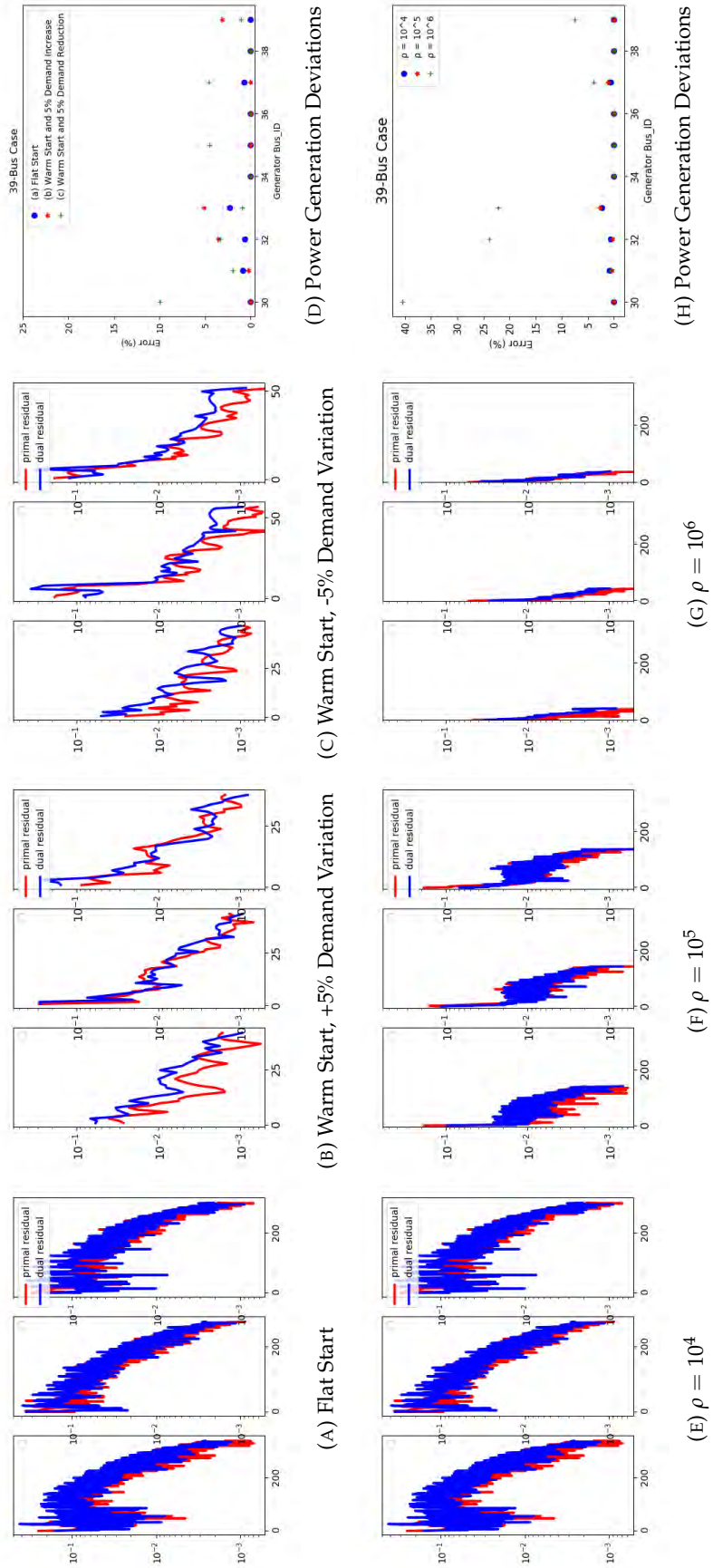

FIGURE 9.9: Convergence in 39-Bus Case

9.5.3 Convergence Robustness

The convergence time and the number iterations are dependent on the initial values and parameters of the ADMM problem. One important parameter is ρ , which accelerates the convergence [207]. If the initial values are far from the solution, a small ρ should be selected. On the other hand, larger ρ needs much less iterations.

The experiments continue with the 39-bus case but the load/demands at the buses will be changed. In a real balanced system, the loads do not change dramatically from time to time, but small input differences are applied. This is the case that is tested in Figures 9.9a-9.9d. It is shown that with small input differences, the algorithm converges fast enough (due to the Warm Start) and the deviations from the centralizes solution remain in acceptable intervals.

In Figures 9.9e- 9.9h different initial selection of ρ are tested for Flat Starts in 39-bus case. The deviation results indicate the one should be careful on the ρ selection: Every case has an optimal ρ that combines the best performance with the smallest deviations.

The blockchain is a huge database. This characteristic can help System Operators to select the suitable initialization values for better convergence robustness. As every block is timestamped, the Operators could select starting points for the topology based on time, period, season, etc.

9.5.4 The special case of 'one Bus per Region'

In order to create a multinodal blockchain network, the 57-Bus IEEE Case was divided into 57 regions-nodes, with one bus per region (Figure 9.10). The case consists of 7 generators. In this experiment, the great impact of ρ 's value was confirmed. In Figure 9.11 we provide the convergence and the deviations of power generation based on initial ρ values. The results are summarized in Table 9.1. With a careful look at the iterations it can be observed that the power generation remains at zero levels before its uptrend - especially for smaller ρ , with generators choosing to minimize their costs by minimizing their production. But as information is broadcast through all buses for the total load demand - which happens through the neighbor values - , ρ is increasing which results into respecting more to the neighbor values mismatches. While generators' motivation was firstly to minimize their cost, this motivation turns into providing the necessary load for their neighbors. However, one should be cautious for the suitable ρ confidence. Extremely high ρ would result into 'super-confidence' for the solution, which deviates more from the optimal solution. It is to be noted that when different ρ was distinguished between loads and

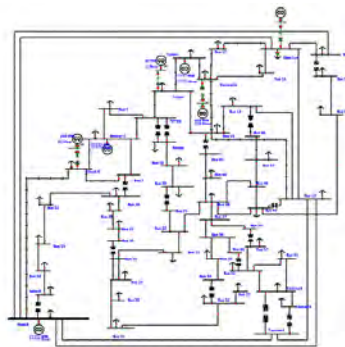

FIGURE 9.10: The IEEE 57-Bus Case (Source)

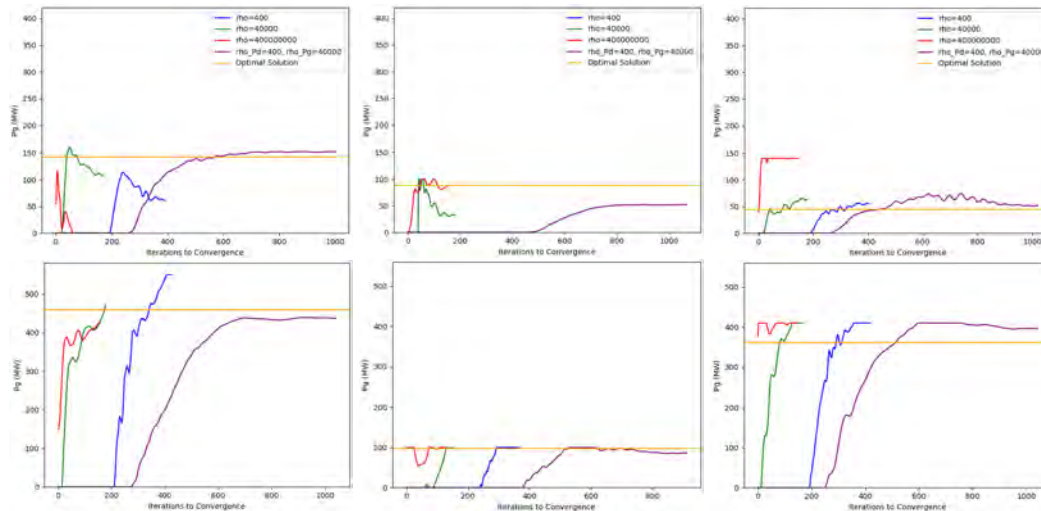

FIGURE 9.11: Results in power generation of the 57-Bus Case

generators, the results were closer to the optimal solution. We evaluated our results based on the individual mismatch of each generator rather than the final objective function gap - respecting more by that way the true LMPs.

One drawback for interpreting the real impact of the ρ selection is that it is used in an objective function which consists of two different parts: Cost minimization measured in \$ and the Augmented Lagrange minimization which is a numerical output. This measurement detail prevents from explaining the real physical nature of the problem.

9.6 Related Work

To the best of our knowledge the only work that combines Energy Markets with Blockchain Technologies, respecting the Power Flow limits, can be found in [102]. This is also an architecture which solves decentralized optimal power flow problem with the ADMM method, using as communication backbone the blockchain technology.

9.6.1 Differences

- Fully decentralized vs Partly decentralized
- No Smart Contract vs Smart Contract

This chapter's implementation guarantees verified results under a *fully* decentralized model. That means that every region needs to know its inner topology, while no information about the topology beyond the region's borders is needed.

On the other hand, in [102] it is assumed that the network topology is fully known by all parties, while authors do not consider changes in line impedances or in topology (e.g. due to temperature changes or due to outages).

Moreover, the presence of a smart contract as an ADMM Aggregator indicates that if a different topology is given as an input, a new smart contract must be created for the new problem. This limitation sets a barrier on the automated operation of the blockchain. Finally, it has to be noted that every computation in a smart contract uses extra gas and depends on the computation's complexity. Unfortunately, gas usage

comparison cannot be done between the two implementations, because it depends strongly on the transactions' nature - and this information is not available.

9.7 Synopsis and Research Plans

An architecture which divides an Economic Dispatch problem into regions, solving OPF problems with the ADMM was designed. The regions were representing nodes in an Ethereum private network. In this network, the information exchange is more than feasible and every Economic Dispatch solution is stored in a blockchain. Experimental analysis indicates satisfying results for this architecture. Similar research and future research are also highlighted.

Future Work will include the following improvements: The first one is the ability of the implementation to consider line transmission constraints and how they affect the Locational Prices and limit the power transmission from cheap generators. The second would integrate automatic real-time payments. The blockchain technology provides naturally this possibility - smart contracts could take care of the billing between the participants, collaborating with smart meters in order to ascertain the actual amount of energy consumed. Fraud detection algorithms could also be developed.

Chapter 10

Inspecting Blockchain Applications

10.1 Introduction

Decentralized applications tend to become common practice. Their development thought requires models, practices and tools that are currently not available. In this study we focus on the software engineering tools that are required for the efficient and effective development of such applications. Specifically, this chapter considers the challenges to develop applications on distributed ledgers and in particular those equipped with smart contract capabilities. It provides a working prototype but fully functional solution, implemented on the Ethereum blockchain, to assist the developer face these challenges.

The work presented in this chapter is the result of a collaboration with **Dimitrios Greasidis** during the course of his master thesis submitted in University of Thessaly.

Due to the wide range of problems that **smart contracts** can solve, more and more developers are implementing systems and applications based on them, and consequently on blockchain. This technology is quite complex in order to function properly and operate in a decentralized way. For this reason, there are many risks during the implementation of a decentralized application (dApp), which have historically led to big losses of money and even the collapse of a company.

The main objective of this work is to identify these risks

- theoretically, through the study of the architecture of the system, and
- practically through the design and the implementation of a tool that assists in the error detection during development and in the inspection of the overall behavior such applications.

The long term goal of our study, is to provide an operational debugging utility which offers mechanisms for elucidating certain behaviors and characteristics of the dApps and the underlying blockchain technologies.

The possible vulnerabilities that may occur during the development of a Dapp, according to literature are summarized in [10.1](#). For more information on these vulnerabilities the reader is referred to [\[217\]](#).

10.2 Related Work

To the best of our knowledge there exist no system or tool that offers the capabilities offered by the Inspector/Analyzer considered in this study. The existing ones focus only on particular aspects, have rather restrictive view-points, limited functionality

TABLE 10.1: Vulnerabilities in a Dapp

Level	Cause of vulnerability
Solidity	Call to the unknown
	Gasless send
	Exception disorders
	Type casts
	Reentrancy
	Keeping secrets
EVM	Immutable bugs
	Ether lost in transfer
	Stack size limit
Blockchain	Unpredictable state
	Generating randomness
	Time constraints

and they commonly suffer from increased requirements and efforts to configure and connect them to the network. In the rest of this section we present the particular aspects that these systems focus to and briefly present the most important ones.

To inspect and analyze a blockchain-based system, we need a tool that allow us to easily connect to any, private or public, blockchain network, in order to explore specific blockchain activities. A basic and common scenario is the case when a user specifies a block of his interest and inspects certain parameters and items in that block; the size of the block, who has mined it, the total gas that this block may contain, the difficulty of the block, the number of the transactions and many more. These parameters may or may not be important depending on the particular application and the nature of the particular blockchain system. Another scenario is to check the transactions that have been mined in a specified block and inspect their arguments.

There already exist several Ethereum network explorers that provide the above described basic functionality. The most important ones are the following:

T1: Ethereum Network Stats (ethstats) [218] ethstats is a well known tool to monitor the activity of the public Ethereum blockchain network. It provides several metrics and offers charts that clearly represent the state of the network. The basic charts offer (almost) real time visualizations for a window of approximately 20 instances. We enumerate and analyze some of them below. It specifically offers (among others) visualization of:

- Block Time chart, which represents the time that was needed to generate each block.
- The difficulty of each block.
- The Uncle Count, which represents the number of the side chains (uncles) for each block.
- The number of transactions per block, which is a good metric to watch the load of the network
- The gas spend for each block.

More metrics are provided such as the gas price, which determines the ether that each transaction costs, the average time that a block is generated and many more.

In ethstats a user cannot explore the blocks or the transactions of the blockchain but can only watch a representation of the network. Also, there is no support for a smart contract or a UI to interact and search specific information that exists in blockchain. This tool is open source and uploaded at GitHub [219]. Nevertheless, the contribute to this project is not an easy task because the documentation is insufficient.

T2: EthExplorer This is one of the first explorers for the Ethereum network[220]. It has a simple UI and provide information on any block and transaction selected by the user.

The basic advantage of this tool is that it is really simple and easy to use but there are also some disadvantages. At first, the tool syncs with the last forty blocks which is a really small number if we consider the size of blockchain. Secondly and most importantly, this tool doesn't provide any scenarios to compare or get a picture of the state of the network. Also, there is no contract support. Lastly, this project is outdated and the last update was nine months ago. Provided that the project is open source it should have a very detailed documentation so that anyone who wants to contribute could start coding easily. Nevertheless, it provides an easy setup and connection with a private network. Thus, the possibility to be used from a developer is high.

T3: Ethereum Block Explorer V2 [221] This project is a fork - replication of the previous explorer with a refreshed UI and some extra features.

This explorer adopts better the sense of an open source project, by providing better documentation, and this is obvious by the usual and relatively large activity of the developers. Even though this explorer is a fork of the previous one, it has a much bigger impact on the open source community, which is obvious from the user reviews it receives. Lastly, the difficulty of the setup and connection to a private network is really low like in EthExplorer.

T4: Etherchain Light [222] Etherchain Light is an Ethereum blockchain explorer built with NodeJS, Express and Parity. It does not require an external database and retrieves all information on the fly from an Ethereum node.

While there are several excellent Ethereum blockchain explorers available (etherscan, ether.camp and etherchain) they operate on a fixed subset of Ethereum networks, usually the mainnet and testnet. Currently there are no network agnostic blockchain explorers available. If you want to develop Dapps on a private testnet or would like to launch a private / consortium network, Etherchain Light will allow you to quickly explore such chains.

Etherchain Light has many advantages compared to its competitors. An important drawback is that it can be only used combined with Parity implementation of Ethereum. It is also not so easy to setup but it uses docker which is an advantage.

T5: ethereum-blockchain-explorer [223] Another much simpler tool is the ethereum blockchain explorer. It has no documentation or instructions and we present it here just for reference. Its similarities with previous explorers are numerous.

Tools that work only with the public network There are a lot of useful tools that work with the public Ethereum network. These tools are usually supported by companies that invest on these products for different reasons. The most famous of them is Etherscan [224]. It is a tool that has the whole Ethereum network saved on a database and provides different useful functions, such as the previous tools, but in a more enterprise way. The basic use of Etherscan is to find all the transactions that are related with an account, through the blockchain and possibly tokens of smart contracts acquired by that account. Very similar with that tool is Etherchain [225] which we will not analyze further. Summarizing, it would be really helpful if there was a tool so much delicate as the ones that exist and work with the Ethereum public network.

T6: QuickBlocks [226] Apart from the software tools described above there is also a number of software libraries, one of the most well known is QuickBlocks.

QuickBlocks is a tool that provides user focused, speed optimized, customizable per smart contract data from any blockchain, including public, consortia and private chains. Through a collection of software libraries, applications, and automatically generated source code, the system improves the quality and accessibility of blockchain data to programmers and end users. Given this improved accessibility, many previously unavailable functionalities, such as fast delivery of smart contract specific JSON data from RPC, detailed gas usage analysis, live debugging and stress testing from previously recorded blockchain interactions, smart contract control panels, and user local, data rich, fully decentralized desktop and mobile applications become possible.

This library is implemented in C++ and has a lot of useful functions which can be used in different simulations on an Ethereum private network.

T7: smart-contract-watch [227] Smart contract watch is a library created to monitor a smart contract. It can monitor smart contracts activity and interactions based on generated transactions and events. For example, it can be used on a local blockchain explorer that runs locally on your server or machine ,or as an investigation tool that scrapes the blockchain in search for a specific query. This is done by sending requests to an Ethereum node via JSON RPC calls. The fastest way to use this tool is by the CLI after installing it from the official repository.[228].

T8: Truffle [229] [230] Truffle is a development environment, testing framework and asset pipeline for Ethereum, aiming to make life as an Ethereum developer easier. With Truffle, you get:

- Built-in smart contract compilation, linking, deployment and binary management.
- Automated contract testing with Mocha and Chai.
- Configurable build pipeline with support for custom build processes.
- Scriptable deployment and migrations framework.
- Network management for deploying to many public & private networks.
- Interactive console for direct contract communication.
- Instant rebuilding of assets during development

- External script runner that executes scripts within a Truffle environment.

Truffle can be used by anyone who wants to practice on Ethereum development and needs a framework so he can better organize his DApp development assets and not have to worry about manually setting up a testing environment.

Summarizing in Table 10.2 we present the features of our Inspector/Analyzer and of the above presented tools in short.

It should be mentioned that a common characteristic of virtually all the above mentioned tools is their incomplete and in certain cases poor documentation and the difficulty in their setup. It is our belief that the developed prototype of the Inspector-Visualizer greatly improves in this direction.

10.3 Design and Implementation of an Inspector/Visualizer

10.3.1 Developing a Dapp

To submit a transaction and interact with the smart contract, there are some requirements to be fulfilled. We will state those requirements briefly below.

- An account should exist which will be the sender of the transaction. If an account doesn't exist the transaction will fail and the desired action will not be accomplished.
- The address of the recipient, in our case the address of the smart contract, must be valid. If not the gas from the transaction will be lost and the action obviously will not be executed.
- The input value, which refers to the money an account wants to send to another, must be lower or equal to the remaining amount.
- The gas parameter, should have higher value from the expected cost of the transaction, which is the most times unknown. A lower gas value will roll back the execution of the code and the gas will be spent, even though the code didn't execute.
- The gasPrice argument should be higher than the current value of the gasPrice in the blockchain network. If it is lower the transaction will be rejected.
- The input data, which refers to the address of the function and the arguments for that function must be valid.

Those are the basic requirements so that a transaction is valid and executed. As mentioned previously there are pretty much a lot vulnerabilities in smart contracts and also in a system that is based on the blockchain. The basic reason of that, is the plethora of the different subsystems you need to use to create your blockchain application.

The basic subsystems that must function correctly are listed below.

- The smart contract.
- The transactions sent from the user interface of the application.
- The fine tuning of the transactions to the current values of the blockchain and to the expected cost of each action.

To accomplish all the previous a more general tool than a debugger is needed, which will help to monitor and detect such malfunctions in a system based on blockchain. We call our prototype implementation **Inspector - Visualizer**.

TABLE 10.2: Features offered by the Inspector-Analyzer (in the first column) and their availability in related tools.

Feature	Tools
Get Specified Block Information	T2, T3, T4, T5, T6
Get Specified Transaction Information	T2, T3, T4, T5, T6
Explore Block and Transactions using links on UI	T2, T3, T4, T5
Get specified range of blocks	
Sync with over 40 blocks	
Table (accounts, # ts, gas spent), table is generated for a specified range of blocks(time)	
Get Transactions through specified range of Blocks	
Chart Block Information, Get value of: Gas limit, Gas Sent, Gas Spent, Block Size, through specified range of blocks	T1
Chart Gas Spent of Account, Get the gas that an account spent in every block through a specified range of blocks	
Chart Balance of Account, Get balance of account in every block through a specified range of blocks	
Chart Transactions Per Block	T1
Chart Time to Mine Block, Get the elapsed time to mine each block through a specified range of blocks	T1
Get Account Detailed Info, Get basic information of an account (total # of ts on the network, balance, ts through specified range of blocks (if specified))	
Get # Peers of Node	
Real Time Monitoring, Basic global variables of network and 4 real time charts: Difficulty per Block, Gas Limit per Block, Number of Transactions per Block, Gas Spend per Block	T1
Find Mined Contracts through a specified range of blocks and get the address to interact with them	
Compile Contract - Get ABI	T8
Call get Functions of Contract	
Support Private Networks	T2, T3, T5, T6, T7
Support Public Networks	T1, T2, T3, T5, T6, T7

10.3.2 Prototype Implementation

The real time information displayed in the homepage are:

- Difficulty. The difficulty of the last block generated
- Gas Limit. The maximum gas a block can contain.
- Gas Used. The gas that is contained at the last block.
- Gas Price. The price of the gas that represents a function to the value of ether.
- The last block number.

The following screen shots illustrate some of the capabilities of the system developed.

Attribute	Value
number	11808
hash	0x580bd4221c1f97ffd007bfa109d3779491fc4b76cbd5e04fc6a5796411feec
parentHash	0x6930c5c785336de636d977673968873c422a16e659de85686ae46294f25ea948
transactions	2
nonce	0x0b274e80c8dbac16
difficulty	4502358
totalDifficulty	26547230884
size	896
gasLimit	9000000000000
gasUsed	55976
timestamp	13:12
sha3Uncles	0x1dcc4de8dec75d7aab85b567b6ccdd41ad312451b948a7413f0a142fd40d49347
transactionsRoot	0xd0013d5e0fa5b18f545873eb6284889ce59e1cd4e34ee18e5c85019633157587
stateRoot	0x8fabebbb461d600b166e6d3cct26acf6be0bf4c305714734875e5be9fe4b76874
miner	0xAD56CEdb7d9ee48B3B93F682A9e2D87F80221768
extraData	0xd583010703846765746885676f312e39856c696e7578
uncles	

Transactions of block

#	Hash of Transaction
0	0x576734baa0532217a1f7a92ec3bd021e1d1ac537c68443188f84c587b070927e
1	0x698705231ee906d12547b42e7a4dd64f8482b688ede49d598fc30d1bb563d7d0

FIGURE 10.1: Block information

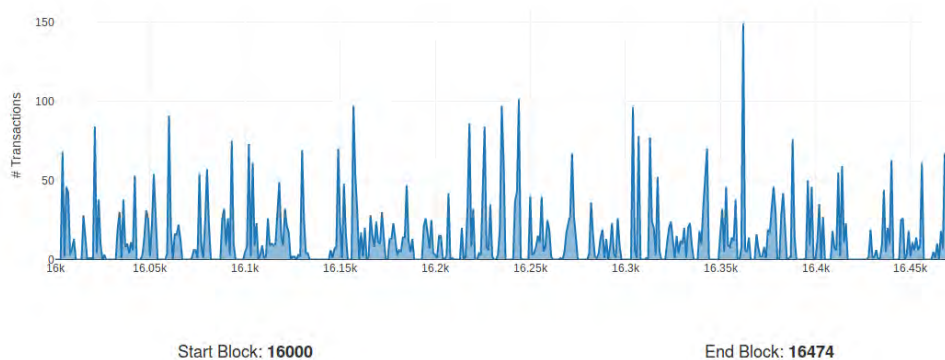

FIGURE 10.2: Number of transactions per block

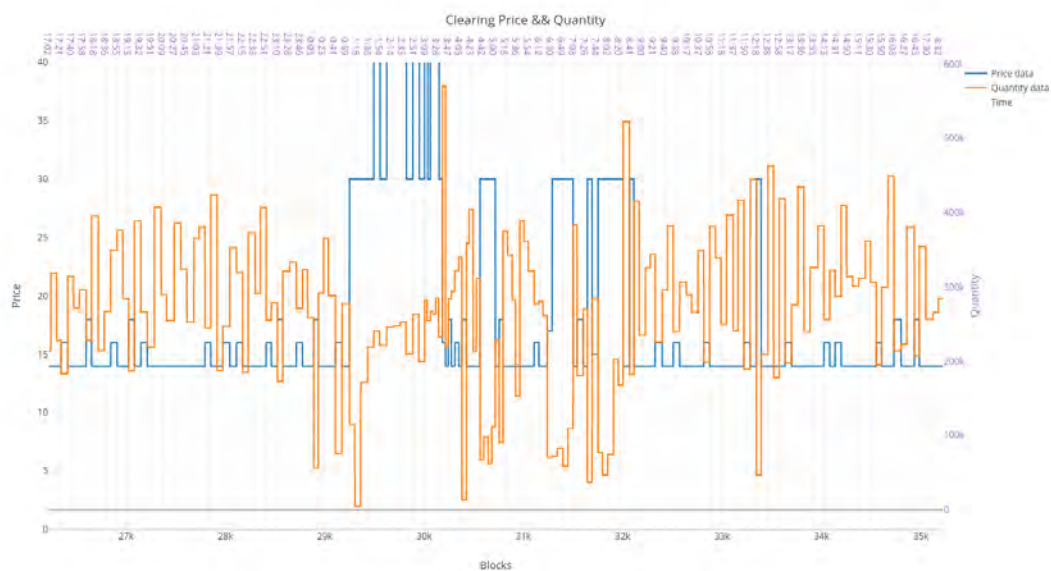

FIGURE 10.6: Contract variables

Part IV

Conclusion

Chapter 11

Synopsis and Future Work

This chapter includes the synopsis of our work and our future plans. Please note that the previous chapters include future prospects, specifically related to the subject of each chapter. In the current section we summarize the work done and enumerate the future prospects that come as a result of this work as a whole.

11.1 Synopsis

In this dissertation we design, implement, analyze and evaluate information models and systems for next generation energy markets, both in centralized and decentralized frameworks. Our main objective is to facilitate the active participation of residential consumers and producers in modern and emerging real-time energy markets under the penetration of renewable energy sources.

Large scale simulations allow us to evaluate our models and study the economic effect they have on the market participants and the stability effect they have both on the power grid and the energy market.

In part II descriptive analytics, predictive analytics and game theoretical algorithms are studied and our findings may be summarized to the following:

- Descriptive data analytics give us insights but their role in a digitized power grid cannot be fundamental but rather complementary. Descriptive analytics could assist people in their decision making but their role in an automated environment is peripheral.
- Prediction models of great accuracy can be built using historical data. The effect they have on the market, the market participants and the power grid varies greatly depending on the way these prediction models are used. In particular we may easily conclude that prediction models without individualism in the learning strategies may affect the market negatively.
- Predictive data analytics combined with game theoretic algorithms provide the individualism missing from the approach presented in chapter 5. The game theoretic algorithms provide social ability to market participants in order to coordinate their operation.

In part III the application of distributed ledger technology on power grids is studied. The conclusions that come from this study include are following:

- Distributed ledger technology has drawn considerable interest from energy supply firms, startups, technology developers and the academic community. The majority of these sources agree that blockchain have the potential to bring significant benefits and innovation to the power sector.

- Blockchain distributed systems, designed for applications with high demand on step timing, such as continuous auctions, need to be carefully designed. For example, the block generation time must be well adjusted to the full application round, like the auction period in our case study. Otherwise, the operation of the market is erratic and very often erroneous.
- Blockchain distributed systems allow market participants to place their bids in energy markets without intermediation, with transparency and affirming that transactions are tamper-proof.
- Distributed optimal power flow algorithms can be utilized as the consensus algorithm in blockchain implementations, extending the capabilities of existing consensus algorithms described in section 2.5.3. This results into a decentralized economic dispatch for the energy market. The proposed approach differentiates itself from the existing solutions of centralized and self dispatch utilized by energy markets today. Therefore, it fits very well within the blockchain general framework.
- There currently exist only primitive tools to assist a blockchain developer. Our study considers the design and development of advanced tools for the inspection and the visualization of blockchain networks, individual nodes and distributed applications' state. This clearly reveals the necessity of powerful tools specifically designed for the development of decentralized applications. Such tools enable us to debug and make decentralized applications more efficient and more secure. Developer friendly tools of this kind, we believe that will result in accelerating the adoption of blockchain technology since, the main vulnerability of blockchain technology comes from distributed applications with unpredictable behavior mainly due to common bugs.

11.2 Future Prospects

The main objective of this work is to pave the way for a systematic research on the exploitation of recent developments in Artificial Intelligence, Embedded Systems and Blockchain Technologies for effective and open markets such as next generation energy markets [231], [232]. We believe that in order to start such research, we need to clarify several issues in the above three thematic areas. This clarification, which is the main objective of our study, is done by learn-by-doing approach.

In particular, this PhD thesis is about exploiting recent developments in deep learning, the Internet of Things and Blockchain to design and develop an prototype system that incorporates the following desirable characteristics:

- Incorporates business logic into devices for participation in open markets without intermediaries, such as for energy consumption and energy generation in a smart grid.
- Provides, through deep learning, intelligence to these devices required for market efficiency and stability.
- Enables market decentralization by designing effective consensus and intelligent algorithms in a private network (e.g. Ethereum and Hyperledger)

Our efforts are by no means complete. Further indicative research and development plans include the following.

Energy markets use information about technical conditions of the grid and information related to bid curves. Currently, European electricity markets are enforcing rules on the disclosure of data concerning physical characteristics, however, the information on bidding curves is often not immediately released. In some markets, bidding data are disclosed immediately after the market clearing, but the bids are aggregated at country level. In other markets, detailed information per production unit is available but only with a delay of several weeks or even months[189].

In decentralized energy markets operating over a P2P network anonymized data are transmitted over this network. These data concerning both the physical grid and the bidding curves are open to all market participants on real time. This means that bidding data are available to all market participants at the time they are submitted.

A systematic evaluation of the competition in energy markets that operate over blockchain would be interesting. We could study how open data, transmitted over the blockchain network, affects the competition among market participants. Also, a reassessment of the potential that the participants have in order to gain economic benefits from analyzing the open data available in decentralized energy markets would be helpful.

We could also quantify the effect decentralized economic dispatch has on the stability of the power grid and the energy market compared to centralized and self dispatch utilized by energy markets today.

Moreover, it is often argued in the literature that blockchain technology could be utilized by energy markets to enable P2P economic transactions among market participants. However, a study of how market incentives change under P2P economic transactions in energy markets is not currently available.

The aspect of user privacy has to be studied also. Existing privacy-enhancing technologies for the smart grid have to be re-evaluated in the context of decentralized operation of the grid and new technologies must be developed to cover the current needs.

Future work on the distributed consensus algorithm presented in our work includes:

- Study how the utilization of data analytics clustering algorithms may enhance the performance of the algorithm. As shown in previous chapters the definition of the regions highly impacts the number of iterations needed until convergence. An initial step, creating the regions, using a clustering algorithm could be evaluated.
- Study methods of solving optimal power flow problem in a distributed way. A systematic comparison of their characteristics must be conducted and understand which one fits best the blockchain consensus process.
- The experimental validation of the decentralized consensus algorithm must be extended by an analysis of the algorithm under attack.

Furthermore, the possibility of integrating economic dispatch of the energy market with transaction validation and block generation procedure of distributed ledger technology could be studied. Generators that participate in the market and who do not succeed in selling their energy in specific market clearings, instead of wasting their available energy they could use it for securing the blockchain.

In this work we restricted ourselves on developing models for the distribution grid. The application of these models in the transmission grid has to be studied.

Bibliography

- [1] M. Foti and M. Vavalis, "Intelligent Bidding in Smart Electricity Markets", *International Journal of Monitoring and Surveillance Technologies Research*, vol. 3, no. 3, pp. 68–90, Jul. 2015, ISSN: 2166-7241. DOI: [10.4018/IJMSTR.2015070104](https://doi.org/10.4018/IJMSTR.2015070104). [Online]. Available: <http://services.igi-global.com/resolvedoi/resolve.aspx?doi=10.4018/IJMSTR.2015070104>.
- [2] M Foti, A Nasiakou, L Vasilaki, and M Vavalis, "On Visualizing Distribution Systems for Next Generation Power Distribution Grids", *International Journal of Computational & Neural Engineering*, pp. 16–27, Jun. 2016. DOI: [10.19070/2572-7389-160004](https://doi.org/10.19070/2572-7389-160004). [Online]. Available: <https://scidoc.org/articlepdfs/IJCNE/IJCNE-2572-7389-03-101.pdf>.
- [3] M. Foti and M. Vavalis, "A learning approach for strategic consumers in smart electricity markets", in *2015 6th International Conference on Information, Intelligence, Systems and Applications (IISA)*, IEEE, Jul. 2015, pp. 1–6, ISBN: 978-1-4673-9311-9. DOI: [10.1109/IISA.2015.7388043](https://doi.org/10.1109/IISA.2015.7388043). [Online]. Available: <http://ieeexplore.ieee.org/lpdocs/epic03/wrapper.htm?arnumber=7388043>.
- [4] N. Akram, S. De Silva, M. Foti, M. Jayasinghe, M. Dayarathna, M. Vavalis, and S. Perera, "Real time data analytics platform for power grid smart applications", in *2017 14th International Conference on the European Energy Market (EEM)*, IEEE, Jun. 2017, pp. 1–6, ISBN: 978-1-5090-5499-2. DOI: [10.1109/EEM.2017.7982012](https://doi.org/10.1109/EEM.2017.7982012). [Online]. Available: <http://ieeexplore.ieee.org/document/7982012/>.
- [5] M. Foti, D. Greasidis, and M. Vavalis, "Viability Analysis of a Decentralized Energy Market Based on Blockchain", in *2018 15th International Conference on the European Energy Market (EEM)*, IEEE, Jun. 2018, pp. 1–5, ISBN: 978-1-5386-1488-4. DOI: [10.1109/EEM.2018.8469906](https://doi.org/10.1109/EEM.2018.8469906). [Online]. Available: <https://ieeexplore.ieee.org/document/8469906/>.
- [6] —, "Blockchain Based Uniform Price Double Auctions for Energy Markets", *to be submitted to IEEE on Smart Grids*, 2018. [Online]. Available: <https://doi.org/10.6084/m9.figshare.6840614.v2>.
- [7] M. Foti, K Mavromatis, and M. Vavalis, "Blockchain Design and Implementation for Decentralized Optimal Power Flow", *to be submitted to Applied Energy*, 2018. [Online]. Available: <https://doi.org/10.6084/m9.figshare.7093835.v2>.
- [8] M. Foti and M. Vavalis, "What blockchain can do for power grids?", *to be submitted to Renewable and Sustainable Energy Reviews*, 2018. [Online]. Available: <https://figshare.com/s/6dbdf69c0f7289077281>.
- [9] C. Antonopoulos, M. Foti, D. Greasidis, and M. Vavalis, "Inspecting and Analyzing Blockchain Applications", *to be submitted to Empirical Software Engineering*, 2018. [Online]. Available: <https://figshare.com/s/925eb7a859a21e28da7d>.

- [10] O. Meikopoulos, M. Vavalis, and M. Foti, "Towards a remedial and rehabilitation e-tourism system", in *Proceedings of the IADIS International Conference on WWW/Internet*, 2015, p. 151.
- [11] M Foti, E Papa, and M Vavalis, "Monitoring an Institution's Research Activities", *International Journal of Information and Education Technology*, vol. 7, no. 5, p. 350, 2017.
- [12] E. Z. Tragos, M. Foti, M. Surligas, G. Lambropoulos, S. Pournaras, S. Papadakis, and V. Angelakis, "An IoT based intelligent building management system for ambient assisted living", in *2015 IEEE International Conference on Communication Workshop (ICCW)*, IEEE, Jun. 2015, pp. 246–252, ISBN: 978-1-4673-6305-1. DOI: 10.1109/ICCW.2015.7247186. [Online]. Available: <http://ieeexplore.ieee.org/document/7247186/>.
- [13] S. Kyriazakos, G. Labropoulos, N. Zonidis, M. Foti, and A. Mihovska, "Applications of Machine Learning and Service Oriented Architectures for the New Era of Smart Living", *Journal of Communication, Navigation, Sensing and Services*, vol. 1, pp. 181–196, 2014. DOI: 10.13052/jconasense2246-2120.124. [Online]. Available: https://www.riverpublishers.com/journal/journal_articles/RP_Journal_2246-2120_124.pdf.
- [14] S. Kyriazakos, G. Labropoulos, N. Zonidis, and M. Foti, "Novel building management system based on machine learning and a cloud-based SOA for Ambient Living", in *2014 4th International Conference on Wireless Communications, Vehicular Technology, Information Theory and Aerospace & Electronic Systems (VITAE)*, IEEE, May 2014, pp. 1–5, ISBN: 978-1-4799-4624-2. DOI: 10.1109/VITAE.2014.6934483. [Online]. Available: <http://ieeexplore.ieee.org/document/6934483/>.
- [15] P. J. Pearson, "Past and prospective energy transitions: Insights from history", *Energy Policy*, vol. 50, pp. 1–7, Nov. 2012, ISSN: 0301-4215. DOI: 10.1016/J.ENPOL.2012.08.014. [Online]. Available: <https://www.sciencedirect.com/science/article/pii/S0301421512006805>.
- [16] M. Höök, J. Li, K. Johansson, and S. Snowden, "Growth Rates of Global Energy Systems and Future Outlooks", *Natural Resources Research*, vol. 21, no. 1, pp. 23–41, Mar. 2012, ISSN: 1520-7439. DOI: 10.1007/s11053-011-9162-0. [Online]. Available: <http://link.springer.com/10.1007/s11053-011-9162-0>.
- [17] R. Fouquet, Fouquet, and Roger, "A Brief History of Energy", 2009. [Online]. Available: https://econpapers.repec.org/bookchap/elgeechap/12764_5f1.htm.
- [18] R. C. Allen, "Backward into the future: The shift to coal and implications for the next energy transition", *Energy Policy*, vol. 50, pp. 17–23, Nov. 2012, ISSN: 0301-4215. DOI: 10.1016/J.ENPOL.2012.03.020. [Online]. Available: <https://www.sciencedirect.com/science/article/pii/S030142151200225X?via%3Dihub>.
- [19] World Resources Institute, *Understanding the IPCC Reports*. [Online]. Available: <https://www.wri.org/ipcc-infographics>.
- [20] "Global Energy Transformation: A Roadmap to 2050", */publications/2018/Apr/Global-Energy-Transition-A-Roadmap-to-2050*, [Online]. Available: <http://www.irena.org/publications/2018/Apr/Global-Energy-Transition-A-Roadmap-to-2050>.

- [21] P. Denholm, M. O'Connell, G. Brinkman, and J. Jorgenson, "Overgeneration from Solar Energy in California. A Field Guide to the Duck Chart", National Renewable Energy Laboratory (NREL), Golden, CO (United States), Tech. Rep., Nov. 2015. DOI: 10.2172/1226167. [Online]. Available: <http://www.osti.gov/servlets/purl/1226167/>.
- [22] T. Ringlever, *Synchronization in power-grid networks*, 2015. [Online]. Available: <https://repository.tudelft.nl/islandora/object/uuid:99a9fdaf-8bb3-445b-ac25-8b4711ac9366>.
- [23] T. Nishikawa and A. E. Motter, "Comparative analysis of existing models for power-grid synchronization", Jan. 2015. DOI: 10.1088/1367-2630/17/1/015012. [Online]. Available: <http://arxiv.org/abs/1501.06926http://dx.doi.org/10.1088/1367-2630/17/1/015012>.
- [24] H. Glavitsch and R. Bacher, "Optimal power flow algorithms", *Analysis and control system techniques for electric power systems*, vol. 41, 1991. [Online]. Available: <https://pdfs.semanticscholar.org/3f4f/d0fb3f8a58e7e68e18e5d45e11152050c35c.pdf>.
- [25] J. Momoh, "A generalized quadratic-based model for optimal power flow", in *Conference Proceedings., IEEE International Conference on Systems, Man and Cybernetics*, IEEE, pp. 261–271. DOI: 10.1109/ICSMC.1989.71294. [Online]. Available: <http://ieeexplore.ieee.org/document/71294/>.
- [26] S. Frank and S. Rebennack, "An introduction to optimal power flow: Theory, formulation, and examples", *IIE Transactions*, vol. 48, no. 12, pp. 1172–1197, Dec. 2016, ISSN: 0740-817X. DOI: 10.1080/0740817X.2016.1189626. [Online]. Available: <https://www.tandfonline.com/doi/full/10.1080/0740817X.2016.1189626>.
- [27] R. Raineri, W. Pfaffenberger, and R. Raineri, "Chile: Where It All Started", in *Electricity Market Reform*, Elsevier, 2006, pp. 77–108, ISBN: 9780080450308. DOI: 10.1016/B978-008045030-8/50005-9.
- [28] F. C. Schweppe, M. C. Caramanis, R. D. Tabors, and R. E. Bohn, *Spot Pricing of Electricity*. Springer US, 1988, p. 384, ISBN: 9781461289500.
- [29] W. W. Hogan, "Contract networks for electric power transmission", *Journal of Regulatory Economics*, vol. 4, no. 3, pp. 211–242, Sep. 1992, ISSN: 0922-680X. DOI: 10.1007/BF00133621. [Online]. Available: <http://link.springer.com/10.1007/BF00133621>.
- [30] W. Hogan, "In My View Best Electricity Market Design Practices", *IEEE Power & Energy*, 2019. [Online]. Available: [https://sites.hks.harvard.edu/fs/whogan/7_Best_Practices%20\(Hogan\)_RCH_03_10_18MIH_rev_final_072518.pdf](https://sites.hks.harvard.edu/fs/whogan/7_Best_Practices%20(Hogan)_RCH_03_10_18MIH_rev_final_072518.pdf).
- [31] S. S. Oren and A. M. Ross, "Can we prevent the gaming of ramp constraints?", *Decision Support Systems*, vol. 40, no. 3-4, pp. 461–471, Oct. 2005, ISSN: 01679236. DOI: 10.1016/j.dss.2004.05.008. [Online]. Available: <http://linkinghub.elsevier.com/retrieve/pii/S0167923604001216>.
- [32] KU LEUVEN ENERGY INSTITUTE, "The current electricity market design in Europe", *EI-FACT SHEET 2015-01*, 2015. [Online]. Available: https://set.kuleuven.be/ei/images/EI_factsheet8_eng.pdf.

- [33] A. J. Conejo and R. Sioshansi, "Rethinking restructured electricity market design: Lessons learned and future needs", *International Journal of Electrical Power & Energy Systems*, vol. 98, pp. 520–530, Jun. 2018, ISSN: 0142-0615. DOI: 10.1016/j.ijepes.2017.12.014. [Online]. Available: <https://www.sciencedirect.com/science/article/pii/S0142061517332246>.
- [34] M. Hogan, "Follow the missing money: Ensuring reliability at least cost to consumers in the transition to a low-carbon power system", *The Electricity Journal*, vol. 30, no. 1, pp. 55–61, Jan. 2017, ISSN: 10406190. DOI: 10.1016/j.tej.2016.12.006. [Online]. Available: <https://linkinghub.elsevier.com/retrieve/pii/S1040619016302512>.
- [35] A. B. Lovins, "Saving gigabucks with negawatts", *Public Util. Fortn.:(United States)*, vol. 115, no. 6, 1985. [Online]. Available: <https://www.osti.gov/biblio/5787710>.
- [36] W. W. Hogan, "Demand Response Compensation, Net Benefits and Cost Allocation: Preliminary Comments", Tech. Rep., 2010. [Online]. Available: www.whogan.com.
- [37] J. D. Kelleher, B. Mac Namee, and A. D'Arcy, *Fundamentals of machine learning for predictive data analytics : algorithms, worked examples, and case studies*, p. 595, ISBN: 9780262029445. [Online]. Available: <https://mitpress.mit.edu/books/fundamentals-machine-learning-predictive-data-analytics>.
- [38] F. Ansari, S. Erol, and W. Sihn, "Rethinking Human-Machine Learning in Industry 4.0: How Does the Paradigm Shift Treat the Role of Human Learning?", *Procedia Manufacturing*, vol. 23, pp. 117–122, Jan. 2018, ISSN: 2351-9789. DOI: 10.1016/j.promfg.2018.04.003. [Online]. Available: <https://www.sciencedirect.com/science/article/pii/S235197891830475X?via%3Dihub>.
- [39] J. Furnkranz, D. Gamberger, and N. Lavrac, *Foundations of rule learning*. Springer, 2012, ISBN: 9783540751977.
- [40] D. Fudenberg and J. Tirole, *Game theory*. MIT Press, 1991, p. 579, ISBN: 9780262061414. [Online]. Available: <https://mitpress.mit.edu/books/game-theory>.
- [41] "Distributed ledger technology: Blackett review - GOV.UK", UK Government Office for Science, Tech. Rep., 2016. [Online]. Available: <https://www.gov.uk/government/publications/distributed-ledger-technology-blackett-review>.
- [42] S. Haber and W. Stornetta, "How to time-stamp a digital document", *Journal of Cryptology*, vol. 3, no. 2, pp. 99–111, 1991, ISSN: 0933-2790. DOI: 10.1007/BF00196791. [Online]. Available: <http://link.springer.com/10.1007/BF00196791>.
- [43] A. Narayanan, J. Bonneau, E. Felten, A. Miller, and S. Goldfeder, *Bitcoin and cryptocurrency technologies : a comprehensive introduction*. Princeton: Princeton University Press, 2016, p. 304, ISBN: 0691171696.
- [44] D. Bayer, S. Haber, and W. S. Stornetta, "Improving the Efficiency and Reliability of Digital Time-Stamping", in *Sequences II*, New York, NY: Springer New York, 1993, pp. 329–334. DOI: 10.1007/978-1-4613-9323-8_{_}24. [Online]. Available: http://link.springer.com/10.1007/978-1-4613-9323-8_24.

- [45] S. Nakamoto, "Bitcoin: A Peer-to-Peer Electronic Cash System", 2008.
- [46] M. Andoni, V. Robu, D. Flynn, S. Abram, D. Geach, D. Jenkins, P. McCallum, and A. Peacock, "Blockchain technology in the energy sector: A systematic review of challenges and opportunities", *Renewable and Sustainable Energy Reviews*, vol. 100, pp. 143–174, Feb. 2019, ISSN: 1364-0321. DOI: 10.1016/J.RSER.2018.10.014. [Online]. Available: <https://www.sciencedirect.com/science/article/pii/S1364032118307184?via%3Dihub#bib60>.
- [47] A. Baliga, "Understanding Blockchain Consensus Models", Tech. Rep., 2017. [Online]. Available: <https://pdfs.semanticscholar.org/da8a/37b10bc1521a4d3de925d7ebc44bb606d740.pdf>.
- [48] *Proof of Stake FAQ*. [Online]. Available: <https://github.com/ethereum/wiki/wiki/Proof-of-Stake-FAQ>.
- [49] A. Bahga and V. Madiseti, *Blockchain Applications: A Hands-On Approach*. VPT, 2017, ISBN: 0996025561, 9780996025560. [Online]. Available: <https://dl.acm.org/citation.cfm?id=3092571>.
- [50] L. Lamport, R. Shostak, and M. Pease, "The Byzantine Generals Problem", *ACM Transactions on Programming Languages and Systems*, vol. 4, no. 3, pp. 382–401, Jul. 1982, ISSN: 01640925. DOI: 10.1145/357172.357176. [Online]. Available: <http://portal.acm.org/citation.cfm?doid=357172.357176>.
- [51] M. Castro, M. Castro, B. Liskov, and B. Liskov, "Practical Byzantine fault tolerance", *OSDI '99: Proceedings of the third symposium on Operating systems design and implementation*, no. February, pp. 173–186, 1999, ISSN: 07342071. DOI: 10.1.1.17.7523. [Online]. Available: <https://www.mendeley.com/research-papers/practical-byzantine-fault-tolerance/>.
- [52] D. P. Chassin, J. C. Fuller, and N. Djilali, "GridLAB-D: An Agent-Based Simulation Framework for Smart Grids", *Journal of Applied Mathematics*, vol. 2014, pp. 1–12, Jun. 2014, ISSN: 1110-757X. DOI: 10.1155/2014/492320. [Online]. Available: <http://www.hindawi.com/journals/jam/2014/492320/>.
- [53] P. Siriwardena, *Enterprise Integration with WSO2 ESB*. Packt Publishing, 2013.
- [54] WSO2 DAS, <http://wso2.com/smart-analytics>, [Online; accessed 28-February-2017].
- [55] D. P. Chassin, J. C. Fuller, and N. Djilali, "GridLAB-D: An Agent-Based Simulation Framework for Smart Grids", *Journal of Applied Mathematics*, vol. 2014, pp. 1–12, May 2014, ISSN: 1110-757X.
- [56] WSO2 CEP, <http://wso2.com/products/complex-event-processor/>, [Online; accessed 28-February-2017].
- [57] R. Fainti, A. Nasiakou, E. Tsoukalas, and M. Vavalis, "Design and Early Simulations of Next Generation Intelligent Energy Systems", *Int. J. Monit. Surveill. Technol. Res.*, vol. 2, no. 2, pp. 58–82, Apr. 2014, ISSN: 2166-7241. DOI: 10.4018/ijmstr.2014040104. [Online]. Available: <http://dx.doi.org/10.4018/ijmstr.2014040104>.
- [58] M. Foti and M. Vavalis, "Intelligent Bidding in Smart Electricity Markets", English, *International Journal of Monitoring and Surveillance Technologies Research*, vol. 3, no. 3, pp. 68–90, Jul. 2015, ISSN: 2166-7241. DOI: 10.4018/IJMSTR.2015070104.

- [59] Y. Liu, S. Hu, H. Huang, R. Ranjan, A. Y. Zomaya, and L. Wang, "Game-Theoretic Market-Driven Smart Home Scheduling Considering Energy Balancing", *IEEE Systems Journal*, vol. PP, no. 99, pp. 1–12, 2015, ISSN: 1932-8184. DOI: [10.1109/JSYST.2015.2418032](https://doi.org/10.1109/JSYST.2015.2418032).
- [60] A. H. Mohsenian-Rad and A. Leon-Garcia, "Optimal Residential Load Control With Price Prediction in Real-Time Electricity Pricing Environments", *IEEE Transactions on Smart Grid*, vol. 1, no. 2, pp. 120–133, Sep. 2010, ISSN: 1949-3053. DOI: [10.1109/TSG.2010.2055903](https://doi.org/10.1109/TSG.2010.2055903).
- [61] T. Agarwal and S. Cui, "Noncooperative Games for Autonomous Consumer Load Balancing over Smart Grid", in *Game Theory for Networks: Third International ICST Conference, GameNets 2012, Vancouver, BC, Canada, May 24-26, 2012, Revised Selected Papers*, V. Krishnamurthy, Q. Zhao, M. Huang, and Y. Wen, Eds. Berlin, Heidelberg: Springer Berlin Heidelberg, 2012, pp. 163–175, ISBN: 978-3-642-35582-0. DOI: [10.1007/978-3-642-35582-0_13](https://doi.org/10.1007/978-3-642-35582-0_13).
- [62] J. Nash, "Non-cooperative games", *Annals of mathematics*, pp. 286–295, 1951.
- [63] K. Ma, G. Hu, and C. J. Spanos, "Distributed Energy Consumption Control via Real-Time Pricing Feedback in Smart Grid", *IEEE Transactions on Control Systems Technology*, vol. 22, no. 5, pp. 1907–1914, Sep. 2014, ISSN: 1063-6536. DOI: [10.1109/TCST.2014.2299959](https://doi.org/10.1109/TCST.2014.2299959).
- [64] T. Kohonen, *MATLAB Implementations and Applications of the Self-Organizing Map*. Helsinki, Finland: Unigrafia Oy, 2014, ISBN: 9789526036786. [Online]. Available: http://docs.unigrafia.fi/publications/kohonen_teuvo/index.html.
- [65] Z. A. Baig, S. Ahmad, and S. M. Sait, "Detecting Intrusive Activity in the Smart Grid Communications Infrastructure Using Self-Organizing Maps", in *2013 12th IEEE International Conference on Trust, Security and Privacy in Computing and Communications*, IEEE, Jul. 2013, pp. 1594–1599, ISBN: 978-0-7695-5022-0. DOI: [10.1109/TrustCom.2013.196](https://doi.org/10.1109/TrustCom.2013.196). [Online]. Available: <http://ieeexplore.ieee.org/document/6681021/>.
- [66] M. Mononen, J. Saarenpaa, M. Kolehmainen, H. Niska, and A. Rautiainen, "Monetary impact of dynamic pricing and demand response on households: The winners and losers", in *2015 IEEE Power & Energy Society Innovative Smart Grid Technologies Conference (ISGT)*, IEEE, Feb. 2015, pp. 1–5, ISBN: 978-1-4799-1785-3. DOI: [10.1109/ISGT.2015.7131818](https://doi.org/10.1109/ISGT.2015.7131818). [Online]. Available: <http://ieeexplore.ieee.org/document/7131818/>.
- [67] S. Park, S. Ryu, Y. Choi, and H. Kim, "A framework for baseline load estimation in demand response: Data mining approach", in *2014 IEEE International Conference on Smart Grid Communications (SmartGridComm)*, IEEE, Nov. 2014, pp. 638–643, ISBN: 978-1-4799-4934-2. DOI: [10.1109/SmartGridComm.2014.7007719](https://doi.org/10.1109/SmartGridComm.2014.7007719). [Online]. Available: <http://ieeexplore.ieee.org/document/7007719/>.
- [68] N. I. Voropai, V. Kurbatsky, N. V. Tomin, and D. A. Panasetzky, "Preventive and emergency control of intelligent power systems", in *2012 3rd IEEE PES Innovative Smart Grid Technologies Europe (ISGT Europe)*, IEEE, Oct. 2012, pp. 1–7, ISBN: 978-1-4673-2597-4. DOI: [10.1109/ISGTEurope.2012.6465633](https://doi.org/10.1109/ISGTEurope.2012.6465633). [Online]. Available: <http://ieeexplore.ieee.org/document/6465633/>.

- [69] H. Niska, "Extracting controllable heating loads from aggregated smart meter data using clustering and predictive modelling", in *2013 IEEE Eighth International Conference on Intelligent Sensors, Sensor Networks and Information Processing*, IEEE, Apr. 2013, pp. 368–373, ISBN: 978-1-4673-5501-8. DOI: [10.1109/ISSNIP.2013.6529818](https://doi.org/10.1109/ISSNIP.2013.6529818). [Online]. Available: <http://ieeexplore.ieee.org/document/6529818/>.
- [70] D. P. Chassin, J. C. Fuller, and N. Djilali, "GridLAB-D: An Agent-Based Simulation Framework for Smart Grids", *Journal of Applied Mathematics*, vol. 2014, pp. 1–12, May 2014, ISSN: 1110-757X. DOI: [10.1155/2014/492320](https://doi.org/10.1155/2014/492320). [Online]. Available: http://www.researchgate.net/publication/262302530_GridLAB-D_An_agent-based_simulation_framework_for_smart_grids.
- [71] R. Fainti, A. Nasiakou, E. Tsoukalas, and M. Vavalis, "Design and Early Simulations of Next Generation Intelligent Energy Systems", *Int. J. Monit. Surveill. Technol. Res.*, vol. 2, no. 2, pp. 58–82, Apr. 2014, ISSN: 2166-7241. DOI: [10.4018/ijmstr.2014040104](https://doi.org/10.4018/ijmstr.2014040104). [Online]. Available: <http://dx.doi.org/10.4018/ijmstr.2014040104>.
- [72] M. Alamaniotis, D. Bargiotas, N. G. Bourbakis, and L. H. Tsoukalas, "Genetic Optimal Regression of Relevance Vector Machines for Electricity Pricing Signal Forecasting in Smart Grids", *IEEE Transactions on Smart Grid*, 2015, Article in Press.
- [73] C. Wan, Z. Xu, Y. Wang, Z. Dong, and K. Wong, "A hybrid approach for probabilistic forecasting of electricity price", *IEEE Transactions on Smart Grid*, vol. 5, no. 1, pp. 463–470, 2014.
- [74] M. Akbarpour, S. Esmailnia, M. Lohi, and H. Khalilifar, "Optimal operation of a microgrid in the power market environment by PSO algorithm", *Life Science Journal*, vol. 9, no. 4, pp. 160–170, 2012, ISSN: 10978135. [Online]. Available: <http://www.scopus.com/inward/record.url?eid=2-s2.0-84877072170&partnerID=tZ0tx3y1>.
- [75] M. Carvalho, C. Perez, and A. Granados, "An adaptive multi-agent-based approach to smart grids control and optimization", English, *Energy Systems*, vol. 3, no. 1, pp. 61–76, 2012, ISSN: 1868-3967. DOI: [10.1007/s12667-012-0054-0](https://doi.org/10.1007/s12667-012-0054-0). [Online]. Available: <http://dx.doi.org/10.1007/s12667-012-0054-0>.
- [76] M. Vlachopoulou, G. Chin, J. C. Fuller, S. Lu, and K. Kalsi, "Model for Aggregated Water Heater Load Using Dynamic Bayesian Networks", in R. Stahlbock and GM Weiss; CSREA Press, Athens, GA., Jul. 2012.
- [77] D. Urieli and P. Stone, "A Learning Agent for Heat-pump Thermostat Control", in *Proceedings of the 2013 International Conference on Autonomous Agents and Multi-agent Systems*, ser. AAMAS '13, St. Paul, MN, USA, 2013, pp. 1093–1100, ISBN: 978-1-4503-1993-5. [Online]. Available: <http://dl.acm.org/citation.cfm?id=2484920.2485092>.
- [78] Q. Wu and J. Guo, "Optimal bidding strategies in electricity markets using reinforcement learning", *Electric Power Components and Systems*, vol. 32, no. 2, pp. 175–192, 2004.

- [79] T. Pinto, Z. Vale, F. Rodrigues, H. Morais, and I. Praça, "Bid definition method for electricity markets based on an adaptive multiagent system", in *Advances on Practical Applications of Agents and Multiagent Systems*, Springer, 2011, pp. 309–316.
- [80] P. Reddy and M. Veloso, "Strategy learning for autonomous agents in smart grid markets", in *IJCAI Proceedings-International Joint Conference on Artificial Intelligence*, vol. 22, 2011, p. 1446.
- [81] D. E. King, "Dlib-ml: A Machine Learning Toolkit", *Journal of Machine Learning Research*, vol. 10, pp. 1755–1758, 2009.
- [82] A. Brandenburger, "Cooperative Game Theory : Characteristic Functions, Allocations, Marginal Contribution", Teaching Materials at New York University, Tech. Rep., 2007. [Online]. Available: http://www.uib.cat/depart/deeweb/pdi/hdeelbm0/arxiu_decisions_and_games/cooperative_game_theory-brandenburger.pdf.
- [83] Y. Liu, S. Hu, H. Huang, R. Ranjan, A. Y. Zomaya, and L. Wang, "Game-Theoretic Market-Driven Smart Home Scheduling Considering Energy Balancing", *IEEE Systems Journal*, vol. 11, no. 2, pp. 910–921, Jun. 2017, ISSN: 1932-8184. DOI: 10.1109/JSYST.2015.2418032. [Online]. Available: <http://ieeexplore.ieee.org/document/7104067/>.
- [84] A.-H. Mohsenian-Rad and A. Leon-Garcia, "Optimal Residential Load Control With Price Prediction in Real-Time Electricity Pricing Environments", *IEEE Transactions on Smart Grid*, vol. 1, no. 2, pp. 120–133, Sep. 2010, ISSN: 1949-3053. DOI: 10.1109/TSG.2010.2055903. [Online]. Available: <http://ieeexplore.ieee.org/document/5540263/>.
- [85] A.-H. Mohsenian-Rad, V. W. S. Wong, J. Jatskevich, R. Schober, and A. Leon-Garcia, "Autonomous Demand-Side Management Based on Game-Theoretic Energy Consumption Scheduling for the Future Smart Grid", *IEEE Transactions on Smart Grid*, vol. 1, no. 3, pp. 320–331, Dec. 2010, ISSN: 1949-3053. DOI: 10.1109/TSG.2010.2089069. [Online]. Available: <http://ieeexplore.ieee.org/document/5628271/>.
- [86] Y. Wang, W. Saad, Z. Han, H. V. Poor, and T. Basar, "A Game-Theoretic Approach to Energy Trading in the Smart Grid", *IEEE Transactions on Smart Grid*, vol. 5, no. 3, pp. 1439–1450, May 2014, ISSN: 1949-3053. DOI: 10.1109/TSG.2013.2284664. [Online]. Available: <http://ieeexplore.ieee.org/document/6798766/>.
- [87] T. Agarwal and S. Cui, "Noncooperative Games for Autonomous Consumer Load Balancing over Smart Grid", in Springer, Berlin, Heidelberg, 2012, pp. 163–175. DOI: 10.1007/978-3-642-35582-0_{_}13. [Online]. Available: http://link.springer.com/10.1007/978-3-642-35582-0_13.
- [88] K. Ma, G. Hu, and C. J. Spanos, "Distributed Energy Consumption Control via Real-Time Pricing Feedback in Smart Grid", *IEEE Transactions on Control Systems Technology*, vol. 22, no. 5, pp. 1907–1914, Sep. 2014, ISSN: 1063-6536. DOI: 10.1109/TCST.2014.2299959. [Online]. Available: <http://ieeexplore.ieee.org/document/6730904/>.
- [89] G. Taguchi, S. Chowdhury, and Y. Wu, *Taguchi's Quality Engineering Handbook*. Hoboken, NJ, USA: John Wiley & Sons, Inc., Oct. 2004, ISBN: 9780470258354. DOI: 10.1002/9780470258354. [Online]. Available: <http://doi.wiley.com/10.1002/9780470258354>.

- [90] L. Chen, N. Li, L. Jiang, and S. H. Low, "Optimal Demand Response: Problem Formulation and Deterministic Case", in *Control and Optimization Methods for Electric Smart Grids*, New York, NY: Springer New York, 2012, pp. 63–85. DOI: 10.1007/978-1-4614-1605-0_{\ }3. [Online]. Available: http://link.springer.com/10.1007/978-1-4614-1605-0_3.
- [91] Z. M. Fadlullah, Y. Nozaki, A. Takeuchi, and N. Kato, "A survey of game theoretic approaches in smart grid", in *2011 International Conference on Wireless Communications and Signal Processing (WCSP)*, IEEE, Nov. 2011, pp. 1–4, ISBN: 978-1-4577-1010-0. DOI: 10.1109/WCSP.2011.6096962. [Online]. Available: <http://ieeexplore.ieee.org/document/6096962/>.
- [92] B. Gao, X. Liu, W. Zhang, Y. Tang, B. Gao, X. Liu, W. Zhang, and Y. Tang, "Autonomous Household Energy Management Based on a Double Cooperative Game Approach in the Smart Grid", *Energies*, vol. 8, no. 7, pp. 7326–7343, Jul. 2015, ISSN: 1996-1073. DOI: 10.3390/en8077326. [Online]. Available: <http://www.mdpi.com/1996-1073/8/7/7326>.
- [93] *Bitcoin Mining Has a Massive Carbon Footprint | WIRED*. [Online]. Available: <https://www.wired.com/story/bitcoin-mining-guzzles-energyand-its-carbon-footprint-just-keeps-growing/>.
- [94] K Christidis and M Devetsikiotis, "Blockchains and Smart Contracts for the Internet of Things", *IEEE Access*, vol. 4, pp. 2292–2303, 2016, ISSN: 2169-3536. DOI: 10.1109/ACCESS.2016.2566339. [Online]. Available: <http://ieeexplore.ieee.org/stamp/stamp.jsp?tp=&arnumber=7467408&isnumber=7419931>.
- [95] *The Energy Blockchain: How Bitcoin Could Be a Catalyst for the Distributed Grid*. [Online]. Available: <https://www.greentechmedia.com/articles/read/the-energy-blockchain-could-bitcoin-be-a-catalyst-for-the-distributed-grid>.
- [96] J. Green and P. Newman, "Citizen utilities: The emerging power paradigm", *Energy Policy*, vol. 105, pp. 283–293, Jun. 2017, ISSN: 0301-4215. DOI: 10.1016/J.ENPOL.2017.02.004.
- [97] H. Felix, v. P. Axel, H. Thomas, S. Erwin, L. Lena, and C. Maximilian, "Blockchain – an opportunity for energy producers and consumers?", PwC, Tech. Rep., 2016. [Online]. Available: <https://www.pwc.com/gx/en/industries/assets/pwc-blockchain-opportunity-for-energy-producers-and-consumers.pdf>.
- [98] G. Dütsch and N. Steinecke, "Use Cases for Blockchain Technology in Energy & Commodity Trading", PwC, Tech. Rep., 2017. [Online]. Available: <https://www.pwc.com/gx/en/industries/assets/blockchain-technology-in-energy.pdf>.
- [99] Indigo Advisory Group, "Blockchain in Energy and Utilities", Tech. Rep. [Online]. Available: <https://www.indigoadvisorygroup.com/blockchain>.
- [100] D. Ellis, *Promising Blockchain Applications for Energy: Separating the Signal from the Noise*, 2018. [Online]. Available: https://www.energycentral.com/system/files/ece/nodes/307569/efi_blockchain_july2018.pdf.

- [101] M. N. Luke, S. J. Lee, Z. Pekarek, and A. Dimitrova, "Blockchain in Electricity: a Critical Review of Progress to Date", NERA Economic Consulting, eurelectric, Tech. Rep., 2018. [Online]. Available: http://www.energie-nachrichten.info/file/01Energie-NachrichtenNews/2018-05/80503_Eurelectric_1_blockchain_eurelectric-h-DE808259.pdf.
- [102] E. Munsing, J. Mather, and S. Moura, "Blockchains for decentralized optimization of energy resources in microgrid networks", in *2017 IEEE Conference on Control Technology and Applications (CCTA)*, IEEE, Aug. 2017, pp. 2164–2171, ISBN: 978-1-5090-2182-6. DOI: [10.1109/CCTA.2017.8062773](https://doi.org/10.1109/CCTA.2017.8062773).
- [103] K. Mavromatis, M. Foti, and M. Vavalis, "Blockchain Design and Implementation for Decentralized Optimal Power Flow", 2018. DOI: [10.6084/m9.figshare.7093835.v1](https://doi.org/10.6084/m9.figshare.7093835.v1). [Online]. Available: https://figshare.com/articles/Blockchain_Design_and_Implementation_for_Decentralized_Optimal_Power_Flow/7093835.
- [104] P. Danzi, M. Angjelichinoski, C. Stefanovic, and P. Popovski, "Distributed proportional-fairness control in microgrids via blockchain smart contracts", in *2017 IEEE International Conference on Smart Grid Communications (SmartGridComm)*, IEEE, Oct. 2017, pp. 45–51, ISBN: 978-1-5386-0943-9. DOI: [10.1109/SmartGridComm.2017.8340713](https://doi.org/10.1109/SmartGridComm.2017.8340713). [Online]. Available: <https://ieeexplore.ieee.org/document/8340713/>.
- [105] K. N. Khaqqi, J. J. Sikorski, K. Hadinoto, and M. Kraft, "Incorporating seller/buyer reputation-based system in blockchain-enabled emission trading application", *Applied Energy*, vol. 209, pp. 8–19, 2018, ISSN: 03062619. DOI: [10.1016/j.apenergy.2017.10.070](https://doi.org/10.1016/j.apenergy.2017.10.070). [Online]. Available: <https://www.scopus.com/inward/record.uri?eid=2-s2.0-85032373397&doi=10.1016%2Fj.apenergy.2017.10.070&partnerID=40&md5=5402dd809c1752b94fd813b612fc01c7>.
- [106] J. A. F. Castellanos, D. Coll-Mayor, and J. A. Notholt, "Cryptocurrency as guarantees of origin: Simulating a green certificate market with the Ethereum Blockchain", in *2017 5th IEEE International Conference on Smart Energy Grid Engineering, SEGE 2017*, Institute of Electrical and Electronics Engineers Inc., 2017, pp. 367–372, ISBN: 9781538617755. DOI: [10.1109/SEGE.2017.8052827](https://doi.org/10.1109/SEGE.2017.8052827).
- [107] E. Mengelkamp, J. Gärttner, K. Rock, S. Kessler, L. Orsini, and C. Weinhardt, "Designing microgrid energy markets: A case study: The Brooklyn Microgrid", *Applied Energy*, vol. 210, pp. 870–880, Jan. 2018, ISSN: 0306-2619. DOI: [10.1016/J.APENERGY.2017.06.054](https://doi.org/10.1016/J.APENERGY.2017.06.054).
- [108] J. J. Sikorski, J. Haughton, and M. Kraft, "Blockchain technology in the chemical industry: Machine-to-machine electricity market", *Applied Energy*, vol. 195, pp. 234–246, Jun. 2017, ISSN: 0306-2619. DOI: [10.1016/J.APENERGY.2017.03.039](https://doi.org/10.1016/J.APENERGY.2017.03.039).
- [109] M. Sabounchi and J. Wei, "Towards resilient networked microgrids: Blockchain-enabled peer-to-peer electricity trading mechanism", in *2017 IEEE Conference on Energy Internet and Energy System Integration (EI2)*, IEEE, Nov. 2017, pp. 1–5, ISBN: 978-1-5386-1427-3. DOI: [10.1109/EI2.2017.8245449](https://doi.org/10.1109/EI2.2017.8245449). [Online]. Available: <http://ieeexplore.ieee.org/document/8245449/>.
- [110] D. Vangulick, B. Cornélusse, and D. Ernst, "Blockchain for peer-to-peer energy exchanges: design and recommendations", in *Power System Computation Conference*, Dublin, 2018.

- [111] L. Park, S. Lee, and H. Chang, "A Sustainable Home Energy Prosumer-Chain Methodology with Energy Tags over the Blockchain", *Sustainability*, vol. 10, no. 3, p. 658, Mar. 2018, ISSN: 2071-1050. DOI: 10.3390/su10030658. [Online]. Available: <http://www.mdpi.com/2071-1050/10/3/658>.
- [112] S Cheng, B Zeng, and Y. Z. Huang, "Research on application model of blockchain technology in distributed electricity market", in *IOP Conference Series: Earth and Environmental Science*, K. G.L., Ed., vol. 93, Institute of Physics Publishing, 2017. DOI: 10.1088/1755-1315/93/1/012065. [Online]. Available: <https://www.scopus.com/inward/record.uri?eid=2-s2.0-85034961143&doi=10.1088%2F1755-1315%2F93%2F1%2F012065&partnerID=40&md5=76142ec44b2e9fab991a34f3a32047aa>.
- [113] E. Sanseverino, M. Silvestre, P. Gallo, G. Zizzo, and M. Ippolito, "The blockchain in microgrids for transacting energy and attributing losses", in *Proceedings - 2017 IEEE International Conference on Internet of Things, IEEE Green Computing and Communications, IEEE Cyber, Physical and Social Computing, IEEE Smart Data, iThings-GreenCom-CPSCoM-SmartData 2017*, vol. 2018-Janua, 2018, pp. 925-930, ISBN: 9781538630655. DOI: 10.1109/iThings-GreenCom-CPSCoM-SmartData.2017.142.
- [114] M. L. Di Silvestre, L. Dusonchet, S. Favuzza, M. G. Ippolito, S. Mangione, F. Massaro, L. Mineo, E. R. Sanseverino, E. Telaretti, and G. Zizzo, "Transparency in transactive energy at distribution level", in *2017 AEIT International Annual Conference*, IEEE, Sep. 2017, pp. 1-5, ISBN: 978-8-8872-3737-5. DOI: 10.23919/AEIT.2017.8240568. [Online]. Available: <http://ieeexplore.ieee.org/document/8240568/>.
- [115] G. Zizzo, E. Riva Sanseverino, M. G. Ippolito, M. L. Di Silvestre, and P. Gallo, "A Technical Approach to P2P Energy Transactions in Microgrids", *IEEE Transactions on Industrial Informatics*, pp. 1-1, Feb. 2018, ISSN: 1551-3203. DOI: 10.1109/TII.2018.2806357.
- [116] E Mengelkamp, J Gärttner, and C Weinhardt, "Decentralizing Energy Systems Through Local Energy Markets : The LAMP-Project", in *Multikonferenz Wirtschaftsinformatik, MKWI 2018, Lüneburg, 06. - 09. März 2018*, 2018. [Online]. Available: <https://publikationen.bibliothek.kit.edu/1000081064>.
- [117] E Mengelkamp, B Notheisen, C Beer, D Dauer, and C Weinhardt, "A blockchain-based smart grid: towards sustainable local energy markets", *Computer Science - Research and Development*, pp. 1-8, 2017, ISSN: 18652034. DOI: 10.1007/s00450-017-0360-9. [Online]. Available: <https://www.scopus.com/inward/record.uri?eid=2-s2.0-85027865079&doi=10.1007%2Fs00450-017-0360-9&partnerID=40&md5=5d755934c951522c07e2740cf84ba2bf>.
- [118] M. Foti, D. Greasidis, and M. Vavalis, "Viability analysis of a decentralized energy market based on blockchain", in *15th International Conference on the European Energy Market*, 2018, pp. 1-6.
- [119] J. Wang, Q. Wang, N. Zhou, and Y. Chi, "A Novel Electricity Transaction Mode of Microgrids Based on Blockchain and Continuous Double Auction", *Energies*, vol. 10, no. 12, p. 1971, Nov. 2017, ISSN: 1996-1073. DOI: 10.3390/en10121971.

- [120] S. Zhao, B. Wang, Y. Li, Y. Li, S. Zhao, B. Wang, Y. Li, and Y. Li, "Integrated Energy Transaction Mechanisms Based on Blockchain Technology", *Energies*, vol. 11, no. 9, p. 2412, Sep. 2018, ISSN: 1996-1073. DOI: 10.3390/en11092412. [Online]. Available: <http://www.mdpi.com/1996-1073/11/9/2412>.
- [121] J. Ferreira, A. Martins, J. C. Ferreira, and A. L. Martins, "Building a Community of Users for Open Market Energy", *Energies*, vol. 11, no. 9, p. 2330, Sep. 2018, ISSN: 1996-1073. DOI: 10.3390/en11092330. [Online]. Available: <http://www.mdpi.com/1996-1073/11/9/2330>.
- [122] I Kounelis, G Steri, R Giuliani, D Geneiatakis, R Neisse, and I Nai-Fovino, "Fostering consumers' energy market through smart contracts", in *Energy and Sustainability in Small Developing Economies, ES2DE 2017 - Proceedings*, Institute of Electrical and Electronics Engineers Inc., 2017, ISBN: 9781538620663. DOI: 10.1109/ES2DE.2017.8015343. [Online]. Available: <https://www.scopus.com/inward/record.uri?eid=2-s2.0-85030331021&doi=10.1109%2FES2DE.2017.8015343&partnerID=40&md5=1c8fae94332586803839e865a122f0fe>.
- [123] A Hahn, R Singh, C.-C. Liu, and S Chen, "Smart contract-based campus demonstration of decentralized transactive energy auctions", in *2017 IEEE Power and Energy Society Innovative Smart Grid Technologies Conference, ISGT 2017*, Institute of Electrical and Electronics Engineers Inc., 2017, ISBN: 9781538628904. DOI: 10.1109/ISGT.2017.8086092. [Online]. Available: <https://www.scopus.com/inward/record.uri?eid=2-s2.0-85040169380&doi=10.1109%2FISGT.2017.8086092&partnerID=40&md5=dc6476740d30e159ead6bdbc9c9458a7>.
- [124] K. Mannaro, A. Pinna, and M. Marchesi, "Crypto-trading: Blockchain-oriented energy market", in *2017 AEIT International Annual Conference, IEEE*, Sep. 2017, pp. 1–5, ISBN: 978-8-8872-3737-5. DOI: 10.23919/AEIT.2017.8240547. [Online]. Available: <http://ieeexplore.ieee.org/document/8240547/>.
- [125] A. Lüth, J. M. Zepter, P. Crespo del Granado, and R. Egging, "Local electricity market designs for peer-to-peer trading: The role of battery flexibility", *Applied Energy*, vol. 229, pp. 1233–1243, Nov. 2018, ISSN: 03062619. DOI: 10.1016/j.apenergy.2018.08.004. [Online]. Available: <https://linkinghub.elsevier.com/retrieve/pii/S0306261918311590>.
- [126] J. Schlund, L. Ammon, and R. German, "ETHome: Open-source blockchain based energy community controller", in *Proceedings of the Ninth International Conference on Future Energy Systems - e-Energy '18*, New York, New York, USA: ACM Press, 2018, pp. 319–323, ISBN: 9781450357678. DOI: 10.1145/3208903.3208929. [Online]. Available: <http://dl.acm.org/citation.cfm?doid=3208903.3208929>.
- [127] C. Pop, T. Cioara, M. Antal, I. Anghel, I. Salomie, and M. Bertoncini, "Blockchain Based Decentralized Management of Demand Response Programs in Smart Energy Grids", *Sensors*, vol. 18, no. 1, p. 162, Jan. 2018, ISSN: 1424-8220. DOI: 10.3390/s18010162.
- [128] S. Noor, W. Yang, M. Guo, K. H. van Dam, and X. Wang, "Energy Demand Side Management within micro-grid networks enhanced by blockchain", *Applied Energy*, vol. 228, pp. 1385–1398, Oct. 2018, ISSN: 0306-2619. DOI: 10.1016/J.APENERGY.2018.07.012. [Online]. Available: <https://www>.

- sciencedirect.com/science/article/pii/S0306261918310390?via%3Dihub.
- [129] T. Zhang, H. Pota, C.-C. Chu, and R. Gadh, "Real-time renewable energy incentive system for electric vehicles using prioritization and cryptocurrency", *Applied Energy*, vol. 226, pp. 582–594, Sep. 2018, ISSN: 0306-2619. DOI: 10.1016/J.APENERGY.2018.06.025. [Online]. Available: <https://www.sciencedirect.com/science/article/pii/S0306261918308912?via%3Dihub>.
- [130] J Kang, R Yu, X Huang, S Maharjan, Y Zhang, and E Hossain, "Enabling Localized Peer-to-Peer Electricity Trading among Plug-in Hybrid Electric Vehicles Using Consortium Blockchains", *IEEE Transactions on Industrial Informatics*, vol. 13, no. 6, pp. 3154–3164, 2017, ISSN: 15513203. DOI: 10.1109/TII.2017.2709784.
- [131] X. Huang, Y. Zhang, D. Li, and L. Han, "An optimal scheduling algorithm for hybrid EV charging scenario using consortium blockchains", *Future Generation Computer Systems*, vol. 91, pp. 555–562, Feb. 2019, ISSN: 0167-739X. DOI: 10.1016/J.FUTURE.2018.09.046. [Online]. Available: <https://www.sciencedirect.com/science/article/pii/S0167739X18313578?via%3Dihub>.
- [132] C. Liu, K. K. Chai, X. Zhang, E. T. Lau, and Y. Chen, "Adaptive Blockchain-based Electric Vehicle Participation Scheme in Smart Grid Platform", *IEEE Access*, pp. 1–1, 2018, ISSN: 2169-3536. DOI: 10.1109/ACCESS.2018.2835309.
- [133] X. Huang, C. Xu, P. Wang, and H. Liu, "LNSC: A Security Model for Electric Vehicle and Charging Pile Management based on Blockchain Ecosystem", *IEEE Access*, pp. 1–1, Mar. 2018, ISSN: 2169-3536. DOI: 10.1109/ACCESS.2018.2812176. [Online]. Available: <http://ieeexplore.ieee.org/document/8306865/>.
- [134] M. Pustisek, A. Kos, and U. Sedlar, "Blockchain Based Autonomous Selection of Electric Vehicle Charging Station", in *2016 International Conference on Identification, Information and Knowledge in the Internet of Things (IIKI)*, IEEE, Oct. 2016, pp. 217–222, ISBN: 978-1-5090-5952-2. DOI: 10.1109/IIKI.2016.60. [Online]. Available: <http://ieeexplore.ieee.org/document/8281203/>.
- [135] F Knirsch, A Unterweger, and D Engel, "Privacy-preserving blockchain-based electric vehicle charging with dynamic tariff decisions", *Computer Science - Research and Development*, pp. 1–9, 2017, ISSN: 18652034. DOI: 10.1007/s00450-017-0348-5. [Online]. Available: <https://www.scopus.com/inward/record.uri?eid=2-s2.0-85028815019&doi=10.1007%2Fs00450-017-0348-5&partnerID=40&md5=1e43efc002863c27cbc96e7beec7132b>.
- [136] A. R. Pedrosa and G. Pau, "ChargeltUp: On Blockchain-based technologies for Autonomous Vehicles", in *Proceedings of the 1st Workshop on Cryptocurrencies and Blockchains for Distributed Systems - CryBlock'18*, New York, New York, USA: ACM Press, 2018, pp. 87–92, ISBN: 9781450358385. DOI: 10.1145/3211933.3211949. [Online]. Available: <http://dl.acm.org/citation.cfm?doid=3211933.3211949>.
- [137] N. H. Kim, S. M. Kang, and C. S. Hong, "Mobile charger billing system using lightweight Blockchain", in *2017 19th Asia-Pacific Network Operations and*

- Management Symposium (APNOMS)*, IEEE, Sep. 2017, pp. 374–377, ISBN: 978-1-5386-1101-2. DOI: [10.1109/APNOMS.2017.8094151](https://doi.org/10.1109/APNOMS.2017.8094151). [Online]. Available: <http://ieeexplore.ieee.org/document/8094151/>.
- [138] M Mylrea and S. N. G. Gourisetti, “Blockchain for smart grid resilience: Exchanging distributed energy at speed, scale and security”, in *Proceedings - 2017 Resilience Week, RWS 2017*, Institute of Electrical and Electronics Engineers Inc., 2017, pp. 18–23, ISBN: 9781509060559. DOI: [10.1109/RWEEK.2017.8088642](https://doi.org/10.1109/RWEEK.2017.8088642).
- [139] M. Mylrea and S. N. G. Gourisetti, “Blockchain: A path to grid modernization and cyber resiliency”, in *2017 North American Power Symposium (NAPS)*, IEEE, Sep. 2017, pp. 1–5, ISBN: 978-1-5386-2699-3. DOI: [10.1109/NAPS.2017.8107313](https://doi.org/10.1109/NAPS.2017.8107313).
- [140] J. Gao, K. O. Asamoah, E. B. Sifah, A. Smahi, Q. Xia, H. Xia, X. Zhang, and G. Dong, “GridMonitoring: Secured Sovereign Blockchain Based Monitoring on Smart Grid”, *IEEE Access*, vol. 6, pp. 9917–9925, 2018, ISSN: 2169-3536. DOI: [10.1109/ACCESS.2018.2806303](https://doi.org/10.1109/ACCESS.2018.2806303). [Online]. Available: <http://ieeexplore.ieee.org/document/8303679/>.
- [141] S. Khan, R. Khan, S. Khan, and R. Khan, “Multiple Authorities Attribute-Based Verification Mechanism for Blockchain Mircogrid Transactions”, *Energies*, vol. 11, no. 5, p. 1154, May 2018, ISSN: 1996-1073. DOI: [10.3390/en11051154](https://doi.org/10.3390/en11051154). [Online]. Available: <http://www.mdpi.com/1996-1073/11/5/1154>.
- [142] A Laszka, A Dubey, M Walker, and D Schmidt, “Providing privacy, safety, and security in IoT-based transactive energy systems using distributed ledgers”, in *ACM International Conference Proceeding Series*, vol. Part F1327, Association for Computing Machinery, 2017, ISBN: 9781450353182. DOI: [10.1145/3131542.3131562](https://doi.org/10.1145/3131542.3131562). [Online]. Available: <https://www.scopus.com/inward/record.uri?eid=2-s2.0-85040309688&doi=10.1145%2F3131542.3131562&partnerID=40&md5=b0e1186ffe0e254b0f3e68f1b3a53187>.
- [143] J. Bergquist, A. Laszka, M. Sturm, and A. Dubey, “On the design of communication and transaction anonymity in blockchain-based transactive microgrids”, in *Proceedings of the 1st Workshop on Scalable and Resilient Infrastructures for Distributed Ledgers - SERIAL '17*, New York, New York, USA: ACM Press, 2017, pp. 1–6, ISBN: 9781450351737. DOI: [10.1145/3152824.3152827](https://doi.org/10.1145/3152824.3152827).
- [144] C. DeCusatis and K. Lotay, “Secure, Decentralized Energy Resource Management Using the Ethereum Blockchain”, in *2018 17th IEEE International Conference On Trust, Security And Privacy In Computing And Communications/ 12th IEEE International Conference On Big Data Science And Engineering (Trust-Com/BigDataSE)*, IEEE, Aug. 2018, pp. 1907–1913, ISBN: 978-1-5386-4388-4. DOI: [10.1109/TrustCom/BigDataSE.2018.00290](https://doi.org/10.1109/TrustCom/BigDataSE.2018.00290). [Online]. Available: <http://ieeexplore.ieee.org/document/8456158/>.
- [145] A Goranovic, M Meisel, L Fotiadis, S Wilker, A Treytl, and T Sauter, “Blockchain applications in microgrids: An overview of current projects and concepts”, in *Proceedings IECON 2017 - 43rd Annual Conference of the IEEE Industrial Electronics Society*, vol. 2017-Janua, 2017, pp. 6153–6158. DOI: [10.1109/IECON.2017.8217069](https://doi.org/10.1109/IECON.2017.8217069).

- [146] T. Yang, Q. Guo, X. Tai, H. Sun, B. Zhang, W. Zhao, and C. Lin, "Applying blockchain technology to decentralized operation in future energy internet", in *2017 IEEE Conference on Energy Internet and Energy System Integration (EI2)*, IEEE, Nov. 2017, pp. 1–5, ISBN: 978-1-5386-1427-3. DOI: 10.1109/EI2.2017.8244418. [Online]. Available: <http://ieeexplore.ieee.org/document/8244418/>.
- [147] T. Fan, Q. He, E. Nie, and S. Chen, "A study of pricing and trading model of Blockchain & Big data-based Energy-Internet electricity", *IOP Conference Series: Earth and Environmental Science*, vol. 108, no. 5, p. 052083, Jan. 2018, ISSN: 1755-1307. DOI: 10.1088/1755-1315/108/5/052083. [Online]. Available: <http://stacks.iop.org/1755-1315/108/i=5/a=052083?key=crossref.2fedea2cf2843e6e05e80f59fd21c7>.
- [148] A. Pieroni, N. Scarpato, L. Di Nunzio, F. Fallucchi, and M. Raso, "Smarter City: Smart Energy Grid based on Blockchain Technology", *International Journal on Advanced Science, Engineering and Information Technology*, vol. 8, no. 1, p. 298, Feb. 2018, ISSN: 2460-6952. DOI: 10.18517/ijaseit.8.1.4954. [Online]. Available: http://ijaseit.insightsociety.org/index.php?option=com_content&view=article&id=9&Itemid=1&article_id=4954.
- [149] F. Imbault, M. Swiatek, R. De Beaufort, and R. Plana, "The green blockchain: Managing decentralized energy production and consumption", in *Conference Proceedings - 2017 17th IEEE International Conference on Environment and Electrical Engineering and 2017 1st IEEE Industrial and Commercial Power Systems Europe, IEEEIC / I and CPS Europe 2017*, Institute of Electrical and Electronics Engineers Inc., 2017, ISBN: 9781538639160. DOI: 10.1109/IEEEIC.2017.7977613. [Online]. Available: <https://www.scopus.com/inward/record.uri?eid=2-s2.0-85026776776&doi=10.1109%2FIEEEIC.2017.7977613&partnerID=40&md5=816886fb94c783449c93ce6cd88fa3fb>.
- [150] *P2P-SmarTest Project*. [Online]. Available: <http://www.p2psmartest-h2020.eu/>.
- [151] *CROSSBOW – CROSS BOrder management of variable renewable energies and storage units enabling a transnational Wholesale market*. [Online]. Available: <http://crossbowproject.eu/>.
- [152] *FutureFlow : Designing eTrading Solutions for Electricity Balancing and Redispatching in Europe*. [Online]. Available: <http://www.futureflow.eu/>.
- [153] *Defender – Defending the European Energy Infrastructures*. [Online]. Available: <http://defender-project.eu/>.
- [154] *eDREAM - new Demand Response technologies*. [Online]. Available: <http://edream-h2020.eu/>.
- [155] *Scalable, trustEd, and interoperAble pLatform for sEcureD smart GRID | Projects | H2020 | CORDIS | European Commission*. [Online]. Available: https://cordis.europa.eu/project/rcn/212986_en.html.
- [156] A. Karila, Y. Kortesiemi, D. Lagutin, P. Nikander, N. Fotiou, G. Polyzos, V. Siris, and T. Zahariadis, "SOFIE Secure Open Federation for Internet Everywhere", [Online]. Available: <https://mm.aueb.gr/tr/Sofie.pdf>.

- [157] C. Zhang, J. Wu, C. Long, and M. Cheng, "Review of Existing Peer-to-Peer Energy Trading Projects", *Energy Procedia*, vol. 105, pp. 2563–2568, May 2017, ISSN: 1876-6102. DOI: 10.1016/J.EGYPRO.2017.03.737. [Online]. Available: <https://www.sciencedirect.com/science/article/pii/S1876610217308007>.
- [158] PwC, *PwC's Global Blockchain Survey 2018*, 2018. [Online]. Available: http://explore.pwc.com/blockchain/Exec-summary?WT.mc_id=CT11-PL1000-DM2-TR1-LS4-ND30-TTA5-CN_US-GX-xLoSBlockchain-LB-PwCExecSum&eq=CT11-PL1000-DM2-CN_US-GX-xLoSBlockchain-LB-PwCExecSum.
- [159] *Brooklyn Microgrid*. [Online]. Available: <https://www.brooklyn.energy/>.
- [160] *Power Ledger White Paper*.
- [161] *Electron | Blockchain Systems for The Energy Sector*. [Online]. Available: http://www.electron.org.uk/index.html#our_products.
- [162] *TEPCO looks to the transformative potential of blockchain by investing in Electron, a UK energy technology company*. [Online]. Available: <https://www.acnnewswire.com/press-release/english/40952/>.
- [163] Consensus, "Grid+ White Paper", 2017. [Online]. Available: <https://gridplus.io/assets/Gridwhitepaper.pdf>.
- [164] "WePower White Paper", 2018. [Online]. Available: https://drive.google.com/file/d/0B_OW_EddX05RWWFVqJGZXpQT3c/view.
- [165] VLUX, "Verv VLUX White Paper - The Evolution of Energy", 2018. [Online]. Available: https://vlux.io/Vlux_Whitepaper_016.pdf.
- [166] Irene Energy, "Irene White Paper", 2018. [Online]. Available: https://drive.google.com/file/d/1d46P837NUOKAQu52QjAfuXbZWw_VB/view.
- [167] "The Blockchain Standard Infrastructure for Business", 2018, [Online]. Available: https://www.lition.io/docs/Lition_Whitepaper.pdf.
- [168] "Enosi White Paper", 2018. [Online]. Available: <https://enosi.io/images/file/whitepaper.pdf>.
- [169] *Share&Charge - Empowering Easy & Smart EV Charging Everywhere*. [Online]. Available: <https://shareandcharge.com/en/>.
- [170] *The next Share&Charge*. [Online]. Available: <https://medium.com/share-charge/the-next-share-charge-bc5f6807ddd6>.
- [171] *SolarCoin*. [Online]. Available: <https://solarcoin.org/>.
- [172] *Cooperation between Intelen and Piraeus University for Energy Exchange System between Consumers through Blockchain technology*. [Online]. Available: <http://www.epixeiro.gr/article/68609>.
- [173] *Exergy an LO3 ENERGY innovation*. [Online]. Available: <https://exergy.energy>.
- [174] S. CHEN and C.-C. LIU, "From demand response to transactive energy: state of the art", *Journal of Modern Power Systems and Clean Energy*, vol. 5, no. 1, pp. 10–19, Jan. 2017, ISSN: 2196-5625. DOI: 10.1007/s40565-016-0256-x.
- [175] D. Durgvanshi, B. P. Singh, and M. M. Gore, "Byzantine fault tolerance for real time price in hierarchical smart grid communication infrastructure", in *2016 IEEE 7th Power India International Conference (PIICON)*, IEEE, Nov. 2016, pp. 1–6, ISBN: 978-1-4673-8962-4. DOI: 10.1109/POWERI.2016.8077386.

- [176] T. Broeer, J. Fuller, F. Tuffner, D. Chassin, and N. Djilali, "Modeling framework and validation of a smart grid and demand response system for wind power integration", *Applied Energy*, vol. 113, pp. 199–207, Jan. 2014, ISSN: 0306-2619. DOI: [10.1016/J.APENERGY.2013.06.058](https://doi.org/10.1016/J.APENERGY.2013.06.058).
- [177] D. Kramer, "Models poised to boost grid efficiency", *Physics Today*, vol. 69, no. 9, pp. 25–27, Sep. 2016, ISSN: 0031-9228. DOI: [10.1063/PT.3.3293](https://doi.org/10.1063/PT.3.3293). [Online]. Available: <http://physicstoday.scitation.org/doi/10.1063/PT.3.3293>.
- [178] M. Foti and M. Vavalis, "Blockchain Based Efforts for Power Grids:A Review", 2018. DOI: [10.6084/m9.figshare.6199274.v2](https://doi.org/10.6084/m9.figshare.6199274.v2). [Online]. Available: <https://doi.org/10.6084/m9.figshare.6199274.v2>.
- [179] M Macdonald, L. Liu-Thorrold, and R Julien, *The Blockchain: A Comparison of Platforms and Their Uses Beyond Bitcoin*, 2017.
- [180] G. Wood, "Ethereum: A secure decentralised generalised transaction ledger", *Ethereum Project Yellow Paper*, vol. 151, pp. 1–32, 2014.
- [181] *Solidity — Solidity 0.4.21 documentation*. [Online]. Available: <http://solidity.readthedocs.io/en/v0.4.21/>.
- [182] N. Akram, S. De Silva, M. Foti, M. Jayasinghe, M. Dayarathna, M. Vavalis, and S. Perera, "Real time data analytics platform for power grid smart applications", in *International Conference on the European Energy Market, EEM, 2017*, ISBN: 9781509054992. DOI: [10.1109/EEM.2017.7982012](https://doi.org/10.1109/EEM.2017.7982012).
- [183] M. Foti, *CPP wrapper for json-rpc calls to ethereum node*, 2017. [Online]. Available: <https://github.com/mafoti/ethereum-cpp-rpc-calls>.
- [184] —, *GridLAB-D with blockchain functionalities*, 2017. [Online]. Available: <https://github.com/mafoti/blockchain-gridlabd>.
- [185] F. Postigo Marcos, C. Mateo Domingo, T. Gómez San Román, B. Palmintier, B.-M. Hodge, V. Krishnan, F. de Cuadra García, B. Mather, F. E. Postigo Marcos, C. Mateo Domingo, T. Gómez San Román, B. Palmintier, B.-M. Hodge, V. Krishnan, F. de Cuadra García, and B. Mather, "A Review of Power Distribution Test Feeders in the United States and the Need for Synthetic Representative Networks", *Energies*, vol. 10, no. 11, p. 1896, Nov. 2017, ISSN: 1996-1073. DOI: [10.3390/en10111896](https://doi.org/10.3390/en10111896). [Online]. Available: <http://www.mdpi.com/1996-1073/10/11/1896>.
- [186] J. C. Fuller, K. P. Schneider, and D. Chassin, "Analysis of Residential Demand Response and double-auction markets", in *2011 IEEE Power and Energy Society General Meeting, IEEE*, Jul. 2011, pp. 1–7, ISBN: 978-1-4577-1000-1. DOI: [10.1109/PES.2011.6039827](https://doi.org/10.1109/PES.2011.6039827). [Online]. Available: <http://ieeexplore.ieee.org/document/6039827/>.
- [187] L. Luu, D.-H. Chu, H. Olickel, P. Saxena, and A. Hobor, "Making Smart Contracts Smarter", in *Proceedings of the 2016 ACM SIGSAC Conference on Computer and Communications Security - CCS'16*, New York, New York, USA: ACM Press, 2016, pp. 254–269, ISBN: 9781450341394. DOI: [10.1145/2976749.2978309](https://doi.org/10.1145/2976749.2978309).
- [188] M. Foti, D. Greasidis, and M. Vavalis, "Towards a debugging tool for decentralized applications", Univeristy of Thessaly, Volos, Tech. Rep., 2018, In preparation. [Online]. Available: <https://doi.org/10.5281/zenodo.1237085>.

- [189] E. Lazarczyk and C. L. Coq, "Information Disclosure Rules in the European Electricity Market: An Overview", in *2018 15th International Conference on the European Energy Market (EEM)*, IEEE, Jun. 2018, pp. 1–4, ISBN: 978-1-5386-1488-4. DOI: 10.1109/EEM.2018.8469779. [Online]. Available: <https://ieeexplore.ieee.org/document/8469779/>.
- [190] S. X. Xu and G. Q. Huang, "Transportation service procurement in periodic sealed double auctions with stochastic demand and supply", *Transportation Research Part B: Methodological*, vol. 56, pp. 136–160, Oct. 2013, ISSN: 0191-2615. DOI: 10.1016/J.TRB.2013.07.015. [Online]. Available: <https://www.sciencedirect.com/science/article/pii/S0191261513001306>.
- [191] C. Cachin, "Architecture of the Hyperledger blockchain fabric", in *Workshop on Distributed Cryptocurrencies and Consensus Ledgers*, 2016.
- [192] "Briefing Understanding electricity markets in the EU", 2016. [Online]. Available: [http://www.europarl.europa.eu/RegData/etudes/BRIE/2016/593519/EPRS_BRI\(2016\)593519_EN.pdf](http://www.europarl.europa.eu/RegData/etudes/BRIE/2016/593519/EPRS_BRI(2016)593519_EN.pdf).
- [193] W. W. Hogan, "COMPETITIVE ELECTRICITY MARKET DESIGN: A WHOLESALE PRIMER", 1998. [Online]. Available: <https://sites.hks.harvard.edu/fs/whogan/empr1298.pdf>.
- [194] M. D. Cadwalader, S. M. Harvey, W. W. Hogan, and S. L. Pope, "COORDINATING CONGESTION RELIEF ACROSS MULTIPLE REGIONS", 1999. [Online]. Available: <https://sites.hks.harvard.edu/fs/whogan/isoc1099r.pdf>.
- [195] G. Hug-Glanzmann and G. Andersson, "Decentralized Optimal Power Flow Control for Overlapping Areas in Power Systems", *IEEE Transactions on Power Systems*, vol. 24, no. 1, pp. 327–336, Feb. 2009, ISSN: 0885-8950. DOI: 10.1109/TPWRS.2008.2006998. [Online]. Available: <http://ieeexplore.ieee.org/document/4762166/>.
- [196] S. Boyd, N. Parikh, E. Chu, B. Peleato, and J. Eckstein, "Distributed Optimization and Statistical Learning via the Alternating Direction Method of Multipliers", *Foundations and Trends® in Machine Learning*, vol. 3, no. 1, pp. 1–122, 2010, ISSN: 1935-8237. DOI: 10.1561/2200000016. [Online]. Available: <http://www.nowpublishers.com/article/Details/MAL-016>.
- [197] T. Erseghe, "A Distributed and Scalable Processing Method Based Upon ADMM", *IEEE Signal Processing Letters*, vol. 19, no. 9, pp. 563–566, Sep. 2012, ISSN: 1070-9908. DOI: 10.1109/LSP.2012.2207719. [Online]. Available: <http://ieeexplore.ieee.org/document/6236008/>.
- [198] —, "Distributed Optimal Power Flow Using ADMM", *IEEE Transactions on Power Systems*, vol. 29, no. 5, pp. 2370–2380, Sep. 2014, ISSN: 0885-8950. DOI: 10.1109/TPWRS.2014.2306495. [Online]. Available: <http://ieeexplore.ieee.org/document/6748974/>.
- [199] B. Kim and R. Baldick, "Coarse-grained distributed optimal power flow", *IEEE Transactions on Power Systems*, vol. 12, no. 2, pp. 932–939, May 1997, ISSN: 08858950. DOI: 10.1109/59.589777. [Online]. Available: <http://ieeexplore.ieee.org/document/589777/>.
- [200] G. Cohen, "Auxiliary problem principle and decomposition of optimization problems", *Journal of Optimization Theory and Applications*, vol. 32, no. 3, pp. 277–305, Nov. 1980, ISSN: 0022-3239. DOI: 10.1007/BF00934554. [Online]. Available: <http://link.springer.com/10.1007/BF00934554>.

- [201] A. Y. Lam, B. Zhang, and D. N. Tse, "Distributed algorithms for optimal power flow problem", in *2012 IEEE 51st IEEE Conference on Decision and Control (CDC)*, IEEE, Dec. 2012, pp. 430–437, ISBN: 978-1-4673-2066-5. DOI: 10.1109/CDC.2012.6427082. [Online]. Available: <http://ieeexplore.ieee.org/document/6427082/>.
- [202] J. Guo, G. Hug, and O. K. Tonguz, "A Case for Nonconvex Distributed Optimization in Large-Scale Power Systems", *IEEE Transactions on Power Systems*, vol. 32, no. 5, pp. 3842–3851, Sep. 2017, ISSN: 0885-8950. DOI: 10.1109/TPWRS.2016.2636811. [Online]. Available: <http://ieeexplore.ieee.org/document/7776940/>.
- [203] R. S. Kar, Z. Miao, M. Zhang, and L. Fan, "ADMM for nonconvex AC optimal power flow", in *2017 North American Power Symposium (NAPS)*, IEEE, Sep. 2017, pp. 1–6, ISBN: 978-1-5386-2699-3. DOI: 10.1109/NAPS.2017.8107276. [Online]. Available: <http://ieeexplore.ieee.org/document/8107276/>.
- [204] A. X. Sun, D. T. Phan, and S. Ghosh, "Fully decentralized AC optimal power flow algorithms", in *2013 IEEE Power & Energy Society General Meeting*, IEEE, 2013, pp. 1–5, ISBN: 978-1-4799-1303-9. DOI: 10.1109/PESMG.2013.6672864. [Online]. Available: <http://ieeexplore.ieee.org/document/6672864/>.
- [205] S. Magnússon, P. C. Weeraddana, and C. Fischione, "A Distributed Approach for the Optimal Power Flow Problem Based on ADMM and Sequential Convex Approximations", Jan. 2014. [Online]. Available: <http://arxiv.org/abs/1401.4621>.
- [206] E. Dall'Anese, Hao Zhu, and G. B. Giannakis, "Distributed Optimal Power Flow for Smart Microgrids", *IEEE Transactions on Smart Grid*, vol. 4, no. 3, pp. 1464–1475, Sep. 2013, ISSN: 1949-3053. DOI: 10.1109/TSG.2013.2248175. [Online]. Available: <http://ieeexplore.ieee.org/document/6502290/>.
- [207] T. Erseghe, "A distributed approach to the OPF problem", *EURASIP Journal on Advances in Signal Processing*, vol. 2015, no. 1, p. 45, Dec. 2015, ISSN: 1687-6180. DOI: 10.1186/s13634-015-0226-x. [Online]. Available: <https://asp-urasipjournals.springeropen.com/articles/10.1186/s13634-015-0226-x>.
- [208] S Boyd, N Parikh, E Chu, and B Peleato, "Distributed optimization and statistical learning via the alternating direction method of multipliers", *nowpublishers.com*, vol. 47, 2011. [Online]. Available: <http://www.nowpublishers.com/article/Details/MAL-016>.
- [209] S. P. Boyd and L. Vandenberghe, *Convex optimization*. Cambridge University Press, 2004, p. 716, ISBN: 9780521833783. [Online]. Available: https://books.google.gr/books?hl=el&lr=&id=IUzdAAAAQBAJ&oi=fnd&pg=PR11&dq=Convex+Optimization+boyd&ots=HNGGjd9JDj&sig=3T3LiuKbx2BNsIHne5S-TxQ-Ubk&redir_esc=y#v=onepage&q=Convex%20Optimization%20boyd&f=false.
- [210] E. Ghadimi, A. Teixeira, I. Shames, and M. Johansson, "Optimal parameter selection for the alternating direction method of multipliers (ADMM): quadratic problems", Jun. 2013. DOI: 10.1109/TAC.2014.2354892. [Online]. Available: <http://arxiv.org/abs/1306.2454><http://dx.doi.org/10.1109/TAC.2014.2354892>.

- [211] W. Shi, Q. Ling, K. Yuan, G. Wu, and W. Yin, "On the Linear Convergence of the ADMM in Decentralized Consensus Optimization", Jul. 2013. DOI: 10.1109/TSP.2014.2304432. [Online]. Available: <http://arxiv.org/abs/1307.5561><http://dx.doi.org/10.1109/TSP.2014.2304432>.
- [212] G. Wood, "Ethereum: A secure decentralised generalised transaction ledger. EIP-150 REVISION", 2017.
- [213] R. Lincoln, *PYPOWER: Port of MATPOWER to Python*. [Online]. Available: <https://github.com/rwl/PYPOWER>.
- [214] F. Capitanescu, M. Glavic, and L. Wehenkel, "An interior-point method based optimal power flow", 2005. [Online]. Available: https://www.researchgate.net/publication/224007182_An_interior-point_method_based_optimal_power_flow.
- [215] M. B. Maskar, A. Thorat, and I. Korachgaon, "A review on optimal power flow problem and solution methodologies", in *2017 International Conference on Data Management, Analytics and Innovation (ICDMAI)*, IEEE, Feb. 2017, pp. 64–70, ISBN: 978-1-5090-4083-4. DOI: 10.1109/ICDMAI.2017.8073487. [Online]. Available: <http://ieeexplore.ieee.org/document/8073487/>.
- [216] K. Pandya and S. Joshi, "A survey of optimal power flow methods (PDF Download Available)", [Online]. Available: https://www.researchgate.net/publication/258222948_A_survey_of_optimal_power_flow_methods.
- [217] N. Atzei, M. Bartoletti, and T. Cimoli, "A Survey of Attacks on Ethereum Smart Contracts (SoK)", in *Proceedings of the 6th International Conference on Principles of Security and Trust - Volume 10204*, Springer-Verlag New York, Inc., 2017, pp. 164–186, ISBN: 978-3-662-54454-9. DOI: 10.1007/978-3-662-54455-6{_}8. [Online]. Available: http://link.springer.com/10.1007/978-3-662-54455-6_8.
- [218] *Ethereum Network Status*. [Online]. Available: <https://ethstats.net/>.
- [219] *Ethereum Network Stats*. [Online]. Available: <https://github.com/cubedro/eth-netstats>.
- [220] *A lightweight ethereum block explorer*. [Online]. Available: <https://github.com/etherparty/explorer>.
- [221] *Ethereum Block Explorer (ETHExplorer V2) - Realtime Price Ticker, Shapeshift.io Integration, etc.* [Online]. Available: <https://github.com/carsenk/explorer>.
- [222] *Lightweight Ethereum blockchain explorer*. [Online]. Available: <https://github.com/gobitfly/etherchain-light>.
- [223] *Ethereum Blockchain Explorer*. [Online]. Available: <https://github.com/maran/ethereum-blockchain-explorer>.
- [224] *Ether Scan*. [Online]. Available: <https://etherscan.io/>.
- [225] *etherchain.org - The Ethereum Blockchain Explorer*. [Online]. Available: <https://www.etherchain.org/>.
- [226] *Homepage - QuickBlocks*. [Online]. Available: <https://quickblocks.io/>.
- [227] *A tool to monitor a number of smart contracts and transactions*. [Online]. Available: <https://github.com/Neufund/smart-contract-watch>.

- [228] *Keep Your Private Keys Close and Keep Your Smart Contracts Closer — Introducing The Smart Contract...* [Online]. Available: <https://blog.neufund.org/keep-your-private-keys-close-and-keep-your-smart-contracts-closer-introducing-the-smart-contract-e3bd1fcad204>.
- [229] *Ethereum Overview | Truffle Suite*. [Online]. Available: <http://truffleframework.com/tutorials/ethereum-overview>.
- [230] *Truffle Suite - Your Ethereum Swiss Army Knife*. [Online]. Available: <http://truffleframework.com/>.
- [231] R. J. Bessa, "Future Trends for Big Data Application in Power Systems", *Big Data Application in Power Systems*, pp. 223–242, Jan. 2018. DOI: 10.1016/B978-0-12-811968-6.00010-3. [Online]. Available: <https://www.sciencedirect.com/science/article/pii/B9780128119686000103>.
- [232] R. G. Rajasekaran, S. Manikandaraj, and R. Kamaleshwar, "Implementation of Machine Learning Algorithm for predicting user behavior and smart energy management", in *2017 International Conference on Data Management, Analytics and Innovation (ICDMAI)*, IEEE, Feb. 2017, pp. 24–30, ISBN: 978-1-5090-4083-4. DOI: 10.1109/ICDMAI.2017.8073480. [Online]. Available: <http://ieeexplore.ieee.org/document/8073480/>.