

University of Thessaly
Department of Electrical and Computer
Engineering



Diploma Thesis
Chrepas Panagiotis

“SISO-OFDM TRANSCEIVER DESIGN IN MATLAB”

“ΣΧΕΔΙΑΣΜΟΣ SISO-OFDM ΠΟΜΠΟΔΕΚΤΗ ΣΤΟ
ΠΕΡΙΒΑΛΛΟΝ ΜΑΤΛΑΒ”

Supervising Professors:

Assistant Professor, Argyriou Antonios

Assistant Professor, Athanasios Korakis

Volos 2016

ACKNOWLEDGEMENT

Initially, I would like to express my deep sense of gratitude to my thesis advisor, Assistant Professor Argyriou Antonios, for all of his assistance, guidance, dedication, constant feedback and keen interest upon completion of this thesis.

In addition, I gratefully acknowledge the contribution and help of all the Department Faculty Members throughout my study period.

Finally, I am extremely thankful to my family and friends for their unceasing encouragement and support.

ABSTRACT

The main purpose of this thesis is to present and analyze the design of a SISO-OFDM transceiver in matlab. Furthermore in this thesis we study various channel fading techniques and how they affect the bit error rate of the transmission. Ultimately we observe our simulated results and we confirm that depending on the channel fading technique used in the design the overall BER performance changes accordingly and thus it has a great effect on the quality of the transmission.

ΠΕΡΙΛΗΨΗ

Ο κύριος σκοπός αυτής της διπλωματικής εργασίας είναι η παρουσίαση και η ανάλυση της σχεδίασης ενός SISO-OFDM πομποδέκτη στο περιβάλλον MATLAB. Επιπλέον σε αυτή τη διπλωματική εργασία μελετάμε διάφορες τεχνικές διαμόρφωσης του καναλιού και το πως αυτές επηρεάζουν το ρυθμό σφάλματος των bit της μετάδοσης. Στο τέλος παρατηρούμε τα αποτελέσματα της προσομοίωσης μας και επιβεβαιώνουμε ότι ανάλογα την τεχνική διαμόρφωσης που θα χρησιμοποιήσουμε στην σχεδίαση μας η συνολική απόδοση του ρυθμού σφάλματος των bit αλλάζει ανάλογα και έτσι έχει μεγάλη επίδραση στην ποιότητα της μετάδοσης.

TABLE OF CONTENTS

1. INTRODUCTION TO OFDM MODULATION.....	1
1.1 Brief explanation	1
1.2 Ofdm usage	3
1.3 Ofdm pros/cons.....	3
2. TRANSCEIVER DESIGN.....	6
2.1 Design requirements.....	6
2.2 TRANSMITTER	9
2.2.1 Bit generation and pre-interleaving	9
2.2.2 Post-interleaving and pre-modulating.....	12
2.2.3 Post-modulating and pre-transmission.....	15
2.3 CHANNEL	17
2.4 RECEIVER.....	20
2.4.1 Post-transmission and pre-demodulation.....	20
2.4.2 Post-demodulation and preparation for the bit error rate calculation.....	23
2.4.3 Bit Error rate calculation and adaptive rate control.....	25
3. SIMULATION AND RESULTS.....	29
4. REFERENCES	33

1. INTRODUCTION TO OFDM MODULATION

1.1 Brief explanation

Orthogonal Frequency Division Multiplexing (OFDM) is a digital multi-carrier modulation scheme that extends the concept of single subcarrier modulation by using multiple subcarriers within the same single channel. Instead of transmitting a high rate stream of data within a single subcarrier it introduces a large number of closely spaced orthogonal subcarriers that are transmitted in parallel. Each subcarrier is modulated with a conventional digital modulation scheme (such as BPSK, QPSK, 16QAM, etc.) at low symbol rate, the combination of those result in data rates similar to conventional single-carrier modulation schemes within equivalent bandwidths. The main concept of OFDM includes

1. The information stream is being carried through the subcarriers that are orthogonal to each other.

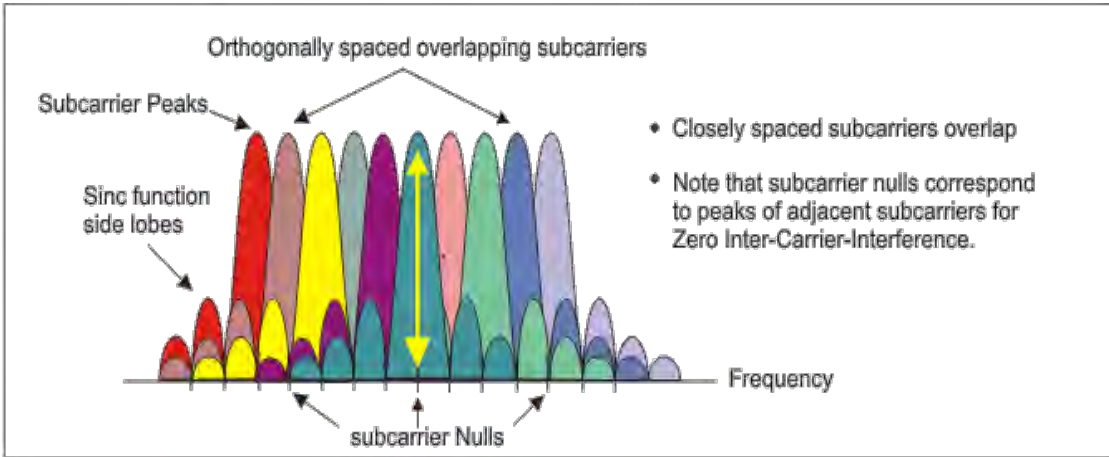

OFDM Signal Frequency Spectra

[1]

The importance of it being orthogonal is that the overlap of spectral energy does not interfere with the receiver's ability to recover the signal allowing the use of more subcarriers per bandwidth without interference between overlapping carriers, thus increasing its spectral efficiency.

- By using IFFT the subcarriers are turned into an OFDM waveform. Appending a guard interval to this waveform results in creating the ofdm symbol and minimizing the channel delay spread and ISI between the symbols. Finally through one OFDM burst we transmit one or more OFDM symbols.

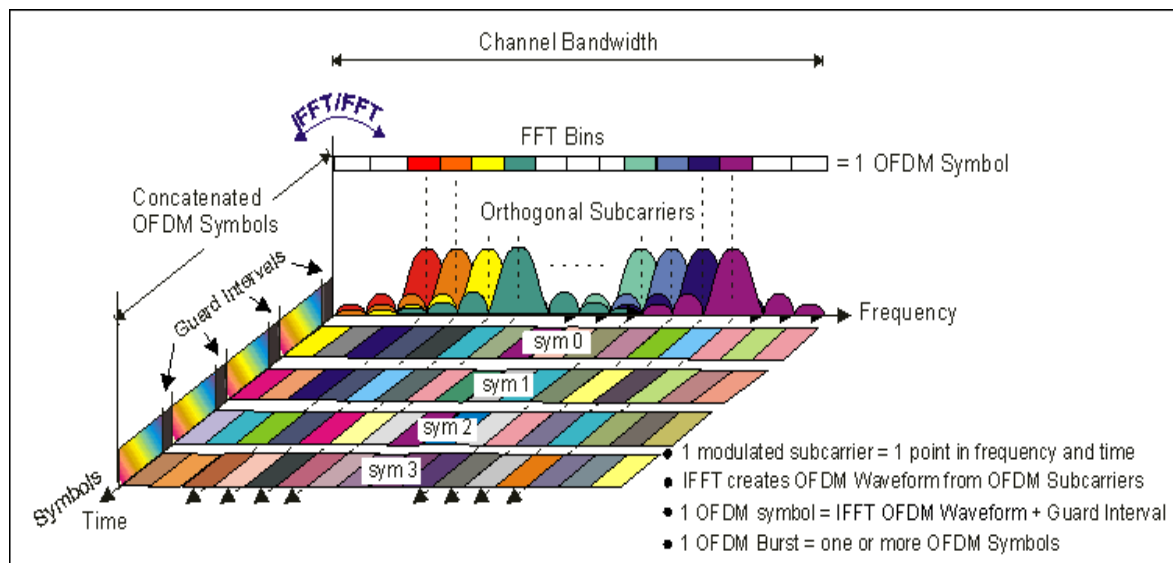

Frequency-Time Representative of an OFDM signal

[1]

- The receiver at the other hand, simply uses FFT on the OFDM symbols that it received and recover the information stream properly.

1.2 Ofdm usage

OFDM is widely used in a large variety of applications. Its ability to cope with severe channel conditions such as attenuation of high frequencies in copper wires as well as narrowband interference and frequency-selective fading due to multipath without using complex equalization filters enabled it to be used in the latest wireless and telecommunications standards. Some worth mentioning examples in cabled telecommunication are ADSL and VDSL broadband access via POTS copper wiring, DVB-C2 digital cable TV standard Multimedia Over Coax Alliance (MOCA) home networking. As for wireless telecommunication it is being used in many IEEE standards like 802.11a, 802.11n, 802.11ac, 802.16d etc. It has also been chosen for the cellular telecommunications standard LTE / LTE-A, and in addition to this it has been adopted by other standards such as WiMAX and more.

1.3 Ofdm pros/cons

The OFDM modulation technique's main property, the use of multiple orthogonal subcarriers within the same single channel and its ability to distinct them at the decode process is what it makes it unique. The main advantages of this technique will be further explained.

- ***Immunity to selective fading:*** It is more resistant to frequency selective fading than single carrier systems because it divides the overall channel into multiple narrowband signals that are affected individually as flat fading sub-channels.

- **Resilience to interference:** Interference appearing on a channel may be bandwidth limited and in this way will not affect all the sub-channels. This means that not all the data is lost.
- **Spectral efficiency:** Using close-spaced overlapping sub-carriers, a significant OFDM advantage is that it makes efficient use of the available spectrum.
- **Resilient to ISI:** Another advantage of OFDM is that it is very resilient to inter-symbol and inter-frame interference. This results from the low data rate on each of the sub-channels.
- **Resilient to narrow-band effects:** Using adequate channel coding and interleaving it is possible to recover symbols lost due to the frequency selectivity of the channel and narrow band interference. Not all the data is lost.
- **Simpler channel equalization:** One of the issues with CDMA systems was the complexity of the channel equalization which had to be applied across the whole channel. An advantage of OFDM is that using multiple sub-channels, the channel equalization becomes much simpler.

As advantageous as OFDM may be it has its drawbacks that can be specified as

- **High peak to average power ratio:** An OFDM signal has a noise like amplitude variation and has a relatively high large dynamic range, or peak to average power ratio. This impacts the RF amplifier efficiency as the amplifiers need to be linear and accommodate the large amplitude variations and these factors mean the amplifier cannot operate with a high efficiency level.

- ***Sensitive to carrier offset and drift:*** Another disadvantage of OFDM is that it is sensitive to carrier frequency offset and drift. Single carrier systems are less sensitive.
- ***Sensitive to Doppler shift:*** In addition to the disadvantages mentioned, Doppler shift should be properly set in order to avoid the ICI between subcarriers. Too high or too low values can inflict ICI at the receiver.
- ***Loss of efficiency:*** Furthermore one disadvantage that we need to refer to is that the guard interval between OFDM symbols is usually kept large enough to tolerate worst case channel delay spread conditions, which in turn causes loss in efficiency of the system.

[2]

2. TRANSCEIVER DESIGN

2.1 Design requirements

As for the main topic of this thesis, the transceiver design, it is of utmost importance to define the requirements our design must meet in order to fully understand all of its concept. It is also really important to mention that most of the variables set and used are defined by these requirements. The transceiver design which will be described and analyzed in this thesis is built to meet most of the standards of IEEE 802.16d and IEEE 802.16-2004. Many of the variables that were used derive from the standards above.

In order to fully understand what will be further explained let's see how an OFDM symbols is structured in the frequency domain

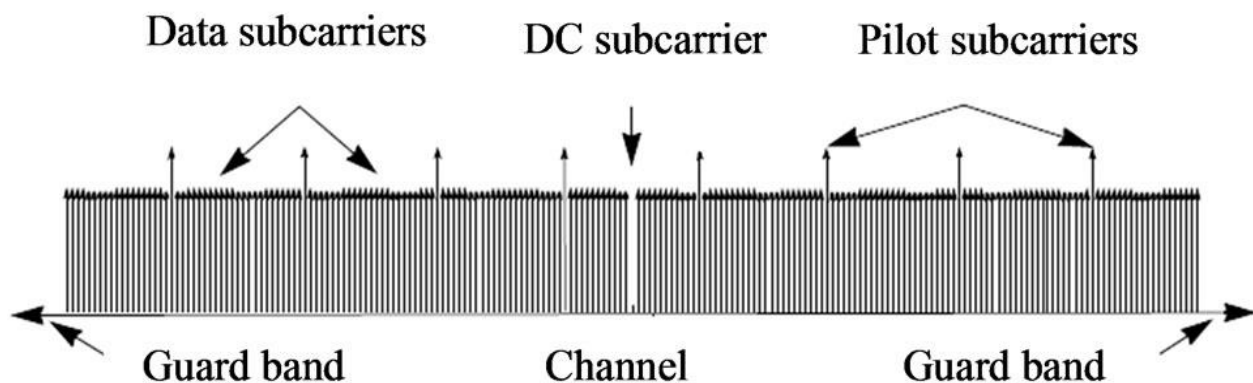

[3]

- **Data subcarriers:** The data subcarriers are the subcarriers who carry the bit of the information we want to transmit hence they are used for the transmission
- **DC subcarrier:** The DC subcarrier belongs to the so called Null subcarriers and it is not being used for the transmission

- **Pilot subcarriers:** The pilot subcarriers are used for estimation processes in the FFT.
- **Guard band:** The guard band is being created by the Cyclic Prefix, and it helps the signal to naturally decay in order to preserve the orthogonal property of the sub-channel.

The sum of all these subcarriers define the size of the FFT we need to use.

Another set of variables we need to explain before we proceed are the following:

- **BW:** The channel bandwidth
- N_{used} : The number of used subcarriers
- n : The sampling factor that determines the subcarrier spacing and the useful symbol time
- G : The ratio of Cyclic Prefix time to “useful” time
- N_{FFT} : The size of the FFT used
- F_S : The sampling frequency, and it is computed by this equation : $F_S = \text{floor}(n * BW / 8000) * 8000$
- T_S : The sampling time, and it is computed by this equation : $T_S = T_b / N_{FFT}$
- Δ_f : The subcarrier spacing, the frequency between two adjacent “peaks” of two adjacent subcarriers, helps defeating ICI and it is computed by this equation : $\Delta_f = F_S / N_{FFT}$
- T_b : The useful symbol time duration, and it is computed by this equation : $T_b = 1 / \Delta_f$
- T_g : The Cyclic Prefix time, determines the frequency guard band, helps defeating ISI and it is computed by this equation : $T_g = G * T_b$

- T_s : The OFDM symbol time, and it is computed by this equation : $T_s = T_b + T_g$
- **Data Rate**: The data rate of the transmission emanates from: $Data\ rate = Bits_{per\ subcarrier} * N_{inform\ subcarrier} * Coderate / T_s$
- **Bit Rate**: The bit rate of the transmission emerges from: $Bit\ rate = Bits_{per\ subcarrier} * N_{used} * Coderate / T_s$

Finally in our case these equations are formed through this table which is defined by the standards of IEEE 802.16-2004.

Parameter	Value
N_{FFT}	256
N_{used}	200
n	For channel bandwidths that are a multiple of 1.75 MHz then $n = 8/7$ else for channel bandwidths that are a multiple of 1.5 MHz then $n = 86/75$ else for channel bandwidths that are a multiple of 1.25 MHz then $n = 144/125$ else for channel bandwidths that are a multiple of 2.75 MHz then $n = 316/275$ else for channel bandwidths that are a multiple of 2.0 MHz then $n = 57/50$ else for channel bandwidths not otherwise specified then $n = 8/7$
G	1/4, 1/8, 1/16, 1/32
Number of lower frequency guard subcarriers	28
Number of higher frequency guard subcarriers	27

[3]

IMPORTANT NOTICE: Due to the fact that the design is fully customizable the main functionality of the Simulink blocks will be explained below. Arithmetic and other values which derive from the design and any other design-built parameters will not be explained due to the user customization choice.

2.2 TRANSMITTER

It would be wise to divide the transmitter design into three sub-designs so that the design comprehension will be much easier to be achieved.

2.2.1 Bit generation and pre-interleaving

For starters, we need to generate the bit stream we want to transmit. For that job a simple Bernoulli Binary Generator with a 0.5 percent probability of zero will do the trick

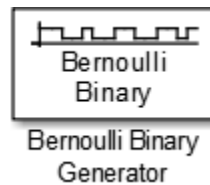

Now, the output signal of this block is going through two padding blocks one for the bit we need to select, and the other for zero padding of the tail byte of the bits we selected. The size of the output vector of the first padding block depends on the number of ofdm symbols per transmission burst.

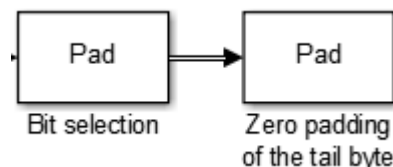

To continue with, the output signal of this block needs to be convolutionally encoded before entering the interleaving block. By the standards of IEEE 802.16d and IEEE 802.16-2004 the supported modulation techniques and code rates are as

mentioned: BPSK $\frac{1}{2}$, QPSK $\frac{1}{2}$, QPSK $\frac{3}{4}$, 16QAM $\frac{1}{2}$, 16QAM $\frac{3}{4}$, 64QAM $\frac{2}{3}$, 64QAM $\frac{3}{4}$.

Convolutional encoding involves the creation of an error correcting code type that generates parity symbols via the sliding application of a Boolean polynomial function to a data stream. The sliding application represents the convolution of the encoder over the data and the sliding nature facilitates the convolutional encoder, a Finite State Machine known as trellis. A path on the diagram that represents this trellis is an actual encoded sequence. [5]

As for the simple case of BPSK $\frac{1}{2}$, convolutional encoding can be achieved with just this one block.

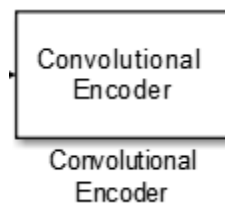

However for the other types of the modulation techniques and code rates that are supported we need punctured convolutional and Reed Solomon encoding. Puncturing is a technique that allows the encoding and decoding of higher rate codes using standard rate $\frac{1}{2}$ encoders and decoders.

The Reed Solomon encoding results in correcting both errors and erasures. Erasures occur when a receiver identifies the most unreliable symbols in a given codeword. After the identification they are replaced by a zero and the receiver indicates the decoder with a flag that it is an erasure and not a valid symbol.

In addition to form a punctured Reed Solomon encoder, the encoder always needs to remove specific parity symbols from its output. Thus creating puncture patterns which are treated by the decoder as receiver-generated erasures. [10]

A punctured Reed Solomon encoder can be formed through these blocks:

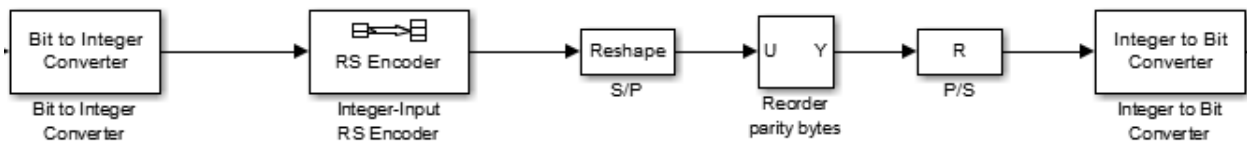

Regarding the punctured convolutional encoding, the same block can be used as before by enabling the puncture code option that the block offers. [11]

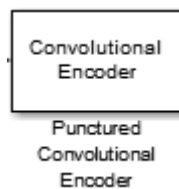

Finally after passing through the convolutional encoder the signal enters the interleaving phase.

Interleaving is a technique that is being used for improving error correcting codes. To be more precise interleaving enhances the decoder's ability to identify burst errors that occur in the transmission. It does so by taking a block of bits and interleaving it in a particular known order. Hence, when a burst error occurs, after de-interleaving it at the receiver the affected bits are more spread apart than the original burst making them much easier to detect. [7]

Interleaving can be accomplished by the following block, which is linked to a matlab function that computes the permutation vector according to IEEE 802.16d and IEEE 802.16-2004 standards.

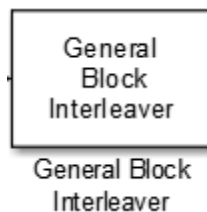

2.2.2 Post-interleaving and pre-modulating

To continue with the design of the transmitter, the signal after the interleaving block it needs to be modulated. Thus for each supported modulating technique and coderate it passes through the BPSK QPSK 16QAM and 64QAM blocks respectively.



So after being modulated the signal output of all these blocks goes through a merge block which merges all the outputs of the modulation bank into a single one. The output of this block then comes through a reshape block for the proper serial to parallel conversion containing the ofdm data carriers and the total ofdm symbols number in tis rows and its columns respectively.

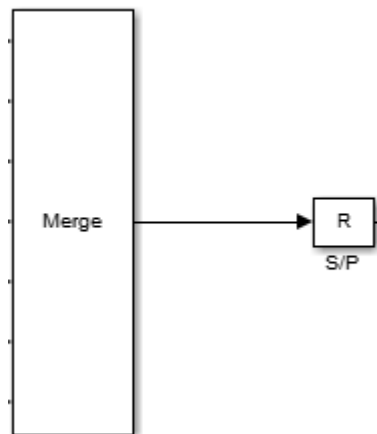

(1)

Now the signal is ready to go through the ofdm modulation block and enter the ofdm modulation phase.

The ofdm modulation phase consists of three main steps

1. We need to integrate the pilots and the data subcarriers into a single signal
2. This signal needs an Inverse Fast Fourier Transformation. This transformation is needed because its execution time is what creates the subcarrier spacing in the frequency domain that maintains the ofdm orthogonal property and preventing the Inter Carrier Interference.
3. After the Inverse Fast Fourier Transformation the cyclic prefix must be added in order to maintain the orthogonal property of the ofdm modulation due to multipath environments. The cyclic prefix is the prefixing of a symbol with a repetition of the end. By adding it we create the guard interval needed to combat Inter Symbolic Interference.

The other thing we need though is to properly prepare the pilots for the ofdm modulation. Due to customization properties the pilot creation depends and alters on the user ofdm parameterization setup so a sequence generator along with these blocks are needed in order to properly create the pilots depending on the user choice. The values and indices of the pilot are defined by IEEE 802.16d and IEEE 802.16-2004 standards.

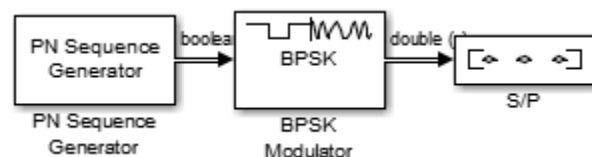

We also need to concatenate them into a single signal in order to become the other input the ofdm modulation block needs, besides the information subcarrier signal.



(2)

Finally the output signals of (1), (2) are the top down input signals of the following ofdm modulation block.

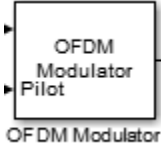

2.2.3 Post-modulating and pre-transmission

Lastly, after the signal gets modulated in order to be transmitted we need to prepend on it a preamble ofdm symbol. The preamble symbol is needed for the identification of the ofdm symbol by the receiver and it is also being used for channel estimation purposes. Hence the final structure of the ofdm symbol with the preamble insertion according to IEEE 802.16d and IEEE 802.16-2004 standards is the following.

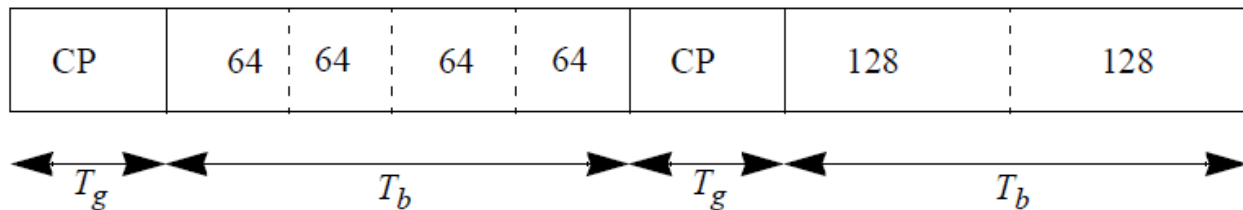

Figure 205—Downlink and network entry preamble structure

[3]

The preamble entail sending a certain number of training symbols prior to the user data symbols. These training signal are being sent independently from two antennas using one antenna at a time while the other one being silent. In this way the receiver estimates the channel and identifies properly the ofdm symbol sent. The fact that we only use the preamble for the channel estimation and not the pilot subcarriers is leading to the hypothesis that the channel is being constant for the number of the ofdm symbols sent during a burst. We also use a short preamble for every downlink burst, so it is important to mention the fact that perfect synchronization between transmitter and receiver is also being assumed.

[8]

The blocks which are needed to concatenate the ofdm signal together with the preamble one are the following.

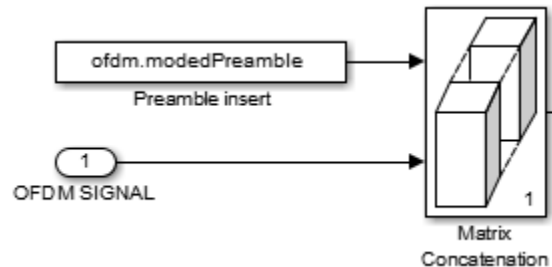

The training process as well as preamble creation are being defined by the IEEE 802.16d and IEEE 802.16-2004 standards. The initialization and the creation of the preamble is taking place at the start of the simulation depending on the user customization choice.

Finally before entering the channel the signal needs to be properly power amplified in order to be transmitted.

The following block does the job

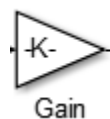

The values for the amplification gain also vary due to the user customization choice.

Depending on the fading selection value the channel can be formed as one of the following types which will be explained further below:

1. A no fading channel
2. A flat fading channel
3. A frequency selective fading channel

For all the types of the supported channels we use the same Additive White Gaussian Noise creation from variance as the processing mode in the awgn block. This noise variance is being created through some mathematical functions behind the mask of the noise variance block that we see below.

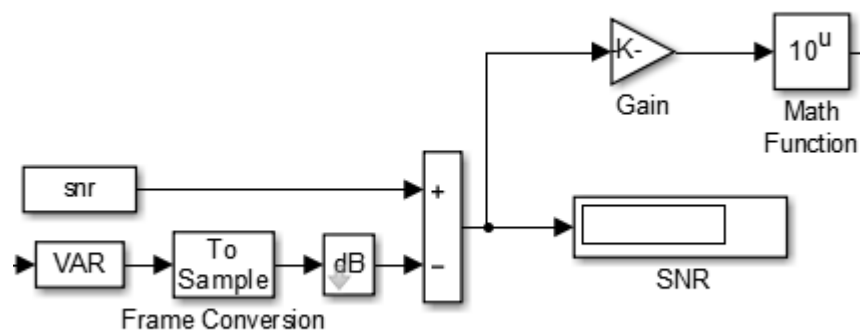

The SNR the user selects is being used here in order to create the noise variance before entering the awgn block.

After the creation of the variance of the signal's noise and the fading selection, the signal and its noise enter the awgn block where the transmission signal and the noise merge into a single signal. The output of this block is being handled by the receiver

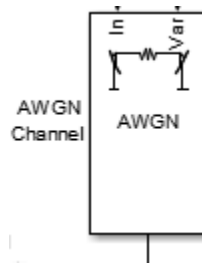

The no fading channel selection implies that the signal is getting through the multipoint switch without entering any of the multipath fading Rayleigh channels, so only the noise is added to the signal. The Bit Error Rate that this channel provides is the worst in contrary with the other two types of the channel because the signal is not being processed at all before the noise affects it.

As for the flat fading channel selection the signal is being affected by the Doppler shift in order to create the fading and since the coherence bandwidth of the channel is larger than the bandwidth of the signal all frequency components of the signal will experience the same magnitude of fading. After the fading it enters the awgn block and the noise is added to the signal. This channel type provides better BER than the no fading channel yet worse than the frequency selective fading type. [6]

To conclude with the channel fading selection the most complicated and most BER beneficial channel type among these three types is the frequency selective fading type. That happens due to the fact that the coherence bandwidth of the channel is smaller than the bandwidth of the signal, so different frequency components of the signal experience uncorrelated fading. The discrete path delay vectors and the average path gain per vector are computed through the Non Line Of Sight (NOLOS) model. [4]

2.4 RECEIVER

The division of the receiver's design into sub-designs will also help making the receiver's comprehension achievable.

2.4.1 Post-transmission and pre-demodulation

After the signal has been transmitted it needs to be properly handled by the receiver. Firstly it needs to be properly power amplified and then properly ofdm demodulated. The following two blocks will do the job.

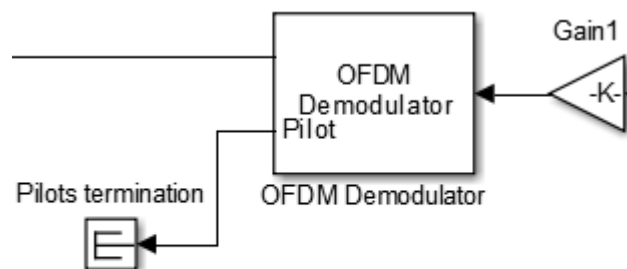

At first the signal is passing through the receiver gain block and then it gets properly demodulated. It also discards the pilot subcarriers that will be no longer needed for the further digital demodulation.

The ofdm demodulator block parameter setup depends on the transmitter's parameter setup and it does the reverse modulation thus having the preamble and the information symbols united in a single signal.

As for the gain block the receiver's gain value is the exact reverse of the transmitter's value so that the power can be equalized.

In order to continue, the signal containing the preamble and the information symbol needs to be properly handled so that the channel estimation can be achieved.

For starters let's see how the signal can be prepared along with the training preamble for the channel estimation process.

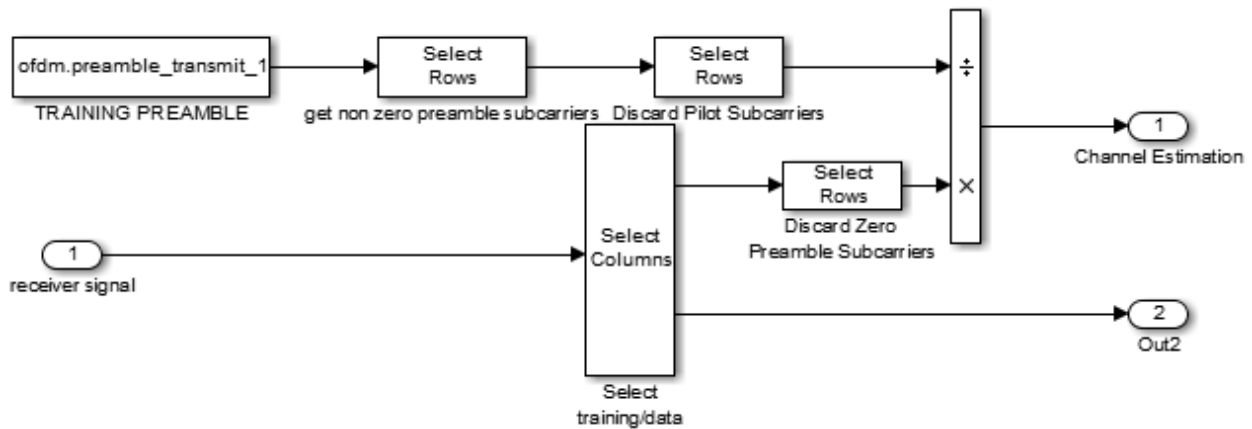

Continuing with the information signal's path the signal needs to get distinguished between the training symbol and the information symbol. Then the training preamble and the preamble symbol we got from separating the signal is used for the channel estimation process. Afterwards some mathematical processes are needed in order to compute the gain for each ofdm symbol transmitted.

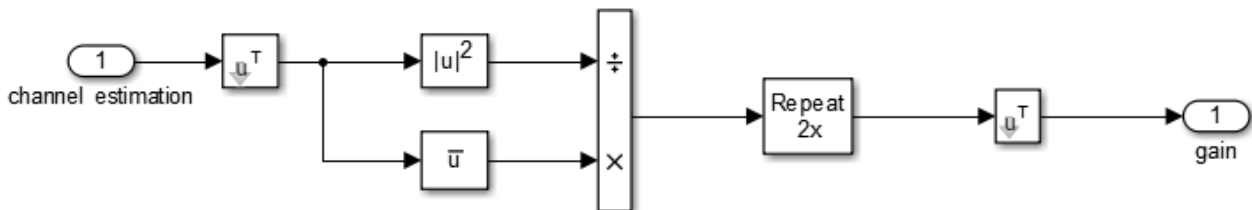

Finally we need to multiply the channel estimation gains with the information signal we separated before in order to remove the ISI the channel distortion evoked.

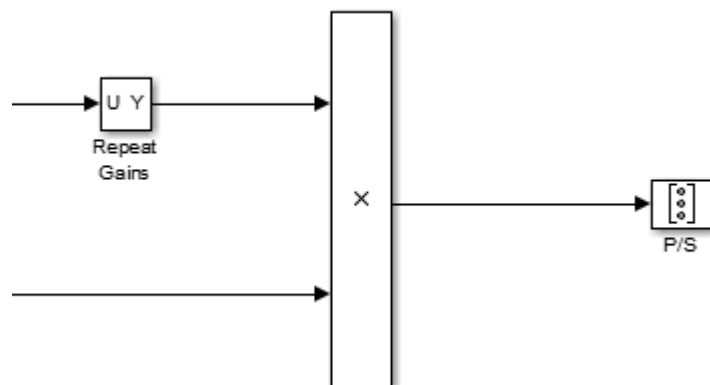

Now the information signal is ready for the final digital demodulation and then the bit error rate calculation.

2.4.2 Post-demodulation and preparation for the bit error rate calculation

Proceeding with the information signal's path it needs to get digitally demodulated in order to reach the bit error rate calculation phase. So it enters the demodulation bank and depending the type of the modulation and the coderate it gets demodulated respectively.

Concerning the simple case of BPSK $\frac{1}{2}$, the blocks need for the demodulation process are the following.

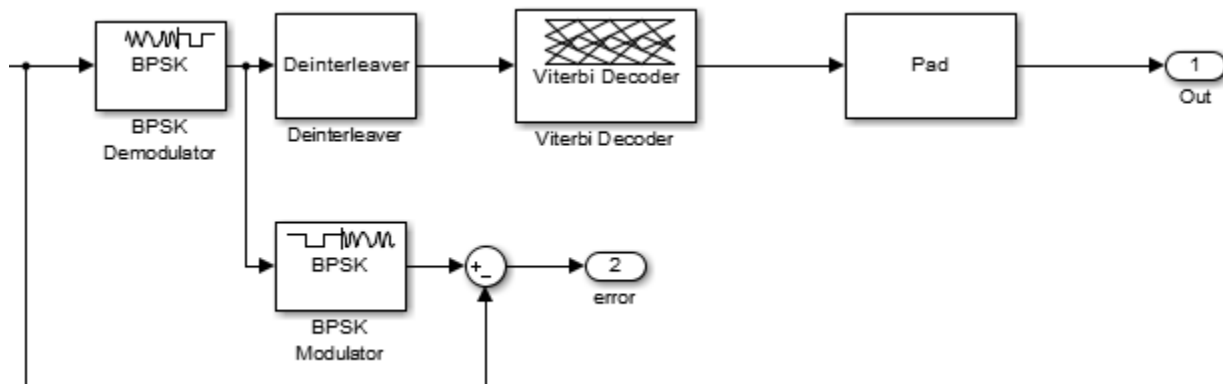

The BPSK demodulator block does the demodulation process for the BPSK modulation scheme.

As for the de-interleaver block, it consists of the following block and does the reverse interleaving procedure with the same interleaving function embedded in the transmitter's block.

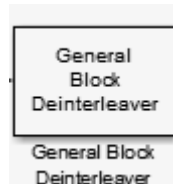

The Viterbi decoder block is being used in order to decode the convolutional encoded bit stream through the Viterbi' algorithm. It also allows punctured convolutional code decoding within its parameter setup.

The pad block is being used for zero padding depending on the bits that are in excess.

The BPSK modulator block and depending the modulation scheme supported each modulation block placed there, will be used for the bit error rate control later and they will be further explained below.

The same blocks are used for the other supported digital modulations and code rates except the fact that the need to decode punctured convolutional encoded code. The following series of blocks do the punctured Reed Solomon decoding.

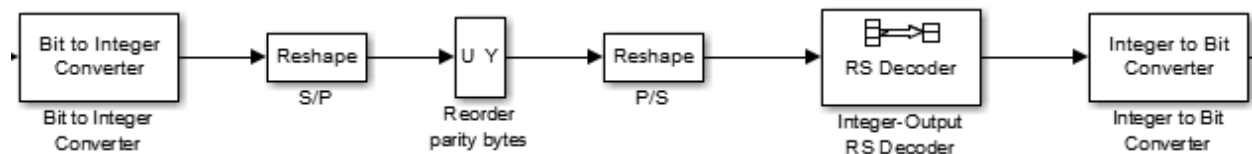

After the punctured Reed Solomon decoding takes place the signal is getting through the Viterbi's decoder block like before, being configured in such way to handle punctured convolutional encoded code. The parameter setup for the decode process is the same as the one at the encode process.

To conclude with the preparation for the bit error rate calculation the signal depending on the rate_id value which will be explained below comes through a multiport switch and it goes to the bit error rate calculation block.

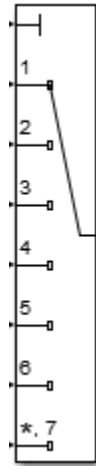

2.4.3 Bit Error rate calculation and adaptive rate control

Finally it is about time to describe how the bit error rate selection and the BER calculation takes place.

It would be wise to start with the adaptive rate control design as it is the one which the BER calculation depends on. The output of this subsystem design is the rate_id value which is the value that the design checks in order to choose the most beneficial modulation and demodulation scheme according to the estimated SNR computed.

The output of the modulator block depending on the modulation scheme and so the rate_id at the demodulation bank we have met earlier meets this tag.

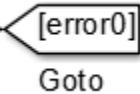

This tag is a goto tag that is connected to a from tag which the signal is being led to, and depending the rate_id it comes to a multiport switch before being used as the input of the adaptive rate control subsystem.

The modulated signal that comes with the error meets afterwards the from tag which the error tag is connected to and depending the rate_id it gets through a multiport switch.

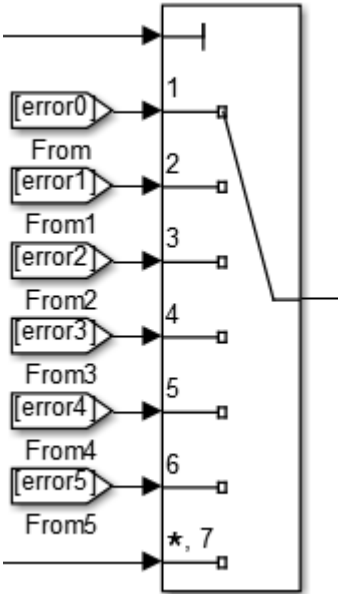

To continue, the output of the multiport switch is the input of the adaptive rate control subsystem.

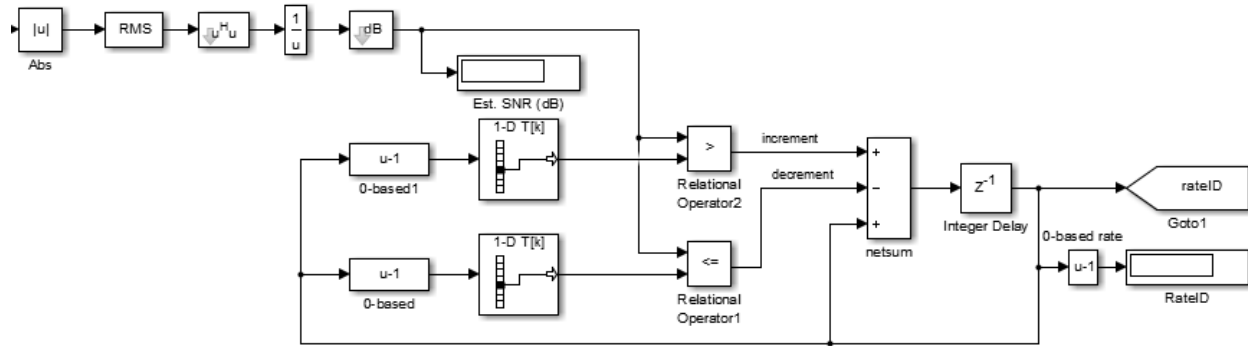

The functionality of this subsystem is first to compute the estimated SNR in dB and then to compare it with a standard threshold in order to compute the rate_id. Then it feeds back the signal to the modulation and demodulation banks as well as the bit error selection input through from tags.

To advance with the bit error rate selection we need to show how the bit error selection is taking place.

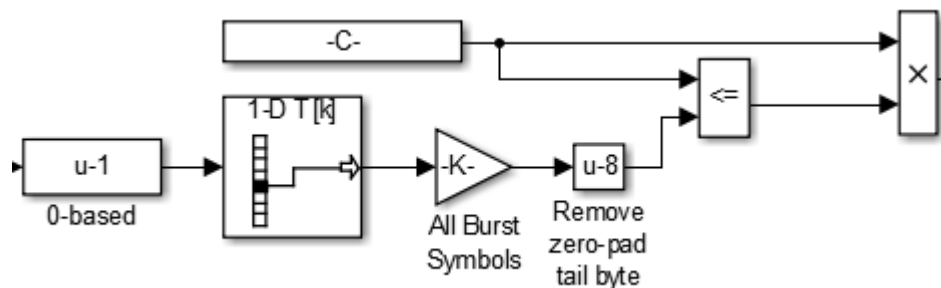

The signal which comes from the goto tag gets compared with a signal which contains the max bits the transmission supports according to the user choice. Afterwards it gets multiplied with the signal from the input in order to create the samples needed for the bit error rate calculation.

Finally the bit error rate calculation block is the following

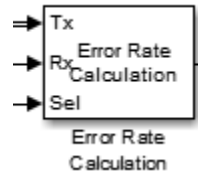

The Tx input refers to the transmitter input and comes directly from the Bernoulli Binary Generator at the start of the design.

The Rx input on the other hand is the input that is being driven from the receiver after it got through the multiport switch.

The Sel input is the input which drives the samples which are being used for the bit error rate calculation we described just above.

Thus the Bit Error Rate calculation takes place and the quality of the transmission can be demonstrated.

3. SIMULATION AND RESULTS

To conclude, the quality of the transmission can be manifested through a simulation test.

The main simulation test parameters that are also user customizable are the following.

Channel Bandwidth (BW) = 3.5 MHz

Cyclic Prefix Factor (G) = 1/8

OFDM Symbols per burst = 1

Simulation start time = 0 sec

Simulation stop time = 100 msec

Channel type = Frequency selective fading type

The rest can be deduced by the above and by the IEEE 802.16d and IEEE 802.16-2004 standards.

Initially, the transmitter's spectrum is the following.

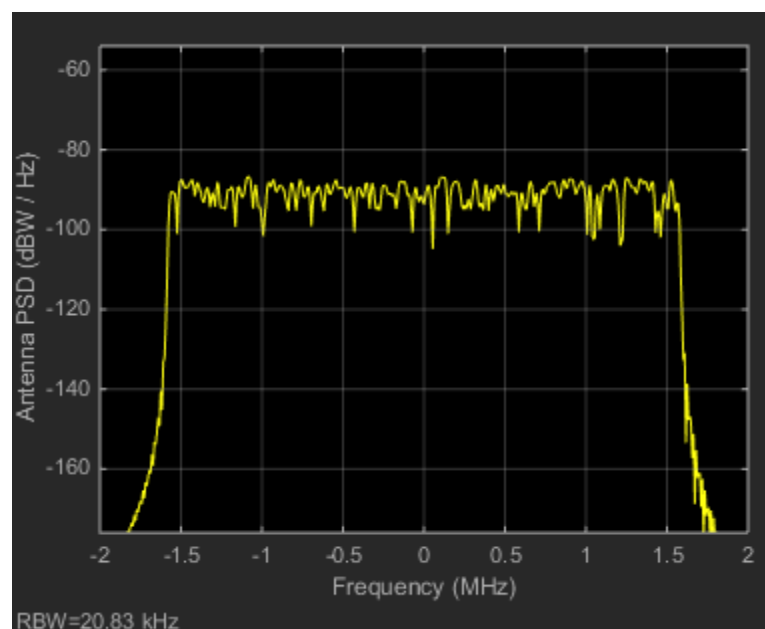

By carefully selecting the subcarrier spacing, the OFDM signal spectrum can be made flat and the orthogonal property among the sub channels can be guaranteed. Center frequency is at 0 MHz.

Furthermore, the channel spectrum and the AWGN noise affecting it can be deduced from the following graphs. Both graphs entail a Doppler shift frequency of 200 Hz.

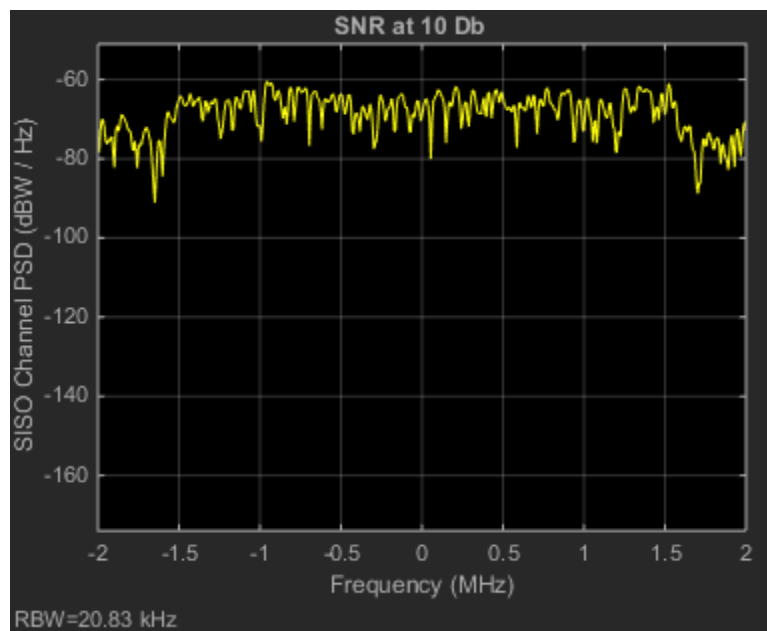

Increasing the SNR (Db) the difference can be noted.

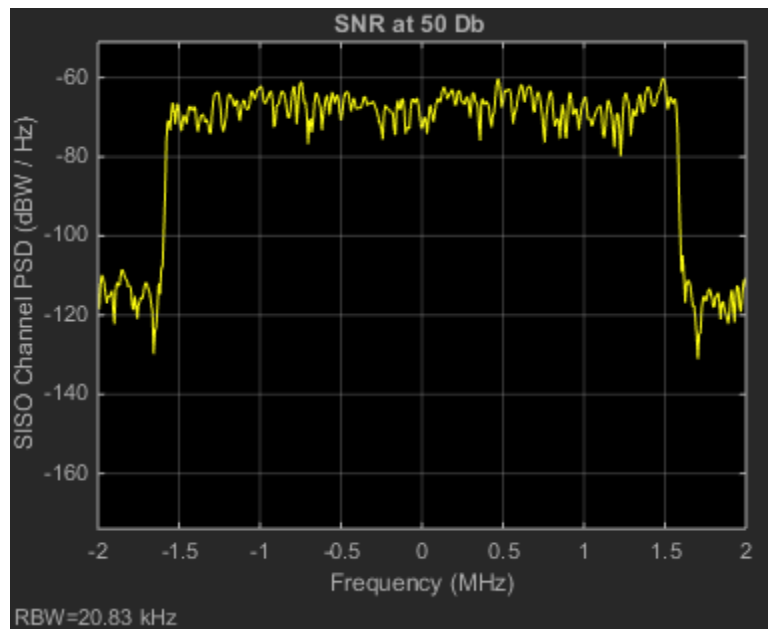

Moreover, through a receiver constellation diagram the AWGN that occurs and disappears depending on the SNR (Db) value can be also represented.

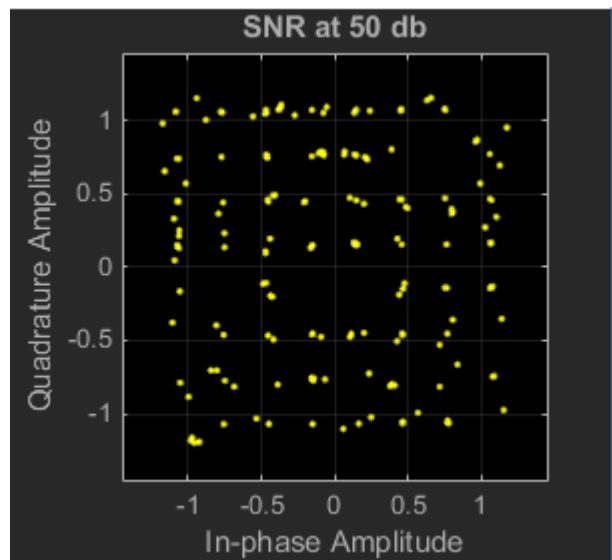
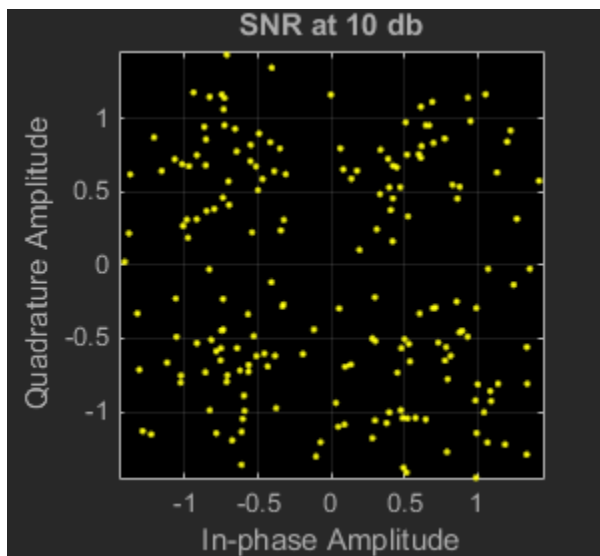

Ultimately, the final graph representing the BER values and the quality of the transmission for each channel type is the following.

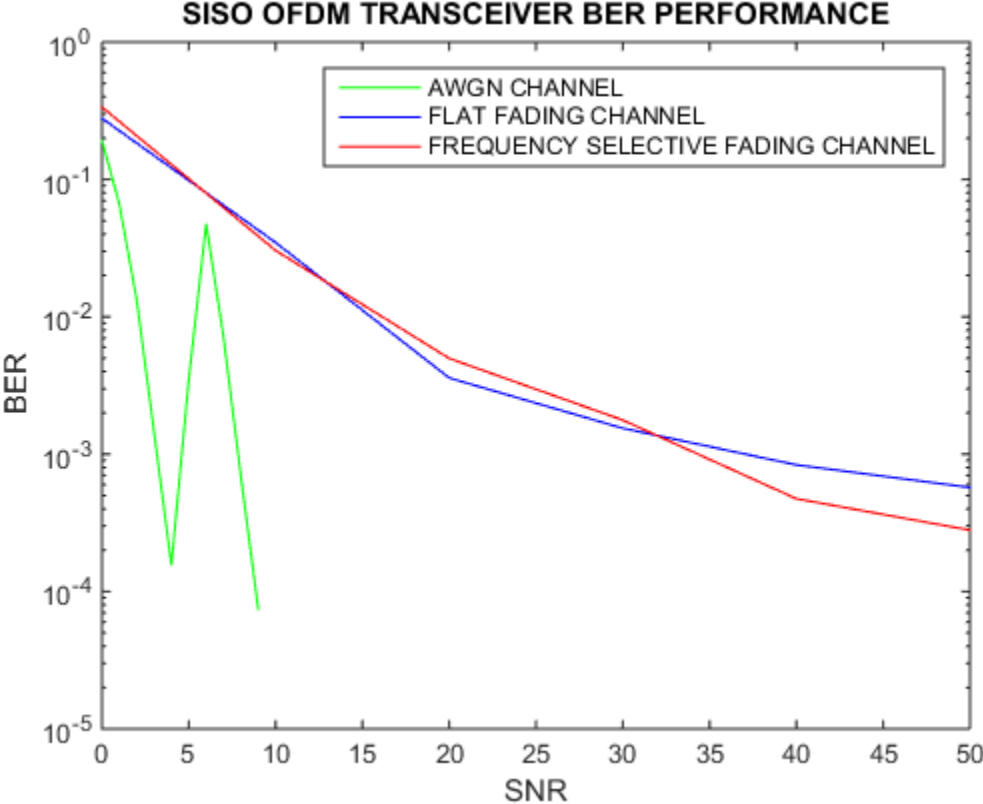

It can be deduced that depending on the fading channel type the quality of the transmission can really differ so the channel should be really carefully analyzed and evaluated before being used in any simulated or actual transmission design.

4. REFERENCES

[1] K. Technologies, "Concepts of Orthogonal frequency division multiplexing (OFDM) and 802.11 WLAN," 2000. [Online].

Available:

http://rfmw.em.keysight.com/wireless/helpfiles/89600b/webhelp/su_bsystems/wlan-ofdm/Content/ofdm_basicprinciplesoverview.htm.

Accessed: May 5, 2016.

[2] I. Poole, "Orthogonal frequency division multiplexing,"

Google+. [Online]. Available: <http://www.radio-electronics.com/info/rf-technology-design/ofdm/ofdm-basics-tutorial.php>. Accessed: May 5, 2016.

[3] *IEEE standard for local and metropolitan area networks*. New York: Institute of Electrical and Electronics Engineers, 2004.

[4] R. Cristi, *Wireless Communications with Matlab and Simulink: IEEE802.16 (WiMax) Physical Layer*. 2009.

[5] "Convolutional code," in *Wikipedia*, Wikimedia Foundation, 2016. [Online]. Available:

https://en.wikipedia.org/wiki/Convolutional_code#Trellis_diagram.

Accessed: May 5, 2016.

[6] "Fading," in *Wikipedia*, Wikimedia Foundation, 2016. [Online].

Available: https://en.wikipedia.org/wiki/Fading#Selective_fading.

Accessed: May 5, 2016.

[7] F. H. Gregorio, *802.11A - OFDM PHY CODING AND INTERLEAVING*. FIN-02015 HUT, Finland.

- [8] TELETOPIX, "Ways to transmit training symbols: Preamble or pilot tones in Wimax," 2016. [Online]. Available: <http://www.teletopix.org/wimax/ways-to-transmit-training-symbols-preamble-or-pilot-tones-in-wimax/>. Accessed: May 5, 2016
- [9] S. S. Das, F. H. P. Fitzek, E. D. Carvalho, and R. Prasad, *Variable Guard Interval Orthogonal Frequency Division Multiplexing in presence of Carrier Frequency Offset*. Tata Consultancy Services, India.
- [10] T. MathWorks, "Punctured Convolutional coding," 1994. [Online]. Available: <http://www.mathworks.com/help/comm/ug/punctured-convolutional-coding-1.html>. Accessed: May 5, 2016.
- [11] T. MathWorks, "Reed-Solomon coding with erasures, Punctures, and shortening," 1994. [Online]. Available: <http://www.mathworks.com/help/comm/ug/reed-solomon-coding-with-erasures-punctures-and-shortening.html?requestedDomain=www.mathworks.com>. Accessed: May 5, 2016.
- [12] "Orthogonal frequency-division multiplexing," in *Wikipedia*, Wikimedia Foundation, 2016. [Online]. Available: https://en.wikipedia.org/wiki/Orthogonal_frequency-division_multiplexing#Usage. Accessed: May 17, 2016.
- [13] T. MathWorks, "IEEE® 802.16-2004 OFDM PHY link, including space-time block coding," 1994. [Online]. Available: <http://www.mathworks.com/help/comm/examples/ieee-802-16-2004-ofdm-phy-link-including-space-time-block-coding.html>. Accessed: May 5, 2016.