



UNIVERSITY OF THESSALY

Department of Biochemistry & Biotechnology

Styliani Georgiou

Doctoral thesis

**Expression of skeletal myosin light chain 2  
in gilthead sea bream (*Sparus aurata, L*):  
regulation and correlation to growth markers**

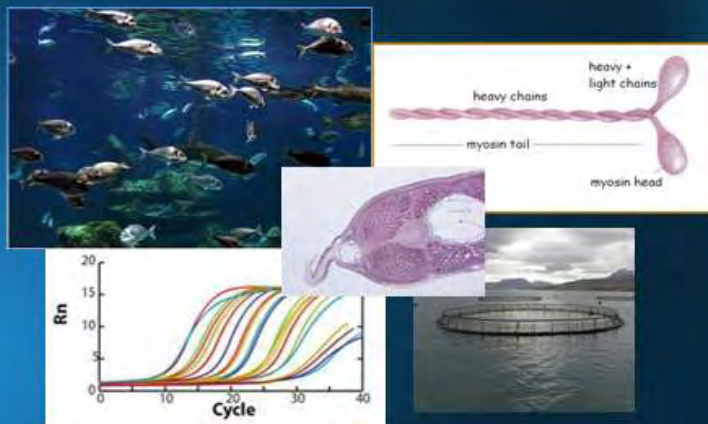

Larissa 2013

This research has been co-financed by the European Union (European Social Fund – ESF) and Greek national funds through the Operational Program "Education and Lifelong Learning" of the National Strategic Reference Framework (NSRF) - Research Funding Program: Heracleitus II. Investing in knowledge society through the European Social Fund.

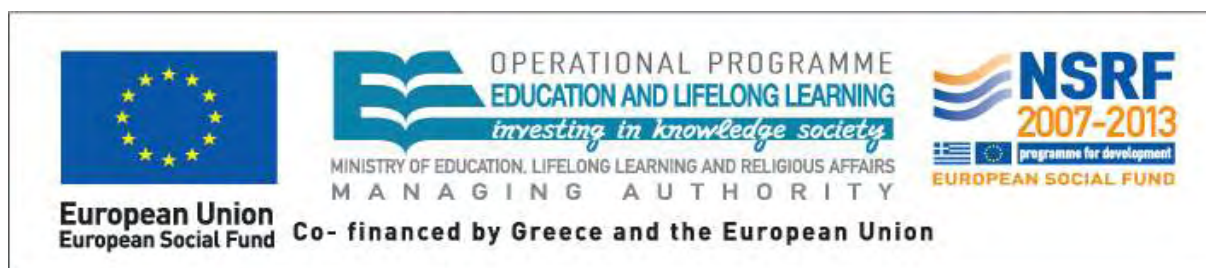

## **Expression of skeletal myosin light chain 2 in gilthead sea bream**

**(*Sparus aurata*, L): regulation and correlation to growth markers**

### **Three-member committee:**

- **Katerina Moutou (supervisor):** Associate Professor in Vertebrate Biology, Department of Biochemistry & Biotechnology, University of Thessaly, Greece
- **Zissis Mamuris:** Professor in Animal Population Genetics, Department of Biochemistry & Biotechnology, University of Thessaly, Greece
- **Deborah M. Power:** Professor in Biotechnology, University of Algarve, Portugal

### **Seven-member committee:**

- **Katerina Moutou:** Associate Professor in Vertebrate Biology, Department of Biochemistry & Biotechnology, University of Thessaly, Greece
- **Zissis Mamuris:** Professor in Animal Population Genetics, Department of Biochemistry & Biotechnology, University of Thessaly, Greece
- **Deborah M. Power:** Professor in Biotechnology, University of Algarve, Portugal
- **Elena Sarropoulou:** Researcher C grade in Hellenic Center Marine Research, Crete, Greece
- **Konstantinos Mathiopoulos:** Professor in Molecular Biology, Department of Biochemistry & Biotechnology, University of Thessaly, Greece
- **Efthimia Antonopoulou:** Assistant Professor in Fish Physiology, Department of Zoology, Faculty of Science, Aristotle University, Greece
- **Georgios Koumoundouros:** Associate Professor in Marine Biology, Biology Department, University of Crete, Greece

**Expression of skeletal myosin light chain 2  
in gilthead sea bream (*Sparus aurata*, L):  
regulation and correlation to growth markers**

Styliani Georgiou

Styliani Georgiou

2013

**Expression of skeletal myosin light chain 2 in gilthead sea bream (*Sparus aurata, L*): regulation and correlation to growth markers**

Doctoral thesis

University of Thessaly

**Present doctoral thesis in numbers:**

- Number of preliminary pages: XVIII
- Number of total pages: 203
- Number of figures: 36
- Number of tables: 11
- Number of references: 366

V

## ***Publications***

**Georgiou, S.**, Alami-Durante, H., Cluzeaud, M., Bazin, D., Power, D.M., Mamuris, Z., Moutou, K.A. (2011) White muscle growth in gilthead sea bream larvae (*Sparus aurata*); fibers and genes, 381-382, Mediterranean Aquaculture 2020 Proceedings, October 18-21, Rhodes, Greece

Moutou, K.A., Codina, M., **Georgiou, S.**, Gutiérrez, J., Mamuris, Z. (2009) Myosin light chain 2 in gilthead sea bream (*Sparus aurata*): a molecular marker of muscle development and growth, 289-292, Special Publication No. 38, European Aquaculture Society Proceedings, Oostende, Belgium

### *In submission:*

- Myosin light chain 2 isoforms in gilthead sea bream (*Sparus aurata*, L): a paradigm of divergent evolution

Stella Georgiou, Elena Sarropoulou, Marta Godina, Deborah M. Power, Joaquim Gutierrez, Zisis Mamuris, Katerina A. Moutou

- Expression of skeletal myosin light chain 2 (MLC2) in gilthead sea bream (*Sparus aurata*, L): developmental regulation and correlation with growth markers

Stella Georgiou, Helen Alami-Durante, Deborah M. Power, Zisis Mamuris, Katerina A. Moutou

### *In preparation:*

- Can myosin light chain 2 isoforms serve as growth markers?

Stella Georgiou, Pavlos Makridis, Dimitris Dimopoulos, Deborah M. Power, Zisis Mamuris, Katerina A. Moutou

## ***Acknowledgments***

Almost to the end of this doctoral journey, I feel deeply the need to thank all the people who have been there for me even if words are never enough to express my gratitude to them.

Above all, I owe my sincerest thanks and heartfelt gratitude to my supervisor Assoc. Prof. Dr. Katerina Moutou for her guidance, support, inspiration and excellent scientific knowledge among others. I have been under her supervision since I was an undergraduate student and during this fruitful period she always encouraged me to find my way through all the difficulties that came up. She wrote a great research proposal that allowed me to work with different techniques, to travel and meet wonderful people.

I have been also very fortunate with the other two supervisors, Prof. Dr. Zisis Mamuris and Prof. Dr. Deborah M. Power. Special thanks to Dr. Mamuris for his advice, support and his instructive comments. I have always felt very welcome in his lab in the University of Thessaly in Greece. I am grateful to Dr. Power for giving me the opportunity to work in her lab in the Center of Marine Sciences in Portugal. She has provided insightful discussions and fresh scientific ideas. I have learnt a lot of her.

I would also like to thank the committee members Prof. Kostas Mathiopoulos, Assoc. Prof. Georgios Koumoundouros and Assist. Prof. Efthimia Antonopoulou. I appreciate their constructive feedback and their suggestions. I am grateful to another examiner, Elena Sarropoulou, Research. C grade, for her help with the bioinformatic analyses and her thoughtful and detailed comments.

I am thankful to Dimitris Dimopoulos and Dias Aquaculture for providing gilthead sea bream larval samples for the examination of the early developmental stages and the juveniles for the size-grading experiment. In addition, the hatchery staff deserves my thanks.

I would like to thank Research. Pavlos Makridis, and the Hellenic Center for Marine Research, for his assistance and for providing samples for the experiment of the rearing systems.

My sincere thanks are given to members of Laboratory of Genetics, Evolutionary and Comparative Biology for their friendship and assistance, especially Dr. Constantinos Stamatis and Lectur. Dr Theologia Sarafidou. My special thanks to Dr. Ioannis Margaritopoulos for being a valuable friend and for his assistance with statistical analyses.

During these years, I was given the chance to visit other labs and meet people who will remain dear to me. I would like to express my appreciation to the members of Comparative Molecular Endocrinology Group in the Center of Marine Sciences in Portugal that made my staying there both enjoyable and productive. In particular, Isabel Morgado, Lilian Anjos, Rute Martins, Pedro Palma, Rita Costa, Patricia Pinto, most of them turned out to be more of friends than colleagues. I could not complete my work with the cell assays without the help of Joao Cardoso. I admire his positive energy and his friendship means a lot to me.

Special thanks go to Research. H  l  ne Alami-Durante for welcoming me to her lab in P  le d'Hydrobiologie in France and guided me through techniques studying muscle formation. Also, not to forget Marriane Cluzeaud and Didier Bazin for their valuable contribution.

I would like to thank the organizations that funded this PhD thesis and the relevant expenses. This research has been co-financed by the European Union (European Social Fund – ESF) and Greek national funds through the Operational Program "Education and Lifelong Learning" of the National Strategic Reference Framework (NSRF) - Research Funding Program: Heracleitus II. Investing in knowledge society through the European Social Fund. The trip to France for the muscle cellularity measurements in P  le d'Hydrobiologie was funded by a COST action short term scientific mission (European Cost for Science and Technology). My visit to Portugal for the work with the cell cultures was funded by the ERASMUS programme through the Operational Program "Education and Lifelong Learning" of European Union. Many thanks to ASSEMBLE Marine (EU FP7) for the support.

Lastly, but most importantly, I would like to thank from the bottom of my heart my parents and especially my mother for always being there for me. To my dearest friends Dimitra and Eleni that have been standing by me all along this demanding PhD journey: Thank you!



## Table of Contents

### Chapter 1 General Introduction

<b>1.1</b>	<b>Introduction .....</b>	<b>3</b>
1.1.1	The fish farming industry.....	3
1.1.2	Gilthead sea bream: biology and habitat.....	4
1.1.3	Aquaculture: past and present .....	5
1.1.4	Farming systems.....	6
1.1.5	Axial skeletal muscle: origin, development and growth .....	9
1.1.6	Growth hormone and IGFs: endocrine regulation of muscle growth.....	13
1.1.7	Contractile apparatus.....	16
1.1.8	Myosin light chain 2 in gilthead sea bream.....	19
1.1.9	The 3' UTRs in gene regulation .....	21
1.1.10	Genomic resources in gilthead sea bream.....	26
1.1.11	Whole genome duplication in teleosts .....	28
<b>1.2</b>	<b>Objectives of the study .....</b>	<b>30</b>

### Chapter 2 Myosin light chain 2 isoforms in gilthead sea bream (*Sparus aurata*, L): a paradigm of divergent evolution

<b>2.1</b>	<b>Introduction .....</b>	<b>35</b>
<b>2.2</b>	<b>Materials and Methods.....</b>	<b>39</b>
2.2.1	Bioinformatic analyses .....	39
2.2.1.1	mlc2a and mlc2b sequences.....	39
2.2.1.2	mlc2a and mlc2b genomic organization .....	39
2.2.1.3	Comparative genomics.....	40
2.2.1.4	Phylogenetic relationships.....	40
2.2.2	Gene expression .....	44
2.2.2.1	Experiment 1: mlc2 expression patterns during development .....	44

2.2.2.2	Experiment 2: <i>mlc2</i> expression during myoblast proliferation and differentiation .....	44
2.2.2.3	Experiment 3: Effect of growth hormone on <i>mlc2</i> expression .....	45
2.2.3	Determination of gene expression .....	45
2.2.4	Statistical analyses .....	48
<b>2.3</b>	<b>Results .....</b>	<b>49</b>
2.3.1	Bioinformatic analyses.....	49
2.3.1.1	Identification of homologous <i>mlc2</i> isoforms in teleosts.....	49
2.3.1.2	<i>Mlc2a</i> genomic organization and establishment of syntenic relationships .....	49
2.3.1.3	<i>Mlc2b</i> genomic organization and establishment of syntenic relationships .....	51
2.3.1.4	Phylogenetic relationships.....	53
2.3.2	Gene expression .....	54
2.3.2.1	Expression of <i>mlc2</i> transcripts during development .....	54
2.3.2.2	Expression of <i>mlc2</i> transcripts and myogenic factors during myoblast proliferation and differentiation .....	56
2.3.2.3	Effect of growth hormone on <i>mlc2</i> and myogenin expression.....	60
<b>2.4</b>	<b>Discussion.....</b>	<b>62</b>
<b>Chapter 3 The 3' untranslated regions of <i>mlc2</i> isoform A: structure and function</b>		
<b>3.1</b>	<b>Introduction .....</b>	<b>70</b>
<b>3.2</b>	<b>Materials &amp; Methods.....</b>	<b>73</b>
3.2.1	Bioinformatic analysis of <i>mlc2a</i> 3' UTRs .....	73
3.2.1.1	<i>mlc2a</i> secondary structures prediction .....	76
3.2.1.2	<i>mlc2a</i> 3' UTRs regulation of expression .....	76
3.2.2	Construction of the recombinant plasmids.....	77
3.2.2.1	Cell culture and cell transfections.....	78

3.2.2.2	Luciferase assay .....	79
<b>3.3</b>	<b>Results.....</b>	<b>80</b>
3.3.1	The 3' untranslated regions of <i>mlc2a</i> alternative transcripts.....	80
3.3.2	Bioinformatic analysis of <i>mlc2a</i> 3' UTRs.....	82
3.3.3	<i>mlc2a</i> secondary structures.....	85
3.3.4	<i>mlc2a</i> 3' UTRs modify gene expression in vitro .....	90
<b>3.4</b>	<b>Discussion .....</b>	<b>91</b>
3.4.1	3' UTRs: structures, regulation and biological significance .....	91
<b>Chapter 4 Developmental regulation of Myosin Light Chain 2 in gilthead sea bream (<i>Sparus aurata</i> L.) and correlation with muscle growth markers</b>		
<b>4.1</b>	<b>Introduction .....</b>	<b>101</b>
<b>4.2</b>	<b>Materials &amp; Methods .....</b>	<b>104</b>
4.2.1	Fish and sampling stages.....	104
4.2.2	Morphometric analysis.....	104
4.2.3	RNA extraction.....	105
4.2.4	Relative quantification of gene expression by real-time PCR analysis.....	105
4.2.5	Statistical analyses .....	108
<b>4.3</b>	<b>Results.....</b>	<b>109</b>
4.3.1	Morphometry .....	109
4.3.2	Developmental changes in the epaxial myotome of larvae .....	113
4.3.3	Gene expression patterns.....	115
4.3.4	Hierarchical gene clustering.....	120
<b>4.4</b>	<b>Discussion .....</b>	<b>122</b>
4.4.1	Muscle cellularity.....	122
4.4.2	Gene expression and muscle development.....	123
<b>4.5</b>	<b>Concluding remarks.....</b>	<b>127</b>
<b>Chapter 5 Can myosin light chain 2 isoforms serve as growth markers?</b>		

---

<b>5.1</b>	<b>Introduction .....</b>	<b>130</b>
<b>5.2</b>	<b>Materials &amp; Methods .....</b>	<b>133</b>
5.2.1	Experiment 1: Intensive vs mesocosm larvae rearing .....	133
5.2.2	Experiment 2: Size-grading .....	134
5.2.3	Gene expression analysis .....	135
5.2.4	Statistical approach .....	136
5.2.4.1	Experiment 1 .....	136
5.2.4.2	Experiment 2 .....	136
<b>5.3</b>	<b>Results .....</b>	<b>139</b>
5.3.1	Experiment 1 .....	139
5.3.2	Experiment 2 .....	142
<b>5.4</b>	<b>Discussion .....</b>	<b>148</b>
<b>Chapter 6 General Discussion</b>		
<b>6.1</b>	<b>General discussion .....</b>	<b>154</b>
<b>6.2</b>	<b>Concluding remarks .....</b>	<b>165</b>
<b>Future Directions</b>		
	<b>References .....</b>	<b>171</b>
<b>ANNEX I – Abbreviations List</b>		

## Index of Figures

### Chapter 1 General Introduction

<b>Figure 1</b>	Mediterranean aquaculture production in 2010 per country and per species	3
<b>Figure 2</b>	Schematic representation of the main stages in gilthead sea bream development	5
<b>Figure 3</b>	Main factors affecting gilthead sea bream fry production	6
<b>Figure 4</b>	Larval density defines the intensity of the larviculture system	7
<b>Figure 5</b>	Myotome development of a zebrafish somite schematically represented in dorsal view	11
<b>Figure 6</b>	Myogenetic events in fish teleost skeletal muscle	12
<b>Figure 7</b>	Schematic illustration of skeletal muscle growth under the regulation of by the GH system in teleost fish	16
<b>Figure 8</b>	Representation of the proteins of the sarcomere assembly revealed by fast skeletal muscle transcriptome	18
<b>Figure 9</b>	The myosin II molecule consists of two heavy chains and two pairs of light chains	19
<b>Figure 10</b>	Alignment of the deduced amino acid sequences of both MLC2 isoforms in gilthead sea bream	20
<b>Figure 11</b>	Gene expression of an mRNA molecule is a multi-step process	22

### Chapter 2 Myosin light chain 2 isoforms in gilthead sea bream (*Sparus aurata*, L): a paradigm of divergent evolution

<b>Figure 1</b>	Schematic representation of primer binding that were designed to determine gene expression of <i>mlc2a</i> alternative transcripts	45
<b>Figure 2</b>	Comparative drawing illustrating the predicted exon-intron organization of <i>mlc2a</i> gene across the species under investigation using the Spidey program	47
<b>Figure 3</b>	Comparative drawing illustrating the predicted exon-intron organization of <i>mlc2b</i> gene across the species under investigation using the Spidey program	49
<b>Figure 4</b>	Phylogenetic relationships among ten fish species coding for <i>mlc2a</i> and <i>mlc2b</i> genes	51
<b>Figure 5</b>	Expression patterns of (A) <i>mlc2</i> isoforms, myogenin and <i>myoD2</i> and (B) <i>mlc2a</i> transcripts, during embryogenesis and in developing larvae of gilthead sea bream	53

<b>Figure 6</b>	Expression patterns of (A) <i>mlc2</i> isoforms, (B) myogenin and <i>myoD2</i> , and (C) <i>mlc2a</i> alternative transcripts in primary muscle cell cultures of gilthead sea bream	58
<b>Figure 7</b>	Expression patterns of <i>mlc2a</i> (A), <i>mlc2b</i> (B) and myogenin (C) in the white muscle of juvenile gilthead sea bream	60
<b>Chapter 3 The 3' untranslated regions of <i>mlc2</i> isoform A: structure and function</b>		
<b>Figure 1</b>	Schematic representation of the pGL3-Promoter vector with the 3' UTR constructs	79
<b>Figure 2</b>	Gilthead sea bream <i>mlc2a</i> gene	82
<b>Figure 3</b>	Predicted secondary structure for <i>mlc2a</i> short transcript	86
<b>Figure 4</b>	Predicted secondary structure for <i>mlc2a</i> medium transcript	87
<b>Figure 5</b>	Predicted secondary structure for <i>mlc2a</i> long transcript	88
<b>Figure 6</b>	Transient expression of firefly luciferase gene in CHO cell cultures. Assays were performed 72 h after transfection	89
<b>Chapter 4 Developmental regulation of Myosin Light Chain 2 in gilthead sea bream (<i>Sparus aurata</i> L.) and correlation with muscle growth markers</b>		
<b>Figure 1</b>	White muscle morphometry	108
<b>Figure 2</b>	Frequency of fibers with diameter <5 $\mu\text{m}$ , mean diameter, mean perimeter and mean area of white muscle fibers in gilthead sea bream larvae on 25, 35, 45 and 60 dph, respectively	110
<b>Figure 3</b>	Expression patterns of structural and regulatory genes in developing gilthead sea bream larvae	114
<b>Figure 4</b>	Expression patterns of the three alternative transcripts of <i>mlc2a</i> in developing gilthead sea bream larvae	117
<b>Figure 5</b>	Hierarchical clustering of the eight target genes during gilthead sea bream larval development	119
<b>Chapter 5 Can myosin light chain 2 isoforms serve as growth markers?</b>		
<b>Figure 1</b>	Graphical scheme of the three-stage size-grading procedure	134
<b>Figure 2</b>	Evolution of total length in gilthead sea bream larvae reared in intensive and mesocosm systems up to 55 days post hatch	137
<b>Figure 3</b>	<i>mlc2a</i> (A), <i>mlc2b</i> (B) and <i>mlc2a/mlc2b</i> (C) expression levels in gilthead bream individuals reared in intensive or mesocosm system during hatchery stages	139
<b>Figure 4</b>	<i>mlc2a</i> expression levels in the groups of gilthead sea bream generated in three successive size-sortings	141
<b>Figure 5</b>	<i>mlc2b</i> expression levels in the groups of gilthead sea bream generated in three successive size-sortings	142

---

<b>Figure 6</b>	<i>mlc2a/mlc2b</i> expression levels in the groups of gilthead sea bream generated in three successive size-sortings	143
<b>Figure 7</b>	Correlation between (A) <i>mlc2a</i> , (B) <i>mlc2b</i> , (C) <i>mlc2a/mlc2b</i> expression levels and total length in gilthead sea bream after three size-sortings	144

## Index of Tables

### Chapter 1 General Introduction

<b>Table 1</b>	Rearing techniques differences	7
----------------	--------------------------------	---

### Chapter 2 Myosin light chain 2 isoforms in gilthead sea bream (*Sparus aurata*, L): a paradigm of divergent evolution

<b>Table 1</b>	List of the potential homologues of <i>mlc2</i> isoforms found in teleost species in the NCBI databases	40
----------------	---	----

<b>Table 2</b>	Primers used for real-time PCR gene expression (Q-PCR) analysis	44
----------------	---	----

<b>Table 3</b>	<i>In silico</i> identification of potential homologues of both <i>mlc2</i> isoforms in teleost species under study	48
----------------	---	----

### Chapter 3 The 3' untranslated regions of *mlc2* isoform A: structure and function

<b>Table 1</b>	Sequences and origin of the <i>cis</i> -acting elements located in the 3' UTRs that modify gene expression in various species	74
----------------	---	----

<b>Table 2</b>	Sequences and origin of the <i>cis</i> -acting elements identified in the 3' UTRs of <i>mlc2a</i> -short, -medium and -long transcripts	84
----------------	---	----

### Chapter 4 Developmental regulation of Myosin Light Chain 2 in gilthead sea bream (*Sparus aurata* L.) and correlation with muscle growth markers

<b>Table 1</b>	Gene identity, accession number and the forward and reverse primers used for real-time PCR (Q-PCR) gene expression analysis	105
----------------	---	-----

<b>Table 2</b>	Number of epaxial and hypaxial myomeres in gilthead sea bream larvae	112
----------------	--	-----

<b>Table 3</b>	Spearman rank correlation coefficients between structural genes, myogenic and regulatory factors in developing gilthead sea bream larvae	116
----------------	--	-----

### Chapter 5 Can myosin light chain 2 isoforms serve as growth markers?

<b>Table 1</b>	Genes, accession numbers, and primers used for real-time PCR gene expression analysis	136
----------------	---	-----

<b>Table 2</b>	Mean weight, mean total length and range of length in gilthead sea bream size-graded per growth period	140
----------------	--	-----



## Summary

In gilthead sea bream skeletal muscle two isoforms of myosin light chain 2 (MLC2) are expressed, A and B. MLC2A is encoded by three transcripts produced through alternative polyadenylation signal selection differing in the 3' untranslated region. *cis*-acting regulatory elements residing in 3' UTRs were identified using bioinformatic analysis. Functionality of 3' UTRs in interaction with the cell protein machinery was investigated *in vitro* using luciferase reporter constructs. Data indicated that the three transcripts are subject to differential regulation according to 3' UTR length and regulatory interactions between transcripts were detected.

Gene organization of the two isoforms and the syntenic relationships between gilthead sea bream, European sea bass, zebrafish, Atlantic cod, three-spined stickleback, medaka and tetraodon were studied. *mlc2a* and *mlc2b* genes contain 5 and 6 exons respectively in all organisms examined. Exon-intron organization is more similar among evolutionary closer species which is further confirmed by the phylogenetic tree probably indicating different evolutionary trajectories for the two *mlc2* isoforms. Divergent expression patterns during myogenesis in primary muscle cell cultures and in developing larvae, and after administration of growth hormone to juveniles, indicated that the two isoforms of *mlc2* identified in the gilthead sea bream are duplicated genes (paralogues) which have probably undergone subfunctionalization.

White muscle development and growth processes occur through hyperplastic and hypertrophic events driven by several regulatory and hormonal factors. The development of white musculature in gilthead sea bream larvae demonstrated distinct hyperplastic and hypertrophic phases as evident by changes in muscle cellularity. The expression patterns of MLC2 marked the two phases in an isoform-specific manner; MLC2A marked new fiber formation in the germinal zones, appeared early in development and was correlated to myogenic factors; MLC2B was up-regulated only at hypertrophy in a later developmental stage and was correlated to muscle structural genes.

The effect of rearing conditions to *mlc2* isoform plasticity was determined in larvae and juvenile sea bream outcoming from the same egg-batch and raised under intensive versus mesocosm conditions as well as in juvenile gilthead sea bream reared under commercial aquaculture practices subjected to size-grading with sorters of increasing

diameter. In the rearing systems experiment, larvae raised in mesocosm outperformed in growth and *mlc2* isoform expression those raised under intensive. Results from the size-grading experiment suggested that somatic growth of juvenile gilthead sea bream was modestly improved. The ratio of *mlc2a/mlc2b* expression was significantly correlated to axial growth during the larval and early juvenile stages.

Given the plastic versatility prevailing early development, the present results provide strong evidence of the robustness of *mlc2* isoforms as markers of early growth.

*Chapter Σφάλμα! Χρησιμοποιήστε την καρτέλα "Κεντρική σελίδα", για να εφαρμόσετε το Heading 1 στο κείμενο που θέλετε να εμφανίζεται εδώ.*

---

# ***Chapter 1***

*Chapter Σφάλμα! Χρησιμοποιήστε την καρτέλα "Κεντρική σελίδα", για να εφαρμόσετε το Heading 1 στο κείμενο που θέλετε να εμφανίζεται εδώ.*

---

## Chapter 1

### General Introduction

#### 1.1 Introduction

##### 1.1.1 The fish farming industry

Fish farming has been the most rapidly expanding activity of the primary sector in Greece for more than twenty years. From local fish farms to technologically advanced hatcheries aquaculture has to meet the ever-increasing consumer demands for better quality fish in a profitable manner. Greece is the leader country in aquaculture in the Mediterranean and the top European producer of gilthead sea bream and European sea bass (FEAP 2011, Figure 1). More than 76 % of production volume of gilthead sea bream is exported making this species the pioneer exportable product of the primary sector with an export value of 415 million euros in 2007 (Federation of Greek Mariculture 2008).

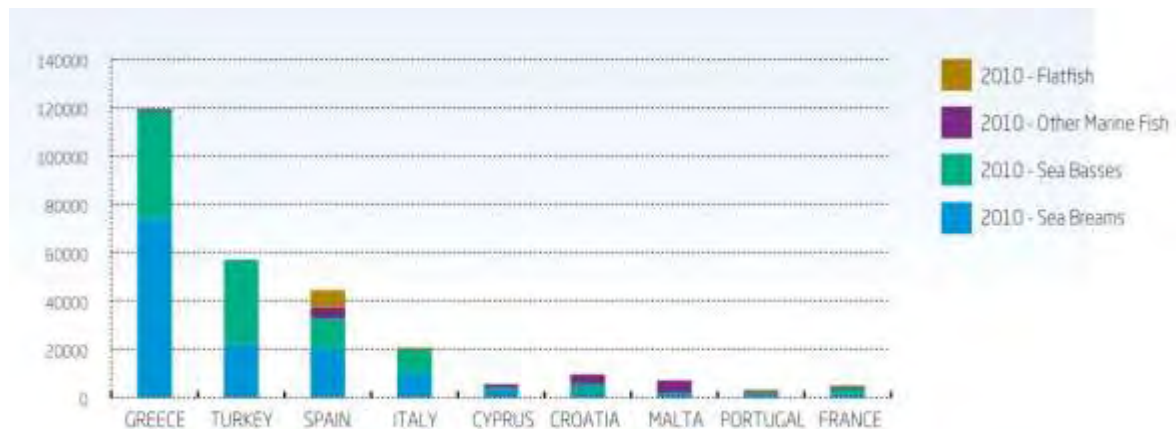

**Figure 1:** Mediterranean aquaculture production in 2010 per country and per species. Greece is the leading producer of gilthead sea bream and European sea bass (Adapted from FEAP Annual Report 2011).

### 1.1.2 Gilthead sea bream: biology and habitat









The gilthead sea bream (*Sparus aurata*, L) is a marine teleost that belongs to the family Sparidae. It is commonly distributed in the Mediterranean Sea, present in the Eastern Atlantic and rarely encountered in the Black Sea. As an euryhaline species, gilthead sea bream inhabits marine or brackish water environments of seagrass beds, sandy or rocky bottoms, and can reach from 30 m to 150 m depth as an adult. It is mainly carnivorous, preying on shellfish, crustaceans and fish, and accessorially herbivorous. It is a protandrous hermaphrodite with a breeding period ranging from October to December depending on social, environmental (photoperiod, water temperature) and genetic factors (Zohar et al. 1978, 1984).

<i>Sparus aurata</i>	
Kingdom	Animalia
Phylum	Vertebrata
Class	Actinopterygii
Order	Perciformes
Family	Sparidae
Genus	Sparus
Species	aurata



For the first two years gilthead sea bream is a functional male and at sizes over 30 cm it turns to female (Sola et al. 2007; FEAP 2011; FAO). Due to the great importance of gilthead sea bream for the marine aquaculture an increasing number of scientific papers exploring its physiology, nutrition, immune response, growth performance, reproduction and genetics have been produced (for review, see Pavlidis & Mylonas 2011).

Dramatic ontogenic changes occur during gilthead sea bream larva to adult developmental transition. Larvae go through biological, physiological, morphological, anatomical and behavioral changes accompanied by a tremendous increase in biomass gain. Key developmental time points are yolk sac resorption, swimbladder formation, notochord flexion, fin ray formation, pigmentation and squamation, and sexual maturation (Patrino et al. 1998; Russo et al. 2007; Koumoundouros et al. 2009). At the end of metamorphosis (metamorphosis occurs around 45 dph) larvae have already attained adult features, such as a functional digestive tract, innate immunity response, improved visual performance and exhibit enhanced locomotor and foraging activity due to the progressively advanced musculature mechanically supported by the skeleton (Fernald 1990; Koumoundouros et al. 1997; Patrino et al. 1998; koumoundouros et al. 2009; Uribe et al. 2011). The major milestones of gilthead sea bream development are illustrated in Figure 2.

days and stages	mm length	n° somites	yolk sac	gut	alimention	swimming	caudal fin	
HATCHING 0 	2.5	21	present	not open mouth	/	first attempts of darting movements		
PRE-LARVA 1	2.6	22						
LARVA 6 	3.5	23	partially resorbed	open mouth	first attempts of feeding	active darting movements		
9	3.7	24						
15 	3.9	24		development of gut and glands in progress	active feeding	continuous eel-like swimming plus darting movements		
18	4.3	24						
30 	5.5	25	not present			continuous effective swimming improved by swim bladder		
45 <b>METAMORPHOSIS</b>	8.1							
FRY 60 	14			functional gut	very active feeding			
90 	20					combined eel-like and hydrofoil swimming		
150 	28							

**Figure 2:** Schematic representation of the main stages in gilthead sea bream development (Patrino et al. 1998).

### 1.1.3 Aquaculture: past and present

At its infancy fish rearing relied upon the exploitation of wild stocks and took advantage of species that were easy to adapt. Upon industrialization, marine aquaculture had to deal with many issues regarding availability and quality of fry, artificial reproduction and infrastructure of culture systems (Figure 3). These issues were gradually addressed with the sophistication of culture systems that are designed in order to meet species-specific biological needs and imitate habitats. Great attention was given in replicating

environmental conditions, such as light intensity, temperature, salinity, water quality as well as avoiding disease outbreaks and optimizing feeds.

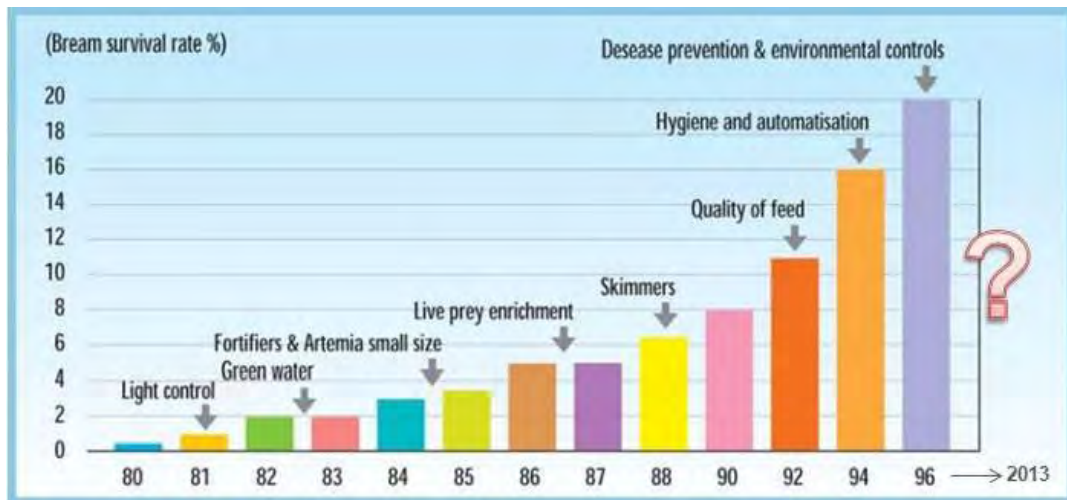

**Figure 3:** Main factors affecting gilthead sea bream fry production (Adapted from Moretti et al. 1999).

In the last decade the main concerns of the aquaculture business have been focusing on enhancing the biological performance, i.e. survival and growth, increasing biomass gain and eliminating deformities while lowering the costs. Selection and breeding programs are undertaken to enhance the genetic predisposition of progenies to faster growth, survival and disease tolerance towards high productivity. Nowadays larviculture conditions diverse according to species demands in contrast to broad production schemes used extensively for the aquaculture of many species simultaneously. The central goal is to produce fry of predictable growth performance resulting in high-quality juveniles that satisfy both the market demands and an economically thriving fish farming industry.

#### 1.1.4 Farming systems

Aquafarming has to take into account the individual requirements for food and the attained sizes during the developmental stages in order to accommodate each species successfully. For example, gilthead sea bream can be produced in coastal ponds and lagoons, under extensive and semi-intensive systems or in land-based facilities and in sea cages, using the intensive technology. Selection of each method is based on fish farming density and food supply. Furthermore, European hatchery techniques can be classified according to



different rearing parameters, mainly larval stocking density, prey source and availability, quality and renewal of water, hydroid circuit, supplemental enrichment of food and infrastructures (Table 1, Divanach & Kentouri 2000; Shields 2001). Larval density defines the intensity of the culture system, which spans from 0.1-1 larvae L<sup>-1</sup> in the extensive technology to 150-200 larvae L<sup>-1</sup> in the hyperintensive technology, and forms the basis of the technical classification of the intensive, mesocosm and extensive techniques (Figure 4).

**Table 1:** Rearing techniques differences (Divanach & Kentouri 2000).

Parameters	Techniques		
	Extensive	Mesocosm	Intensive <sup>†</sup>
Rearing enclosures	Ponds or bags	Tanks or bags	Tanks
Localisation	Outdoor	In door <sup>††</sup>	Indoor
Rearing volume (m <sup>3</sup> )	>100	30-100	<20
Rearing density (ind/l)	0.1-1	2-8	30-200
Food chain	Endogenous	Mixed	Exogenous
Infrastructures	Light	Medium	Sophisticated
Environment	Natural	Mixed	Controlled
Autonomy and autarky	High	Medium	Low to nil
Dependence on man and technique	Light	Medium	High to very high
Need for specific biological knowledge	Light	Medium	High to very high
Validity for new species	Very high	High	Medium to low

<sup>†</sup>Integrate semi-intensive, intensive and hyper-intensive techniques.

<sup>††</sup>Sometimes outdoor (with bags) or semi-outdoor.

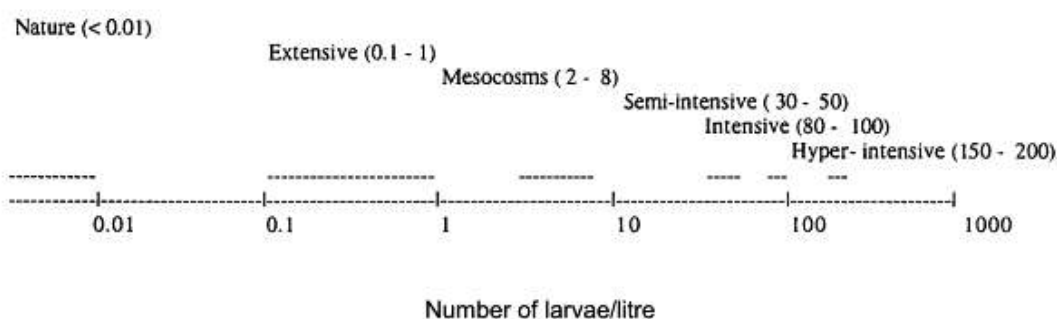

**Figure 4:** Larval density defines the intensity of the larviculture system (Divanach & Kentouri 2000).

In intensive culture systems larval stocking density is very high (30-200 larvae L<sup>-1</sup>), depending on fish species, their ability to grow in high stocking densities and their tolerance

towards environmental parameters. The biological demands of each fish species has to be taken into consideration in order to replicate the most suitable environment. To that direction oxygen concentration, temperature, salinity, food supply, light intensity, water quality and renewal are monitored and closely controlled (Divanach & Kentouri 2000; Shields 2001). Disease outbreaks, low survival rates, eye cataracts, fin erosion, skeletal deformities, soft tissue anomalies are among the issues with severe ramifications in intensive fish culture. These issues are significantly down-scaled in the mesocosm system, a more natural open-sea-like habitat of very low density (2-10 larvae L<sup>-1</sup>), where fish are fed on endogenously produced physical blooms of phytoplankton and zooplankton in the early developmental stages (Divanach & Kentouri 2000). Later on at development, exogenous prey is supplemented to meet the augmented nutritional requirements. Mesocosm technique appears to be more advantageous for larval rearing as higher survival rates (Divanach & Kentouri 2000; Papandroulakis et al. 2004), higher development and growth rates (Benetti 2001; Andrade et al. 2012), better nutritional status (Zouiten et al. 2011), more wild-like external appearance (Valente et al. 2011) are observed and skeletal development is more advanced (Zouiten et al. 2011). Mesocosm system has proven to be industrially successful since more than twenty fish species have been cultured and it can be the system of choice when knowledge of biological performance is limited (Divanach & Kentouri 2000; Papandroulakis et al. 2004).

A major shortcoming in the commercial finfish production is the size heterogeneity in the same cohorts of juvenile fish. This phenomenon is called growth depensation and results in asynchronous growth rates and size disparity in the final merchantable product (Smith & Fuiman 2003; Benhaïm et al. 2011). According to Kestemont et al. (2003) size variation has a genetic basis [fast-growers vs slow-growers (Valente et al. 1999; Borrell et al. 2011) and is influenced by genotype-environment interactions (Johnston 1999, 2008). Furthermore, social behavior and the established dominant-subordinate relationships may lead to disproportional access to food, stress and ultimately in variable growth rates (Sunde et al. 1998). In the effort to eliminate those discrepancies fish farmers have introduced frequent size gradings of individuals from the same batch. The aim of this stressful procedure is the creation of cohorts of the same size-at-age specimens and the presumable avoidance of the social interactions. However, not all fish species respond in the same way to size grading; survival, growth rates and biomass gain are highly dependent on species or strain (Zakęś et al. 2004; Benhaïm et al. 2011).

### *1.1.5 Axial skeletal muscle: origin, development and growth*

From a production point of view, skeletal muscle is the target tissue for fish farming as it is the edible part of the fish, i.e. the fillet. In contrast to mammals, in which new muscle fiber formation ceases at the postnatal period, recruitment of muscle fibers in fish continues throughout lifetime (Goldspring 1972; Johnston 1998). Unraveling the mechanisms that regulate muscle development and growth is of paramount importance for the aquaculture industry in order to manipulate the inherent growth potential of cultivated fish and accelerate fish body growth.

Somatic growth is the progressive increase in body size or weight gain controlled by both endogenous (hormonal-induced) or extrinsic (nutritional or environmental) signals (Company et al. 2001; Pèrez-Sánchez et al. 2002; Gahr et al. 2008). Given that teleost axial skeletal muscle mass can account for up to 70 % of body mass (Alami-Durante et al. 2010a), somatic growth depends on new muscle fiber formation and enlargement of the existed ones. Muscle, a tissue of mesodermal origin, develops in three phases, starting in the embryonic life and advancing far into adulthood. The adult teleost myotome architecture is defined by white, red and pink muscle fibers. White muscle fibers are fast-twitch, recruited at high speed swimming and their metabolism is based on anaerobic glycolysis and phosphocreatine hydrolysis. On the contrary, red muscle fibers are slow-twitch and are based on aerobic metabolism. Intermediate pink fibers possess physicochemical properties resembling both muscle fiber types and function accordingly (Rowlerson & Veggetti 2001).

In teleost fish, the embryonic primary myotome is composed of two cell types, the slow red fibers and the fast white ones. During the first myogenetic phase occurring in the embryo (embryonic myogenesis), mononucleated myogenic precursors adjacent to the notochord (adaxial cells) undergo a mediolateral migration (Figure 5B-C) giving rise to the superficial slow fiber monolayer just underneath the dermomyotome (Figure 5D). Adaxial cells start differentiating while they are in the segmental plate and begin the expression of slow and fast muscle fiber contractile proteins (Rescan et al. 2008). As soon as they are incorporated into the somite, they elongate and start differentiating. Commitment of the adaxial cells to the slow fiber type is under the influence of sonic hedgehog (Shh) signaling by the notochord. Myogenetic differentiation depends on the coordinated action of the myogenic regulatory factors (MRFs) MyoD, Myf5, Myogenin and Mrf4 combined with the

action of the myocyte enhancer factor 2 (MEF2) family of MADS box factors (Ferri et al. 2009).

The anterior and the posterior domain of the somite encompass two cell populations that form separate myogenic zones in the myotome. Anterior somitic cells under the influence of the Dsf family of cytokines (Hollway et al. 2007) migrate to the outermost surface, external to the slow layer, establishing the external cell layer. The deep fast fibers originate from lateral paraxial cells of the posterior somite after they have been passed by the migrating slow fibers precursors during somite rotation (Figure 5D, Hollway et al. 2007; Rescan et al. 2008). Fibroblast growth factor 8 (Fgf8) triggers *myoD* expression and guides fast muscle precursors to terminal differentiation (Groves et al. 2005). Dermomyotome Pax3/Pax7 positive cells are the source of myogenic precursor cells (MPCs) (Hollway et al. 2007).

Succeeding embryonic hyperplasia, the second phase of muscle formation initiates in the late embryo and continues in newly hatched larvae. The formation of muscle growth zones starts at the myotome scaffold, generating muscle fibers in discrete layers (stratified hyperplasia) and is particularly intense in areas of very small diameter fibers at the dorsal and ventral apices as well as lateral to the embryonic slow fiber layer next to the horizontal septum. A hyperplastic process (the third and most important myogenetic phase) appears throughout the myotome surface with the appearance of newly formed muscle fibers, scattered between the existed ones. The existence of fibers of different ages and diameters gives a mosaic-like appearance to a muscle cross section (mosaic hyperplasia, Rowlerson & Veggetti 2001; Chauvigné et al. 2006; Steinbacher et al. 2006, 2007). Mosaic hyperplastic growth occurs mainly in the juvenile period and is absent in fish species that the ultimate size they obtain is small, such as the guppy (Weatherley et al. 1988; Veggetti et al. 1993).

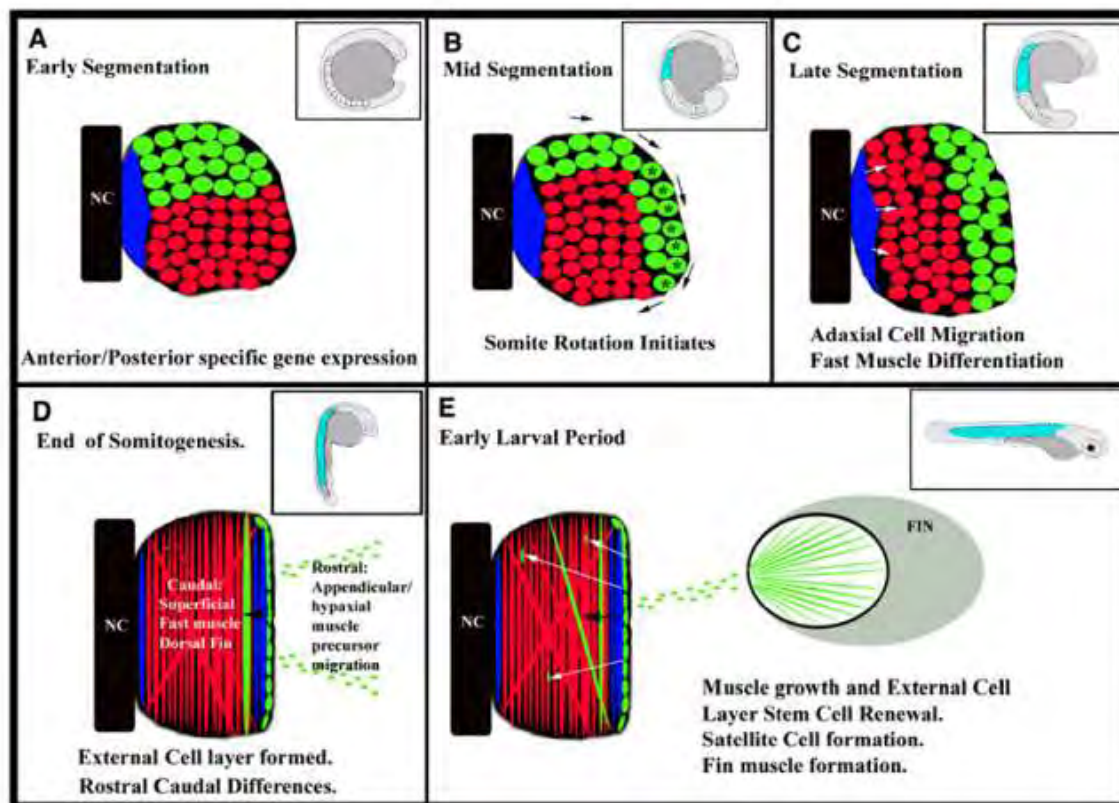
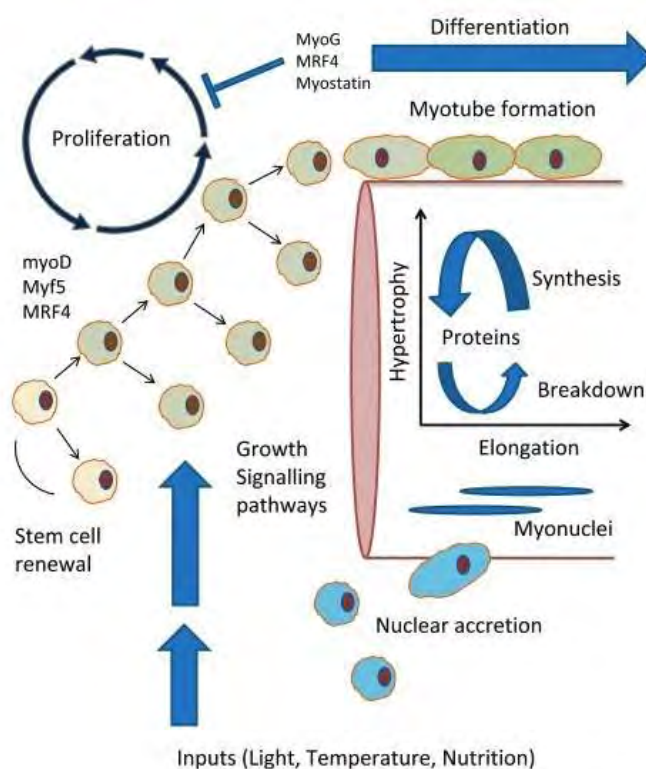

**Figure 5:** Myotome development of a zebrafish somite schematically represented in dorsal view. In the top right-hand corner of each panel the precise stage of each schematic is depicted; the somites that have completed rotation are indicated in light blue. (A) In newly formed somites of the early segmentation-stage embryo anterior/posterior gene expression is established. Adaxial cells are illustrated in blue; anterior somitic compartment cells, which express *sdf1a*, *cxcr4* receptors and *pax7*, are shown in green; posterior myogenic cells are colored in red. NC, notochord. (B) Over the next 4–5 hr, *sdf1a* expression is progressively limited to the lateral edge of the somite (depicted with an asterisk). The anterior somatic cells, that express *cxcr-4*, are stimulated by *sdf1a* expression to migrate toward the lateral aspect of the somite. At the same time, the posterior myogenic cells start to migrate anteriorly. (C) Following the 90° rotation of the somite the external cell layer is generated consisting of cells expressing *Pax7*. When rotation is completed, adaxial cells start migrating from the midline (arrows). (D) Concomitantly with slow muscle migration, differentiation is initiated in the rest of the myotome. In the rostral domain, hypaxial and appendicular muscle precursors that originated from the anterior somitic compartment begin to migrate. More caudally, cells of the anterior compartment contribute directly to fast white muscle formation (arrow) as well as to the dorsal fin. (E) The external cell layer which is present throughout development, supplies with muscle fibers (black arrow) the ongoing fish hyperplastic growth. *Pax7*-positive satellite cells deep in the myotome (white arrows) are also originated from the external cell layer. Pectoral fin derives from the anterior somitic compartment (Hollway et al. 2007).

The onset, extent and intensity of the hyperplastic mode of growth are species-specific and the waves of hyperplasia rely heavily on the evolutionary background, the final size attained by the fish (Steinbacher et al. 2006; Valente et al. 2013) and are responsive to

environmental or nutritional manipulations (Alami-Durante et al. 2000; 2006, 2007; Johnston 2006). Faster growth is observed in pike perch, carp, Atlantic cod and rainbow trout exhibiting higher rates of hyperplasia (Alami-Durante et al. 1997; Galloway et al. 1999; Valente et al. 1999; Ostaszewska et al. 2008). Higher growth rates and larger body size have been correlated to a prolonged mosaic hyperplastic phase (Weatherley et al. 1988). Finally, in teleost fish the body length in which muscle fiber synthesis comes to an end defines their capability of growth and their final size (Weatherley et al. 1998; Pitkänen et al. 2001; Johnston et al. 2004).

Fundamental myogenetic events are shared among all vertebrates and involve a series of steps in which multipotent stem cells become myoblasts. According to the current model (reviewed by Valente et al. 2013) stem cells divide asymmetrically to produce a daughter cell that becomes committed to a myogenic cell fate guided by the MRFs (MyoD, Myf5, MRF4). Upon proliferation, the daughter cell generates the myogenic progenitor cells (MPCs) population, which exits the cell cycle to initiate the terminal differentiation program. Differentiating myocytes fuse to form myotubes and subsequently mature muscle fibers under the action of myogenin (myoG), MRF4 and myostatin. Additional nuclei are also absorbed by the mature fibers as they expand in diameter in order to maintain the nuclear to cytoplasmic ratio within physiological levels (Figure 6).



**Figure 6:** Myogenetic events in fish teleost skeletal muscle (Valente et al. 2013).

#### 1.1.6 Growth hormone and IGFs: endocrine regulation of muscle growth

Muscle growth is under hormonal regulation and controlled by growth-related signaling pathways. Growth hormone (GH) is the key endocrine regulator of development, growth and reproduction pathways among other physiological processes in fish, like osmoregulation, energy allocation, immune responses (Yada et al. 1999; Björnsson et al. 2002; Sangiao-Alvarellos et al. 2006). Besides the genetic component, growth hormone stimulation and release is influenced by external stimuli, such as photoperiod, temperature and food availability that are integrated and processed by the hypothalamus, pituitary gland and the peripheral target organs and/or tissues (Moriyama et al. 2000). Enhanced growth rates and supraphysiological somatic growth have been acquired in homologous or heterologous growth hormone expression systems or growth hormone transgenic fish (Zhu et al. 1992; Chen et al. 1993; Devlin et al. 1995, 1997, 2006).

In fish, growth hormone is produced by the adenohypophysis and its secretion is controlled by other endocrine regulators including somatostatin, gonadotropin, growth hormone releasing hormone and ghrelin (Björnsson et al. 2002). Growth hormone exerts its biological functions in a dual mode of action; directly via binding to full-length growth hormone receptors (fGHRs) and indirectly via the insulin-like growth factor system (IGF). In both ways a signaling cascade is triggered and various signaling effectors mediate downstream expression of growth-related genes. In vertebrates components of the GH-IGF system have been identified and have turned out to regulate muscle growth positively (Glass et al. 2003, 2005; Wood et al. 2005; Velloso et al. 2008). In teleost fish species less is known about the involved molecules and many questions regarding the mechanisms governing the myogenetic process remained pending. Evidence coming from fish cell cultures proposes a role of the IGF system on coordination of postnatal skeletal muscle formation (Reinecke et al. 2005) by inducing proliferation and differentiation of myogenic progenitor cells (Castillo et al. 2004; Codina et al. 2008).

In vertebrates growth hormone actions initiate by binding with high affinity to the GHRs in the target tissues. The major site of growth hormone binding is the liver (Benedito-Palos et al. 2007) but other peripheral organs also express GHRs on cell surface, such as liver, muscle, fat and brain (Pérez-Sánchez et al. 1994). In mammals, upon growth hormone binding, GHR is homodimerized, the JAK/STAT signaling pathway is activated and expression of several genes is induced, including *igf1* (Moutoussamy et al. 1998).

Growth hormone encoding gene and promoter region were isolated and characterized in gilthead sea bream (Almuly et al. 2000, 2005). Growth hormone gene consists of six exons and five introns similar to other fish species except for salmonids and catfish (Almuly et al. 2000). Polymorphic sites identified in intron sequences and in promoter region were associated with growth traits. Variable length of intron I due to differences in the number of repeat 15-mer or 17-mer and of intron III has been correlated to differential growth rates (saGHFIM, Almuly et al. 2000). A higher proportion of shorter intron I occurred in hatchery reared gilthead sea breams under higher selection pressure for growth (Almuly et al. 2008). Body weight, length and size were significantly correlated to a SNP in intron I (Almuly et al. 2000; Sánchez-Ramos et al. 2005). 5' flanking region contains many sequence repeats and in particular the dinucleotide microsatellite saGHCA has been significantly linked to enhanced growth performance (Almuly et al. 2005).

During ontogeny, gilthead sea bream growth hormone has an early appearance in pituitary, from 2 days post hatch (dph) onwards (Funkenstein et al. 1992; Herrero-Turrión et al. 2003). In adult specimens growth hormone gene expression decreased progressively from 1 to 3 years old fish, indicating that growth hormone expression follows an age-dependent pattern (Martí-Palanca et al. 1996). Seasonal variation in mRNA and protein levels of growth hormone has been also reported, with the highest levels in spring and early summer pointing to regulation by photoperiod and/or ambient temperature (Pèrez-Sánchez et al. 1994; Mingarro et al. 2002; Vargas-Chacoff et al. 2009). Malnutrition, achieved by food restriction or suboptimal diets, and stress induced by handling or overcrowding were shown to alter growth hormone circulating levels (Pèrez-Sánchez et al. 1995; Company et al. 1999; Rotllant et al. 2001; Gómez-Requeni et al. 2004; Benedito-Palos et al. 2007; Bermejo-Nogales et al. 2007), while heterologous growth hormone administration to juvenile gilthead sea bream strengthened immunity (Calduch-Giner et al. 1997) as well as induced a hypoosmolegatory response (Sangiao-Alvarellos et al. 2006) and high vitellogenin expression (Mosconi et al. 2002).

The anabolic actions of growth hormone are mediated by binding to GHR1 and GHR2 in gilthead sea bream tissues (Saera-Villa et al. 2005). GHR1 and GHR2 are encoded by two different genes (Saera-Villa et al. 2007) that share a common 5' untranslated region and are under physiological, developmental and tissue-specific control (Saera-Villa et al. 2005). Tissue distribution of both GHRs differentiates with respect to liver, which is the primary target tissue presenting at least 10-fold more binding sites than skeletal muscle, brain and adipose tissue (Pèrez-Sánchez et al. 1994; Calduch-Giner et al. 2003; Saera-Villa et al. 2007).



Other growth hormone binding sites have been localized in kidney, spleen and blood cells for the same species, highlighting the pleiotropic mode of action of this hormone (Muñoz-Cueto et al. 1996). Both receptors exhibited similar expression levels in skeletal muscle but GHR1 expression was more pronounced than GHR2 in liver and adipose tissue (Saera-Villa et al. 2005). GHR1 displayed age-dependent expression in liver and skeletal muscle (Saera-Villa et al. 2005) while GHR2 expression was altered in food deprivation, with fasted juveniles exhibiting elevated GHR2 expression in skeletal muscle (Saera-Villa et al. 2007). Seasonal changes in GHRs expression levels were also detected, with both receptors being highly expressed in liver and in skeletal muscle in mid-summer and in January, respectively (Saera-Villa et al. 2007).

As mentioned beforehand, biological functions of growth hormone are exerted through the IGF system. IGF-I and IGF-II are growth-promoting polypeptides produced primarily in liver upon growth hormone stimulation. Components of this system are implicated in development, growth, differentiation and reproduction (Reinecke 2010; reviewed by Beckman 2011). In gilthead sea bream IGF system encompasses the two ligands (IGF-I and IGF-II) whose actions are mediated by IGF-I receptor (IGFIR) (Perrot et al. 1999). MAPK and PI3K/Akt cascades are triggered that are involved in muscle cell proliferation, differentiation and protein synthesis eliciting a hypertrophic response (Coolican et al. 1997; Li & Johnson 2006; Clemmons et al. 2009). During gilthead sea bream ontogeny IGF-I and IGF-II transcripts are detected in embryos, eggs and newly hatched larvae (Duguay et al. 1996; Funkenstein et al. 1996; Perrot et al. 1999) emphasizing the pivotal role of this molecule in early developmental stages. IGF-I and IGF-IR mRNAs are localized in skeletal muscle and pancreas among other tissues from 16 dph larvae (Funkenstein et al. 1997). Immunoreactivity towards IGF-II was found to follow the myofibrillogenesis process in larvae marking the new muscle fibers (Radaelli et al. 2003).

The most pronounced effect of the growth hormone-IGF pathway signaling is on inducing skeletal muscle growth (Figure 7). Although it is hard to discriminate if growth hormone acts alone or its actions are coupled with its downstream effector IGF-I *in vivo*, their combined action has induced myoblast proliferation *in vivo* for gilthead sea bream (Rius-Francino et al. 2011). In addition, in gilthead sea bream primary cell culture muscle cell proliferation and differentiation procedures were stimulated as indicated by the elevated gene expression levels of *myoD2* and *myf5* as well as myogenin and *mrf4* following administration of IGF-II and IGF-I respectively (Jiménez-Amilburu et al. 2013). The complex

interactions of GH-IGFs axis and the MRFs in myoblasts proliferation and differentiation stages must be better addressed.

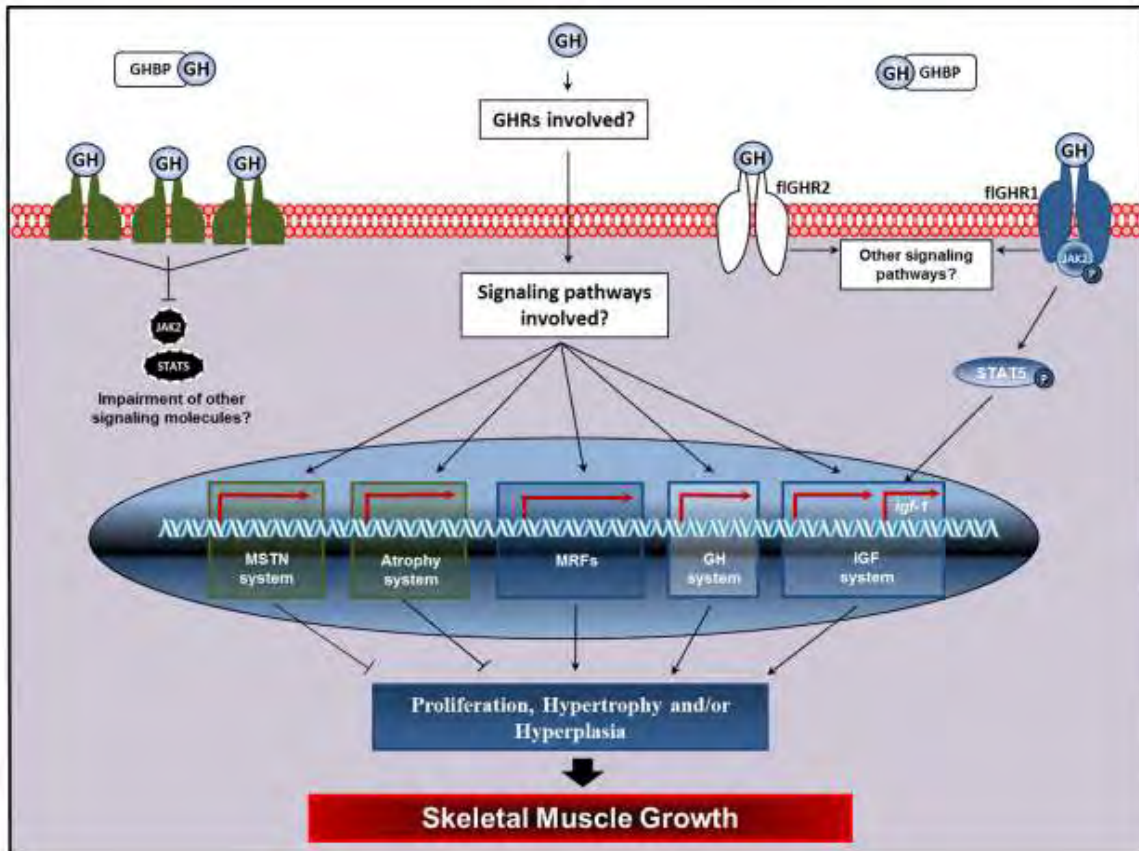

**Figure 7:** Schematic illustration of skeletal muscle growth under the regulation of by the GH system in teleost fish. Muscle growth is stimulated by growth hormone action in fish resulting in proliferation of myogenic cells and muscle hyperplasia and/or hypertrophy. The molecular pathways triggered in these processes involve the transcriptional regulation of several genes encoding MSTN, atrophy, MRFs, growth hormone, and IGF system. Transcription and biological action of other molecules are also regulated by growth hormone. The type of flGHRs (i.e. flGHR1 and/or flGHR2), involvement of GHBP and flGHR2 and specific signaling cascades that trigger the expression of these molecules still remain unknown. Also, if growth hormone has a direct or indirect effect mediated by muscle-derived IGF1 on muscle growth remains to be answered. White-symbols (i.e. molecules and boxes) and question marks (?) represent unstudied molecules or biological processes in fish skeletal muscle. Absent molecules are indicated in black-dashed symbols. Symbols (i.e. molecules and boxes) colored in blue and green depict positive and negative modulators of fish muscle growth, respectively (Adapted from Fuentes et al. 2013).

### 1.1.7 Contractile apparatus

Muscle fiber protein machinery is organized into bundles of myofibrils which in turn are made up of repeated sarcomere units. Sarcomere represents the contractile unit that is

composed of thick myosin filaments intercalated with thin filaments, consisted of actin, troponin, tropomyosin, nebulin, tropomodulin and other molecules (Squire 1997, Figure 8). Myosin exists as a hexameric molecule, made of two heavy chains (MHC), two alkali chains (MLC1 and MLC3) and two 5,5'-dinitrobenzoic acid (DNTB)-removable regulatory light chains (MLC2), which form a long-coiled  $\alpha$ -helical tail with two heads. The myosin head that possesses an ATPase active site and creates cross-bridges with the actin molecules, is assembled by the N-terminal half of two MHCs and one pair of light chains, one regulatory and one alkali chain (Figure 9, Lowey 1994; Rayment et al. 1993; Huxley 2000).

The relative expression and composition of myosin light chains changes during teleost fish course of development. Different isoforms are encoded under developmental regulation or in response to hormonal treatment, ambient temperature and diet. Different larval and adult MLC2 isoforms have been detected in many fish species, such as Atlantic herring (Crockford & Johnston, 1993), plaice (Brooks & Johnston, 1993), African catfish (Huriaux et al. 1999) and turbot (Focant et al. 2003). Thyroid hormone orchestrated the developmental transition from the larval to the adult MLC2 isoforms in Japanese flounder (Yamano et al. 1994), while thyroid hormone elicited an age-dependent response in *mhc2* expression levels in gilthead sea bream (Moutou et al. 2001). Regulation of *mhc2* expression is influenced by the dietary lipid levels; *mhc2* transcript levels expression decreased with increasing lipid levels in Senegalese sole (Campos et al. 2010). Temperature induces changes in MLC proteins. Carp acclimated in low temperatures have a lower MLC3 content compared with the warm-acclimated fish (Crockford & Johnston 1990), whereas MLC2 isoforms proportion and composition fluctuated in Atlantic herring eggs incubated at increasing temperatures (Johnston et al. 1997). Moreover, the composition of MLC3 and MLC1 appeared constant during development with MLC3 expression prevailing. An excess of MLC3 to MLC1 was evident in larvae and adults of African catfish and turbot (Huriaux et al. 1999, Focant et al. 2000) whereas MLC3 proportion gradually rose after hatching as fish grew in Arctic charr (Martinez et al. 1991), barbell (Focant et al. 1992) and rainbow trout (Focant et al. 1994).

Chapter Σφάλμα! Χρησιμοποιήστε την καρτέλα "Κεντρική σελίδα", για να εφαρμόσετε το Heading 1 στο κείμενο που θέλετε να εμφανίζεται εδώ.

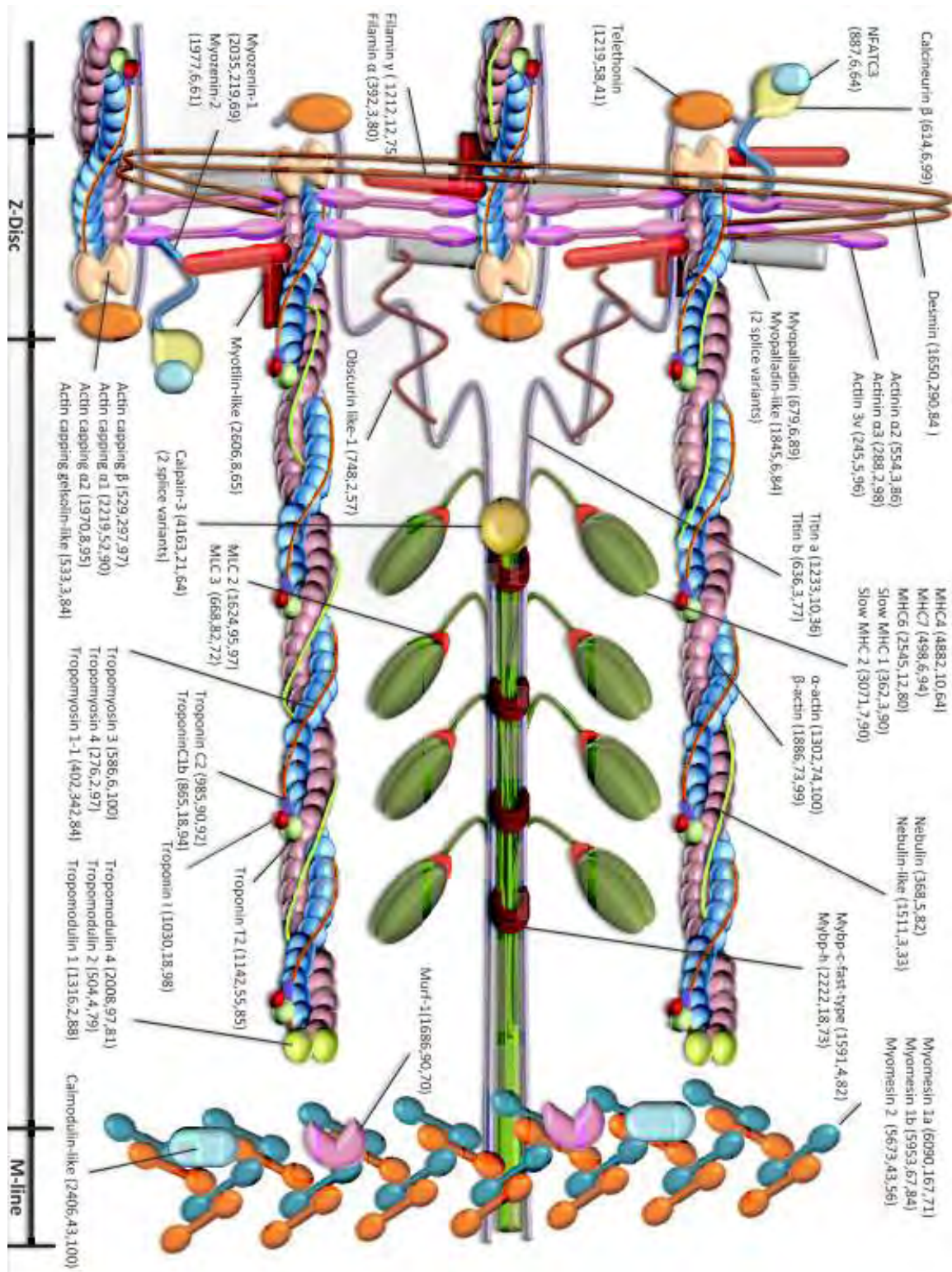

**Figure 8:** Representation of the proteins of the sarcomere assembly revealed by fast skeletal muscle transcriptome (Garcia de la serrana et al. 2012).

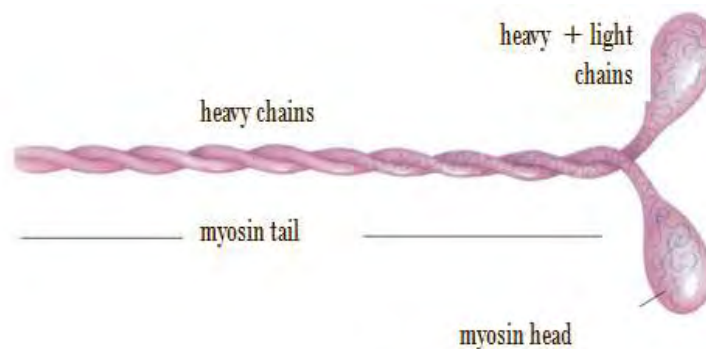

**Figure 9:** The myosin II molecule consists of two heavy chains and two pairs of light chains (called the essential and regulatory light chains). The heavy chains have globular head regions and long  $\alpha$ -helical tails, which coil around each other to form dimers.

### 1.1.8 Myosin light chain 2 in gilthead sea bream

Mechanical properties of the muscle fiber are modulated by myosin light chain 2 (MLC2) actions. Control of muscle contraction is exerted at the level of MLC2 phosphorylation by  $\text{Ca}^{2+}$ /calmodulin-dependent myosin light chain kinase (MLCK). This phosphorylation has a pronounced effect in actomyosin ATPase activity, increases the rate of force development and correlates with the maximal extent of isometric twitch tension (Sweeney et al. 1993; Szczesna et al. 2002).

*mlc2* gene family is composed of at least three genes, expressed in fast (*mlc2f*), cardiac and slow muscle, and smooth muscle and nonmuscle cells in vertebrates (Weeds & Lowey 1971; Emerson & Bernstein 1987). Distinct larval and adult isoforms have been described in teleost fish species characterized by small differences in the biochemical properties. Larval and adult MLC2 isoforms differ in molecular mass in plaice (Brooks & Johnston 1993) as well as in molecular mass and isoelectric point in Atlantic herring (Crockford & Johnston 1993), in flounder (Yamano et al. 1994), in African catfish (Huriaux et al. 1999) and in turbot (Focant et al. 2000). Developmental transition from larval to adult isoforms is expected to meet the functional requirements of the developing muscle to cope with the ever-going environmental species-specific demands.

MLC1, MLC2 and MLC3 have been characterized in gilthead sea bream white muscle. The expression of MLC1 and MLC2 was studied in early developmental stages (Moutou et al. 2005). *mlc2* and *mlc3* displayed a different age-related pattern of expression and *mlc2* expression was shaped by thyroid status (Moutou et al. 2001). *mlc2* transcripts were first

Chapter Σφάλμα! Χρησιμοποιήστε την καρτέλα "Κεντρική σελίδα", για να εφαρμόσετε το Heading 1 στο κείμενο που θέλετε να εμφανίζεται εδώ.

identified in gilthead sea bream larvae using Northern blot analysis to have different time windows of expression. *mlc2* appeared early in development; first *mlc2* expression was detected at the onset of somitogenesis at 20 hours post fertilization (hpf). Thyroid treatment affected *mlc2* expression in an age-dependent manner, with juvenile fish presenting increased expression levels whereas adult counterparts were not affected (Moutou et al. 2001).

In gilthead sea bream MLC2 is represented by two isoforms, A and B, exhibiting different expression patterns between tissues and during development (Sarropoulou et al. 2006). Deduced MLC2A and MLC2B amino acid sequences are 170 aa long and share high similarity, differing only in thirteen amino acids (Figure 10, Sarropoulou et al. 2005, 2006). MLC2A expression is restricted to the fast, glycolytic white muscle whereas MLC2B has a pleiotropic expression with transcripts detected in gills, liver, stomach among other tissues (Sarropoulou et al. 2006). Through *in situ* hybridization studies MLC2A expression was located to the white muscle apical germinal regions in pre-metamorphic larvae and to inter-fiber small cells (probably myogenic progenitor cells) scattered in the myotomes (Moutou et al. 2005).

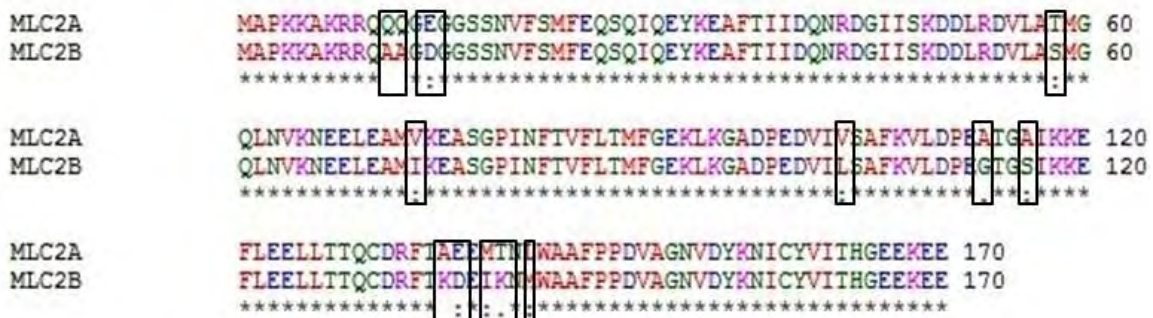

**Figure 10:** Alignment of the deduced amino acid sequences of both MLC2 isoforms in gilthead sea bream. Boxed amino acids distinguished isoform B from isoform A. Fully conserved residues are indicated by an “ \* ”; conserved groups of strongly similar properties are indicated by “ : ”; conserved groups of weakly similar properties are indicated by “ . ”.

At the molecular level, gilthead sea bream MLC2A mRNA undergoes alternative polyadenylation site selection to produce three different transcripts that possess 3' UTRs of different length (Sarropoulou et al. 2006). With respect to their sequence more information about their conformation and their regulation is still missing. Transcript spatio-temporal

expression during gilthead sea bream ontogeny as well as their contribution to the muscle gene expression network has to be further elucidated.

Analysis of the promoter region indicated that *mlc2f* is a muscle-specific gene, containing binding sites for the regulatory MRFs, which belong to the bHLH transcription factors. Six perfect E-boxes were found in which bHLH transcription factors can anchor and four sites for the MEF2 family of MADS box factors (Funkenstein et al. 2007). The myogenic bHLH transcription factors form heterodimers with E-proteins and activate the transcription of many skeletal muscle-specific genes (Wright 1991). MEF2 transcription factor regulates bHLH expression (Edmondson et al. 1992) and triggers the transcription of many skeletal muscle-specific genes (Gossett et al. 1989; Cserjesi and Olson 1991) often synergistically with bHLH factors (Funkenstein et al. 2007). These findings indicate the importance of muscle-specific regulation of MLC2 in the myogenetic process which arouses many questions about the time course, the players and the outcome of this regulation at each gilthead sea bream stage of development.

### *1.1.9 The 3' UTRs in gene regulation*

Gene regulation is mediated at the transcriptional level, tuning quantitatively and qualitatively gene transcription, as well as post-transcriptionally modulating the fate of mRNA molecules following their synthesis (Mignone et al. 2002). In eukaryotic cells transcription is orchestrated by several transcription factors, RNA polymerase and many *cis*-acting sequences such as promoters, enhancers, silencers and locus-control elements. Pre-mRNA molecules are synthesized in a modular structure and undergo modifications to produce the mature mRNAs. The functional mRNA molecule is composed of three parts; the 5' untranslated region, the protein coding region and the 3' untranslated region (Berg et al. 2002; Mignone et al. 2002). Post-transcriptionally control of mature mRNAs is mediated on additional levels including translational efficiency, mRNA stability and subcellular localization (Figure 11).

Dynamics of gene expression is further regulated during mRNA maturation and in particular with 3' UTR processing. Extreme conservation is observed in vertebrates 3' UTRs, adding to the significance of the untranslated regions to the post-transcriptional regulation (Siepel et al. 2005). A rich repertoire of basal and auxiliary protein factors consist the core molecular machinery that govern the simultaneous cleavage of the precursor mRNA molecule and the sequential synthesis of the poly(A) tail guided by specific sequences in the

3' UTR. The final outcome is the regulation of transcription termination. The modulation of RNA transcript abundance, stability, degradation, export to the cytoplasm, subcellular localization and translational efficiency is under the control of the alternative polyadenylation site selection mechanism (Colgan & Manley 1997; Mueller et al. 2013). Its "proteome" is composed of more than 80 proteins, linking alternative polyadenylation to other intracellular processes in human (Shi et al. 2009). In mammals 3' end formation is mediated by four multisubunit protein complexes; CPSF (Cleaveage and Polyadenylation Specificity Factor), CstF (Cleaveage Stimulation Factor), CFI and CFII (Cleaveage Factors I and II). The single subunit poly(A) polymerase (PAP) and RNA polymerase II (RNAP II) also exert a great role in 3' end processing. CPSF and CstF bind to specific sequences in 3' UTR. CPSF recognizes the canonical poly(A) signal AAUAAA upstream of the cleavage site whereas CstF binds to a U/GU-rich region found downstream. These two sequences and the distance between them specify the site of cleavage and poly(A) addition but also determine the strength of a poly(A) signal (Colgan & Manley 1997). Multiple poly(A) sites commonly occur in the genes of many species ranging from 10% in yeast (Nagalakshmi et al. 2008) to 50 % in humans (Tian et al. 2005).

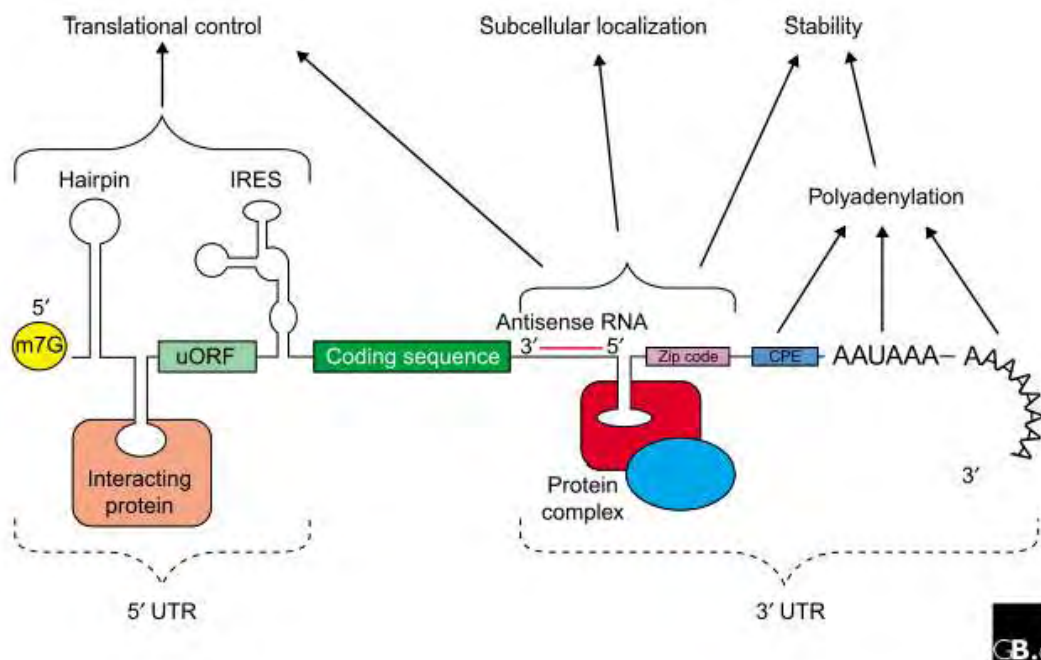

**Figure 11:** Gene expression of an mRNA molecule is a multi-step process. UTR, untranslated region; m7G, 7-methyl-guanosine cap; hairpin, hairpin-like secondary structures; uORF, upstream open reading frame; IRES, internal ribosome entry site; CPE, cytoplasmic polyadenylation element; AAUAAA, polyadenylation signal (Mignone et al. 2002).



The use of proximal or distal polyadenylation signals is tissue-specific in humans and is under the controlled synergy of the general polyadenylation trans-acting factors and the endogenous polyadenylation signals or other 3' UTR elements (Di Giammartino et al. 2011). The selection of a polyadenylation signal is also affected by the interplay of several other regulatory factors with the underlying 3' UTR sequence and the secondary structure that is formed. Apart from the consensus hexanucleotide, CstF binds to non-canonical proximal poly(A) sites which tend to be adjacent to U/GU-rich sequences downstream of the poly(A) site (Nunes et al. 2010). Other collateral modulating factors encompass gene/tissue-specific RNA-binding proteins (Di Giammartino et al. 2011), other non-coding proteins (Mignone et al. 2002) or miRNAs (Boutet et al. 2012) that bind to several *cis*-acting sequences located in the 3' UTR, like the AU-rich elements (AREs, Mignone et al. 2002). Shorter 3' UTRs skip regulation by binding of the aforementioned factors due to depletion of these sequences (Stark et al. 2005). In alternative polyadenylation the cleavage occurs 10-30 nts downstream of one of the multiple polyadenylation sites (AAUAAA) of a single transcript, contributing to enhanced protein diversity (Di Giammartino et al. 2011).

During zebrafish early development a tendency towards use of the distal sites and an overall increase in 3' UTR length was observed, while there was a tissue-specific pattern of 3' UTR length as development progresses (Ulitsky et al. 2012). With respect to alternative polyadenylation occurring in muscle tissue, longer 3' UTRs have been observed during differentiation of the C2C12 myoblasts into myotubes (Ji et al. 2009). It has been proposed recently that 3' UTR length heterogeneity differs upon myogenic determination, proliferation, differentiation, migration and fusion of precursor cells to form multinucleated muscle fibers; 3' UTR length is limited until the differentiation phase and then is increased again (Mueller et al. 2013).

3' end processing is coupled to translation of proteins govern by additional sequences in 3' uncoding region. In *Xenopus* oocytes poly(A) elongation is dictated by the hexanucleotide polyadenylation signal (AAUAAA) and the cytoplasmic polyadenylation element (CPE), a U-rich motif in a stage-specific manner. Cytoplasmic polyadenylation driven by the CPEs activates translation of maternal mRNAs during oocyte maturation whereas in mature oocytes translation is abolished (De Moor & Richter, 1999). Furthermore, CPEs regulate *c-mos* mRNA (CPE sequence UUUUAUAAUAAA) and cyclin A1 mRNA (CPE sequence UUUUAAUAAA) in *Xenopus* oocytes (Stebbins-Boaz & Richter et al.

1994; De Moor & Richter 1997) among other cell cycle regulators, like cyclins, wee1 and cdk2 (Mendez & Richter 2001).

Temporal and spatial control of gene transcription is another mechanism for protein production in discrete intracellular compartments in specific time-points. Localization of mRNA molecules assists in cell polarization, asymmetric distribution of cell fate determinants, neuronal maturation and embryonic patterning (López de Heredia & Jansen, 2003, Martin & Ephrussi, 2009). Localized gene translation is achieved by the simultaneous presence of components of the translational machinery and mRNAs incorporated in the ribonucleoprotein complexes (Mignone et al. 2002). mRNA has to be actively transported to the appropriate site, entrapped there and be protected by degradation. Active transport is possible along cytoskeletal filaments (Tekotte & Davis 2002). The cellular “address” of transcripts is dictated by *cis*-acting sequences in the 3' untranslated region. A 21-nts sequence, the RNA-transport signal, and an additional sequence, the RNA-localization region, both lying in the 3' UTR of myelin basic protein, guide its localization in the oligodendrocytes of the central nervous system in mouse (Ainger et al. 1997). Many examples of mRNA transcripts localization come from *Drosophila* early developmental stages in which transcripts are localized in the anterior or posterior pole of embryo. The morphogenetic gradient is determined by the translational activation of the Bicoid protein in the anterior pole and the Nos protein in the posterior pole. Although transcripts of both proteins are found in the bulk of the cytoplasm, the precise expression and/or translational activation/repression of each one in each pole is well orchestrated by the cooperation of auxiliary proteins (Bashirullah et al. 1999; Niessing et al. 1999).

From the birth of an mRNA to its processing, maturation, translation and finally to its death every single step of a transcript's life is finely regulated. mRNA transcripts are subject to molecular mechanisms governing its decay in canonical or noncanonical pathways with the assembly of many protein complexes (Garnaue et al. 2007). The “degradation code” involves the sequestering of RNA-binding proteins or miRNA-containing proteins in the *cis*-acting elements of 3' UTRs. It is the combination of the primary sequence and the secondary structure that controls mRNA degradation. The degradation rates of several mRNAs can vary over 100-fold (Wang 2002; Thomsen 2010) and depend on developmental cues (Alonso 2012) and external or internal stimuli (Tucker 2002).

In eukaryotic cells, degradation of most mRNAs is coupled with their deadenylation. In this pathway poly(A) tail is cleaved by deadenylases such as CCR4-NOT, PAN2-PAN3 or PARN and the mRNA is subject to decapping and 5'-3' decay or 3'-5' decay, each process orchestrated by auxiliary proteins. mRNA degradation can also occur in 3'-5' direction by the exosome followed by decapping by the scavenger-decapping enzyme DcpS (Liu et al. 2002). Noncanonical pathways of mRNA decay take place in other organisms as well. In yeast mRNA decay proceeds independently of deadenylation or is cleaved by endonucleases and then is subject to exonucleases. Another route is the nonsense-mediated decay (NMD) in which transcripts bearing premature terminating codons (PTCs) are detected and degraded. PTCs can arise as a result of faulty transcription, processing, translational initiation or extended 3' UTRs. Members of the NMD have been discovered in all eukaryotic organisms (Conti et al. 2005).

The ultimate mRNA fate is guided by the *cis*-acting elements located in the primary sequence of 3' UTR (Mignone et al. 2002). AU-rich elements (AREs) have been detected to control cytoplasmic deadenylation and promote mRNA degradation (Mignone et al. 2002; Peng et al. 1996). AREs are recognized and bound by HuR and AUF1 proteins regulating the stability of human eukaryotic translation initiation factor 4E (eIF4E, Topisirovic et al. 2009) and cell cycle regulators such as cyclin B and p21 (Lal et al. 2004) among other proteins (Kim & Gorospe, 2008). Other sequence signals triggering degradation are U-rich, CU-rich, GC-rich, poly(C), CA-rich and GU-rich (GRE) elements (Kim & Gorospe 2008; Vlasova et al. 2008).

Small sequences in the 3' UTRs are targeted by small-noncoding RNAs, miRNAs, shaping their expression (Fabian et al. 2010). miRNAs span 21nts in length and control the gene expression by base-pairing to the 3' UTRs to repress the target message by destabilizing it or inhibit its translation (Filipowicz et al. 2008). miRNAs interact with members of the ribonucleoprotein protein complex miRISC (Fabian et al. 2010) and lead mRNA to 5'-3' decay (Alonso 2012). *lin-4*, the first miRNA identified was detected in *C. elegans* (Lee et al. 1993) paved the way to the identification of many more miRNAs controlling gene expression in a tissue- and developmental stage-specific manner (Siomi & Siomi 2010). During *C. elegans* development *lin-4* miRNA modifies the gradient expression pattern of the heterochronic gene *lin-14* guided by a repeated sequence element in the 3' UTR. *lin-14* expression levels regulate the switch from early to late cell lineages (Wightman et al. 1993; Ha et al. 1996). *lin-4* and *lin-14* form a RNA duplex that hampers post-transcriptional processing, transport or translation of *lin-14* transcript.

Muscle gene expression network is also tuned by miRNA expression. Several miRNAs have been identified in muscle tissues and their expression coordinates the myogenic process, from proliferation to terminal differentiation of myoblasts. *miR-1*, *miR-133* and *miR-206* expression is strongly up-elevated during myogenesis in human myoblasts and C2C12 muscle cell line as well as they were found to have docking sites for Myogenin and MyoD (Rao et al. 2006). Their expression pattern and their key regulator role in the course of myogenesis are uniform in many species, such as common carp, zebrafish, mouse and pig (Chen et al. 2006, 2010; Huang et al. 2008; Mishima et al. 2009) reaching highest levels in the mature myotubes. Expression profiles of these three miRNAs follow development of common carp and their expression elevates with increasing age (Yan et al. 2012). *In vitro* studies revealed the muscle-specific genes miRNAs target, such as *myostatin* (DeSantis et al. 2008), *follicle-stimulating-like 1*, *utrophin* (Fstl1, Utrn, Rosenberg et al. 2006), *histone deacetylase 4* (HDAC4, Chen et al. 2006), *Pax7* (Chen et al. 2010), *c-Met* (Yan et al. 2009; Taulli et al. 2009), the *serum response factor* (SRF, Chen et al. 2006) and many genes involved in the cytoskeleton assembly, immunity and the energy metabolism of muscle cells (Johnston et al. 2009).

The secondary structure of the mRNA molecule allows or hampers the interaction with various ligands (Goodarzi et al. 2012). RNA structure and the formation of stems, loops or bulges may exert a catalytic role in mRNA processing during transcription and translation procedures as well as its degradation (Alonso 2012). Although information is still limited and often ambiguous, 3' UTR sequence, and the sequence downstream of the polyadenylation signals in particular, may favor its cleavage and the formation of the poly(A) tail (Zarudnaya et al. 2003). Conformational preferences of the mRNA sequence are taken into account in computational approaches that predict and visualize the secondary structure an mRNA molecule can adopt based on thermodynamic rules.

#### 1.1.10 Genomic resources in gilthead sea bream

The revolutionization of genomic and bioinformatic tools have scaled up the existing information in the quest of molecular markers to be used in selection and breeding programs of economically important farmed fish exhibiting high growth potential, such as the gilthead sea bream. In gilthead sea bream a genetic linkage map for assessing the syntenic relationships with tetraodon was the first to be generated (Franch et al. 2006). A whole-genome radiation hybrid (RH) map of 28 RH groups encompassing 440 markers was

constructed at the same time (Senger et al. 2006). It was the first time to reveal that the *mlc2* gene is well conserved in the course of evolution using comparative genomics of tetraodon, zebrafish, fugu, mouse and human genomes (Senger et al. 2006). Conserved syntenic blocks were identified in gilthead sea bream RH map, linking gilthead sea bream to tetraodon, medaka and three-spined stickleback genomes by using more than 800 EST and microsatellite sequences (Sarropoulou et al. 2007, 2008). Genomic collection was further enriched with 76 SNPs (Cenadelli et al. 2007) and another 29,895 ESTs, 575 SNPs and 899 microsatellite markers from 14 normalized tissue-specific cDNA libraries of Louro et al. (2010). The comparative bacterial-artificial chromosome (BAC) map subsequently generated was based on the existing karyotype information of three-spined stickleback and covered 75% of the gilthead sea bream genome (Kuhl et al. 2011). In total 74,877 ESTs were deposited in dbEST by July 2011 for this species (Garcia de la serrana et al. 2012).

SNPs and microsatellites genomic regions linked to growth traits have been achieved in gilthead sea bream. These polymorphic sites were identified in growth hormone gene correlated to fish growth performance (Almuly et al. 2000, 2005, 2008) and are described above. Polymorphisms were also identified in myostatin gene of gilthead sea bream and were successfully associated to growth traits. Polymorphic sites in *mstn-1* gene were linked to body weight, condition factor and fork length in broodstock, juvenile and adults (Sánchez-Ramos et al. 2012).

Gene expression profiling in distinct time points was possible through the development of an oligo-microarray transcriptome-based platform (Ferraresso et al. 2008). Moreover, the transcriptional landscape of genes involved in scale regeneration pathways (Vieira et al. 2011) as well as the hepatic transcriptome under stress-inducing conditions (Sarropoulou et al. 2005; Teles et al. 2013) was explored using the microarray technology. Three more transcriptome approaches focusing on different developmental stages or specific tissues added more pieces to the “genome” puzzle of this highly valuable species for the aquaculture sector. The expression profile of genes involved in the developmental processes changes dynamically with age and it remains to be fully elucidated based on the complete larval transcriptome dataset of 68,289 assembled contigs acquired with 454 pyrosequencing (Yúfera et al. 2012). 75% of the actively transcribed genes of metabolically and immunologically challenged tissues of gilthead sea bream were also obtained with 454 pyrosequencing technology (Calduch-Giner et al. 2013).

With the advent of deep sequencing technologies genes governing muscle growth and hence the muscle protein machinery can be thoroughly investigated. Transcripts of the cytoskeletal proteins (MLC2, MLC3, MHC, tropomyosin) were found to be highly abundant in the early gilthead sea bream larval stages to meet the ongoing demand for muscle growth (Sarropoulou et al. 2005). In accordance to the previous results in 1 and 4 dph larvae of the same species MLC1, MyoD, paralbumin, tropomyosin and sarcomeric creatine kinase proteins were largely expressed (Ferrareso et al. 2008). Muscle protein architecture was further revealed by two transcriptome studies. 5,655 unique genes containing 785 full-length cDNAs mapped to 344 KEGG (Kyoto Encyclopedia of Genes and Genomes) pathway maps, 177 microsatellites and 785 full-length cDNAs were obtained from fast skeletal muscle transcriptome (Garcia de la serrana et al. 2012) . With respect to the sarcomeric proteins interweaving the muscle proteome actinin, MLCs, MHC, titin, calpain-3, actin capping protein, myomesin, filamin, tropomodulin, nebulin, troponin C and myopalladin-like were represented with multiple isoforms (Figure 8, Garcia de la serrana et al. 2012). Also, approximately 700 genes regulating muscle-specific pathways, such as muscle cell differentiation, muscle development and contraction were identified in another transcriptome assembly (Calduch-Giner et al. 2013).

#### *1.1.11 Whole genome duplication in teleosts*

During the course of evolution teleost fish have undergone lineage-specific whole genome duplication (WGD) followed by an additional whole genome duplication in salmonids (Ohno 1970; Allendorf & Utter 1973) that generated multiple copies of genes and gave rise to the appearance of paralogues. The two duplicated copies are often located in different chromosomes or even in the same chromosome but the gene order has been altered due to intrachromosomal rearrangement or translocation events (Postlethwait et al. 2000). Duplicated gene copies may have alternate fates during evolution; they may partition functions of the ancestral loci (subfunctionalization) or they may evolve new functions (neofunctionalization) due to mutations leading to loss-of-function or beneficial mutations respectively (Force et al. 1999).

The four myogenic factors are a good paradigm of ancient paralogues created by the WGD in the lineage leading to vertebrates. Following the teleost-specific WGD the number of paralogues of the MRF genes was established in each species as a result of polyploidy or gene loss (Valente et al. 2013). Teleost *myoD* genes make a fine paradigm of these

evolutionary mechanisms between the separate teleost classes. *MyoD1* and *MyoD2* are pair of paralogues of the Acanthopterygii, yet only one *MyoD1* gene exists in Ostariophysii while salmonids have three paralogues; *MyoD1a*, *MyoD1b* and *MyoD1c* (Macqueen & Johnston 2008). It has been proposed that Acanthopterygii and salmonids *MyoD* paralogues have been preserved by subfunctionalization, displaying different expression profiles during ontogeny but at the same time recapitulating the expression repertoire of the single *MyoD1* (Valente et al. 2013).

Gene duplication events and divergence into paralogues have evolved the myosin family. MLC1, MLC2, MLC3 and troponin share the same evolutionary origin coming from a common ancestor (Holland et al. 1995). *mlc1* and *mlc3* genes share higher similarity than with *mlc2* and gene organization of *mlc2* differentiates remarkably; *mlc3* has emerged from gene duplication of *mlc1* while *mlc2* isoforms arose from paralogues of the *mlc2* gene in fish (Mugue & Ozernyuk 2006). Knowledge regarding *mlc2* gene structure and evolution is still fragmentary and even less is known about *mlc2* isoforms in teleost fish. Bioinformatic analysis revealed that fast skeletal *mlc2* contains seven exons in rainbow trout (*Oncorhynchus mykiss*, Krasnov et al. 2003) and in Javanese ricefish (*Oryzias javanicus*, Lee et al. 2012). In both *mlc2* genes 5' terminus was enriched in multiple copies of E-boxes and MEF-2 sites in which MRFs are recruited and regulate *mlc2* myogenic fate. Although both *mlc2* genes identified were reported to have a conserved structure in vertebrate evolution, phylogenetic relationships were not investigated.

## 1.2 Objectives of the study

The existing information on MLC2 in gilthead sea bream is the stepping stone for advancing research at different levels; the existence of two MLC2 isoforms raises questions on their evolutionary origin and the degree of conservation of gene organization and regulatory elements; the isolation of alternative transcripts coding for the same peptide makes MLC2A an excellent paradigm for studying the regulatory role of 3' UTRs; as part of the contractile apparatus MLC2 is expected to be regulated according to the myogenic program and its regulation should differentiate between the hyperplastic and hypertrophic modes of muscle growth; as a constituent of the final product, the fillet, MLC2 makes a good candidate marker of growth performance. The main objective of the present thesis is to radiate the knowledge on the regulatory myosin light chain 2 and trace its links with the post-embryonic myogenetic mechanisms in gilthead sea bream. Testing the validity of MLC2 isoforms as molecular markers of muscle development and growth under standard farming practices, in correlation with established growth markers is the ultimate objective.

More specifically, this PhD thesis focuses on the following:

- No genomic sequences are available for MLC2 isoforms. Taking advantage of the genomic resources available for gilthead sea bream, the organization of the genes encoding for the two MLC2 isoforms is studied and the syntenic relationships with model and non-model fish species are determined. The hypothesis that MLC2 isoforms are products of paralogous genes that have undergone subfunctionalization is tested by studying the expression patterns of the two isoforms a) during development, b) in primary muscle cell cultures, c) after the administration of growth hormone *in vivo* in juveniles. This approach offers primary data for the regulation of MLC2 isoform expression at different levels (cell vs organism), ages (larvae vs juveniles) and physiological statuses (hormonal manipulation) and provides evidence for possible subfunctionalization and for divergent evolution of their *cis*-regulatory elements.
- 3' UTRs hold a key role in gene expression and protein turnover. The biological significance of the three alternative transcripts of MLC2A is studied using bioinformatics tools and cell expression systems. The 3' UTRs of *mlc2a* alternative



transcripts are screened for domains that are known to contribute to transcriptional and post-transcriptional regulation, which are subsequently localized on the secondary structures of the 3' UTRs to be constructed. Results of bioinformatics analysis are coupled with studies in cell expression systems, where the functionality of 3' UTRs is investigated using luciferase reporter systems.

- MLC2A marks the newly-formed muscle fibers during development and its expression initiates at the beginning of somitogenesis. In order to further connect MLC2 isoform expression with muscle growth mechanisms i.e. hyperplasia and hypertrophy, MLC2 isoform expression patterns are explored during gilthead sea bream ontogeny and they are compared with changes in muscle cellularity. Early ontogeny is a period of intense hyperplastic events that alternate with hypertrophy. Total number of muscle fibers has been an established growth marker that MLC2 isoform expression levels are correlated with.
- The validity of MLC2 isoforms as growth markers is tested under standard production conditions. Hatchery stages are crucial in shaping growth potential at later stages. Furthermore, a great need for the development of reliable cost- and time-effective growth markers with predictive capacity has been repetitively expressed by the aquaculture sector. To this direction, MLC2 isoform validity as growth marker is tested in a) comparison of mesocosm vs intensive hatchery conditions and b) post-metamorphosis when growth depensation increases and wide size disparity is controlled through successive size-gradings.

*Chapter Σφάλμα! Χρησιμοποιήστε την καρτέλα "Κεντρική σελίδα", για να εφαρμόσετε το Heading 1 στο κείμενο που θέλετε να εμφανίζεται εδώ.*

---

*Chapter Σφάλμα! Χρησιμοποιήστε την καρτέλα "Κεντρική σελίδα", για να εφαρμόσετε το Heading 1 στο κείμενο που θέλετε να εμφανίζεται εδώ.*

---

## ***Chapter 2***

*Chapter Σφάλμα! Χρησιμοποιήστε την καρτέλα "Κεντρική σελίδα", για να εφαρμόσετε το Heading 1 στο κείμενο που θέλετε να εμφανίζεται εδώ.*

---

## **Chapter 2**

### ***Myosin light chain 2 isoforms in gilthead sea bream (*Sparus aurata*, L): a paradigm of divergent evolution***

#### **2.1 Introduction**

Fish is the most diverse group within the vertebrates with remarkable physiological, morphological and behavioral adaptations that supported the colonization of different marine and freshwater environments across the globe. The two successive rounds of whole-genome duplication early in vertebrate evolution and the subsequent teleost-specific genome duplication roughly 320-400 Myr ago are suggested to have produced the genomic raw material for the adaptation of teleost fish to a vast range of environments (Volf 2005). Although in some cases the serially duplicated genes in teleosts were lost, the retained duplicated genes (paralogues) may have undergone subfunctionalization and may exhibit divergent expression patterns (Force et al. 1999; Tan & Du 2002; Ikeda et al. 2007; Bower & Johnston 2010; Opazo et al. 2012). The current model proposes that the differential expression pattern of paralogues is the outcome of divergent evolution of *cis*-regulatory elements that ultimately direct subfunctionalization (Jimenez-Delgado et al. 2009; Goode et al. 2011). Thus, modifications in transcriptional regulation may presumably be the main driving force behind innovations in the vertebrate body plan (Aburomia et al. 2003; Levine & Tjian 2003).

Muscle formation and growth are complex processes well-conserved within vertebrates, with fish exhibiting a high myogenic potential throughout their life, a capacity lost in higher vertebrates (Goldspink 1972). The myogenic program, orchestrated by an array of myogenic factors, results in the synthesis and deposition of new proteins in new or pre-existing muscle fibers (reviewed by Valente et al. 2013). Myosin is a major sarcomeric protein formed by two heavy chains (MHCs) and four light chains (MLCs) combined in a long coiled  $\alpha$ -helical tail and two heads. Myosin light chain 2 (MLC2) is a regulatory component of the myosin molecule and indispensable for skeletal muscle development (Wang et al. 2007). In muscle contraction, MLC2 is phosphorylated by the  $\text{Ca}^{2+}$ /CaM-dependent myosin light chain kinase (MLCK) to influence the actin activated-ATPase activity and to contribute to force development and maximal extent of isometric twitch tension (Szczena et al. 2002 and references therein). In teleosts, different isoforms and/or

alternative transcripts of *mlc2* have been identified in carp (*Cyprinus carpio*), halibut (*Hippoglossus hippoglossus*), and gilthead sea bream (*Sparus aurata*) (Hirayama et al. 1998; Moutou et al. 2001; Galloway et al. 2006). Promoter analysis has also indicated the presence of two *mlc2* genes in rainbow trout (*Oncorhynchus mykiss*) (Krasnov et al. 2003). *Mlc2* transcript and isoform expression pattern appears to differ during development (Moutou et al. 2001; Galloway et al. 2006; Sarropoulou et al. 2006) and under different thermal regimes; in carp, alternative transcripts of myosin regulatory light chain generated by alternative poly(A) signal selection are subject to thermal regulation (Hirayama et al. 1998). Moreover, evidence suggests that *mlc2* may be a nutritionally regulated structural element. For example, in Senegalese sole (*Solea senegalensis*), *mlc2* was significantly down-regulated with increasing dietary lipid level (Campos et al. 2010). In Atlantic salmon (*Salmo salar*), *mlc2* was significantly up-regulated upon refeeding after a 32-day starvation period (Bower et al. 2009). Interestingly, subtractive hybridization analysis between non-transgenic and GH-transgenic coho salmon (*Oncorhynchus kisutch*) revealed increased expression of *mlc2* in transgenic individuals (Hill et al. 2000).

In gilthead sea bream, two isoforms of *mlc2* have been isolated (Moutou et al. 2001; Sarropoulou et al. 2006). *mlc2* isoform A (Accession number AF150904; Moutou et al. 2001) encodes for a 170 aa peptide and contains three potential polyadenylation signals in the 3' UTR. The three *mlc2a* transcripts generated by alternative polyadenylation site selection have been isolated and encode for the same peptide but differ in the length of their 3' UTRs (284bp, short; 788bp, medium; 876bp, long). Transcripts of isoform A were detected both in white and red muscle (Sarropoulou et al. 2006). *mlc2* isoform B (Accession number FG618631 unpublished) also encodes a 170 aa protein. Isoform B was detected in all tissues examined (red, white, smooth and cardiac muscle, kidney, liver, spleen, brain, gills, epidermis). *In situ* hybridization showed that isoform A expression marks the newly formed white fibers and post-metamorphosis is limited to small cells located in the inter-fiber space, most probably myogenic cells (Moutou et al. 2005).

MLC2A and MLC2B proteins have been highly conserved during evolution both in terms of amino acid composition and protein length; they share 92 % amino acid identity (Sarropoulou et al. 2006). This high similarity in amino acid composition is suggestive of considerable evolutionary constraint on the structure and function of myosin light chain 2, possibly due to the biological significance of building up the muscle. MLC2 exhibits differentiating regulatory action in smooth and striated muscle. Unlike striated muscle, the

initiation of contraction in smooth muscle is preceded by the phosphorylation of a serine residue at position 19 (Ser19) and a threonine residue at position 18 (Thr18) in MLC2 in the presence of ATP (Vicente-Manzanares et al. 2009). Although striated MLC2 is also phosphorylated by the Ca<sup>2+</sup>/CaM-dependent myosin light chain kinase (MLCK), this phosphorylation simply modulates contractile activity by increasing isometric force and the rate constant for isometric force redevelopment at low levels of calcium activation (Sweeney & Stull 1990). Four arginine residues present in smooth muscle MLC2 and absent from striated muscle MLC2 have been demonstrated necessary for the phosphorylation-dependent regulation (Yang & Sweeney 1995). None of the MLC2 isoforms in gilthead sea bream bears any of the residues required for phosphorylation of the smooth muscle, and their structure matches with their skeletal muscle expression.

The 5' flanking region of *mlc2a* has been isolated and contains a TATA box, four binding sites for the muscle-specific transcription factor myocyte enhancer factor-2 (MEF2), and six E-boxes, that are binding sites for members of the basic helix-loop-helix (bHLH) family myogenic regulatory factors (Funkenstein et al. 2007). Members of bHLH family are the four myogenic regulatory factors (MRFs), Mrf4, MyoD, myogenin, Myf5, transcriptional factors that drive stem cell commitment to a myogenic cell fate and terminal differentiation (Kassar-Duchossoy et al. 2004; Ferri et al. 2009). The MRFs owe their myogenic action to two highly conserved domains present in all members of the family; the basic region and the HLH domain (Weintraub et al. 1991). The MRFs exert their action upon dimerization with the ubiquitously expressed E-proteins and binding to the E-box (CANNTG) present in the regulatory sequences of muscle-specific genes (Tapscott 2005). MyoD is able to induce a variety of cells to differentiate to muscle cells (Tapscott 2005) and together with Myf5 have been shown to regulate skeletal muscle commitment, whereas myogenin promotes differentiation (Dedieu et al. 2002; Cao et al. 2006). MRF4 on the other hand is known to act both as a determination factor, expressed in a subset of myocytes in early somite, and as a differentiation factor involved in final myotube maturation (Zhang et al. 1995; Kassar-Duchossoy et al. 2004).

It is unknown how the two MLC2 isoforms are linked to the myogenic program and whether any type of subfunctionalization has been achieved during evolution. The present study a) identifies *in silico* the organization of the genes encoding the *mlc2* isoforms using comparative genomics analysis, b) investigates the pattern of *mlc2* isoform expression

during myogenesis and muscle growth by determining transcript abundance during development and in primary muscle cell cultures, and their regulation *in vivo* by growth hormone administration to fast growing juveniles. Comparison of expression patterns of the two isoforms at different stages of development and physiological status provide additional indications of the divergence of their *cis*-regulatory sequences. Two major MRFs, namely MyoD and myogenin, are included in the study as molecular indicators of the myogenic stage, for comparison with *mhc2* expression.



## 2.2 Materials and Methods

### 2.2.1 Bioinformatic analyses

#### 2.2.1.1 *mlc2a* and *mlc2b* sequences

Coding and deduced protein sequences of *mlc2a* and *mlc2b* isoforms were retrieved from NCBI GenBank (<http://www.ncbi.nlm.nih.gov>) for ten species in total; gilthead sea bream (*Sparus aurata*, Perciformes), European sea bass (*Dicentrarchus labrax*, Perciformes), Atlantic halibut (*Hippoglossus hippoglossus*, Pleuronectiformes), Nile tilapia (*Oreochromis niloticus*, Perciformes), orange-spotted grouper (*Epinephelus coiodes*, Percimorfes), and for the fully sequenced genomes; medaka (*Oryzias latipes*, Beloniformes), tetraodon (*Tetraodon nigroviridis*, Tetraodonitiformes), three-spined stickleback (*Gasterosteus aculeatus*, Gasterosteiformes), Atlantic cod (*Gadus morhua*, Gadiformes) and zebrafish (*Danio rerio*, Cypriniformes) (Table 1). In cases where the coding sequence was found in EST putative polypeptide was predicted using ORF Finder (<http://www.ncbi.nlm.nih.gov/>). Despite the small number of ESTs available for each organism the open reading frame of the predicted polypeptide was aligned against gilthead sea bream MLC2A or MLC2B with ClustalW and high similarity (ClustalW score >97 %) was found throughout the polypeptide.

#### 2.2.1.2 *mlc2a* and *mlc2b* genomic organization

*In silico* identification of the genomic organization was possible for seven species with known coding and genomic sequences. Genomic sequences of fish species with sequenced genomes (medaka, tetraodon, three-spined stickleback, Atlantic cod and zebrafish) were retrieved from the ensemble genome browser (<http://www.ensembl.org/index.html>). For the gilthead sea bream *mlc2a* the genomic sequence of the European sea bass was used due to lack of genome sequence information of gilthead sea bream. Identification of transcript splice sites/exon-intron junctions was carried out with the Spidey program at NCBI (<http://www.ncbi.nlm.nih.gov/IEB/Research/Ostell/Spidey/>, Wheelan et al. 2001).

### 2.2.1.3 Comparative genomics

Established syntenic relationships between European sea bass and gilthead sea bream via three-spined stickleback (Sarropoulou et al. 2008) allowed passing from European sea bass potential homologues to gilthead sea bream and three-spined stickleback homologues of both *mlc2* isoforms. Identification of potential homologues of *mlc2* isoforms in tetraodon and medaka was based on established syntenic relationships of gilthead sea bream with tetraodon and medaka (Sarropoulou et al. 2011). The BLAT aligning tool (<http://genome.ucsc.edu/FAQ/FAQblat.html>, Kent 2002) was used to find the homologous *mlc2a* and *mlc2b* zebrafish isoforms. BLAT was performed by using the parameters  $-q=dnax$  and  $-t=dnax$  with a score  $>80$ . BLAT was also used predict the percentage (%) of identity of homologues of both *mlc2* isoforms of three-spined stickleback, tetraodon, medaka and zebrafish to *mlc2* isoforms of gilthead sea bream. The query sequence was the coding sequence for *mlc2a* and *mlc2b* (AF150904 and FG618631 respectively).

### 2.2.1.4 Phylogenetic relationships

Cross-species gene conservation of the potential *mlc2* isoforms homologs was evaluated with phylogenetic analyses. ClustalW program (Thompson et al. 1994) was used for sequence alignments. Phylogenetic analysis of *mlc2* isoforms was performed with all ten fish in which both *mlc2* isoforms were identified; gilthead sea bream (*Sparus aurata*), European sea bass (*Dicentrarchus labrax*), Atlantic halibut (*Hippoglossus hippoglossus*), Nile tilapia (*Oreochromis niloticus*), orange-spotted grouper (*Epinephelus coioides*), medaka (*Oryzias latipes*), tetraodon (*Tetraodon nigroviridis*), three-spined stickleback (*Gasterosteus aculeatus*), Atlantic cod (*Gadus morhua*) and zebrafish (*Danio rerio*) (Table 1). Fast skeletal myosin light chain 2 was found in additional species that were included in the analyses; coelacanth (*Latimeria chalumnae*, ENSLACT00000002016), sea lamprey (*Petromyzon marinus*, FD716966), Florida lancelet (*Branchiostoma floridae*, XM\_002593491), amphioxus (*Branchiostoma belcheri*, AB035665), cat (*Felis catus*, S70434), human (*Homo sapiens*, L03785), rabbit (*Oryctolagus cuniculus*, X54042), rat (*Rattus norvegicus*, X00975), mouse (*Mus musculus*, U77943), chicken (*Gallus gallus*, M11030). The evolutionary history

was inferred using the Neighbor-Joining method (Saitou & Nei 1987). The optimal tree with the sum of branch length = 2.46763865 is shown. The percentage of replicate trees in which the associated taxa clustered together in the bootstrap test (1000 replicates) are shown next to the branches (Felsenstein 1985). The tree is drawn to scale, with branch lengths in the same units as those of the evolutionary distances used to infer the phylogenetic tree. The evolutionary distances were computed using the General Time Reversible method (Nei & Kumar 2000) and are in the units of the number of base substitutions per site. All positions containing gaps and missing data were eliminated. There were a total of 428 positions in the final dataset. Evolutionary analyses were conducted in MEGA5 (Tamura et al. 2011).

*Chapter Σφάλμα! Χρησιμοποιήστε την καρτέλα "Κεντρική σελίδα", για να εφαρμόσετε το Heading 1 στο κείμενο που θέλετε να εμφανίζεται εδώ.*

**Table 1:** List of the potential homologues of *mlc2* isoforms found in teleost species in the NCBI databases. EST: Expressed Sequence Tags, WGS: Whole Genome Shotgun. Putative polypeptides corresponding to missing cells were predicted using ORF Finder.

<i>mlc2</i> isoform	Species	Nucleotide accession numbers in NCBI	Database	MLC2 cds length (bp)	Protein accession numbers in NCBI	Database	MLC2 protein length (aa)
<i>mlc2a</i>	<i>Hippoglossus hippoglossus</i>	AJ488287	Nucleotide	513	CAD32553.1	Protein	170
<i>mlc2a</i>	<i>Oreochromis niloticus</i>	XM_003458741.1	Nucleotide (predicted)	513	XP_003458789.1	Protein (predicted)	170
<i>mlc2a</i>	<i>Gasterosteus aculeatus</i>	DW638371.1	EST	516	-	-	171
<i>mlc2a</i>	<i>Oryzias latipes</i>	AV669107.1	EST	513	-	-	170
<i>mlc2a</i>	<i>Tetraodon nigroviridis</i>	CR668003.2	Nucleotide	513	AAS90116.1	Protein	170
<i>mlc2a</i>	<i>Epinephelus coioides</i>	HQ207654.1	Nucleotide	513	ADZ76530.1	Protein	170
<i>mlc2a</i>	<i>Danio rerio</i>	NM_001004668	Nucleotide	513	NP_001004668.1	Protein	170
<i>mlc2a</i>	<i>Sparus aurata</i>	AF150904.1	Nucleotide	513	AAD54229	Protein	170
<i>mlc2a</i>	<i>Dicentrarchus labrax</i>	CABK01025858.1	Nucleotide	513	CBN81401.1	Protein	172
<i>mlc2a</i>	<i>Gadus morhua</i>	G0394170.1	EST	522	-	-	170
<i>mlc2b</i>	<i>Oreochromis niloticus</i>	XM_003442405	Nucleotide (predicted)	513	XP_003442453.1	Protein (predicted)	172
<i>mlc2b</i>	<i>Hippoglossus hippoglossus</i>	AJ488286.1	Nucleotide	513	CAD32552.1	Protein	170
<i>mlc2b</i>	<i>Danio rerio</i>	AF081462.1	Nucleotide	510	AAC32193	Protein	169
<i>mlc2b</i>	<i>Gasterosteus aculeatus</i>	BT028704.1	Nucleotide	516	-	-	171
<i>mlc2b</i>	<i>Oryzias latipes</i>	AY929065	Nucleotide	494	AAX34414.1	Protein	165
<i>mlc2b</i>	<i>Tetraodon nigroviridis</i>	CR667613	Nucleotide	512	-	-	170
<i>mlc2b</i>	<i>Epinephelus coioides</i>	FJ426123	Nucleotide	494	ACM41847.1	Protein	163
<i>mlc2b</i>	<i>Dicentrarchus labrax</i>	FM007892.1	EST	512	-	-	170
<i>mlc2b</i>	<i>Gadus morhua</i>	GW855926.1	EST	512	-	-	170
<i>mlc2b</i>	<i>Sparus aurata</i>	FG618631	EST	512	-	-	170

*Chapter Σφάλμα! Χρησιμοποιήστε την καρτέλα "Κεντρική σελίδα", για να εφαρμόσετε το Heading 1 στο κείμενο που θέλετε να εμφανίζεται εδώ.*

---

## 2.2.2 *Gene expression*

### 2.2.2.1 *Experiment 1: mlc2 expression patterns during development*

Pools of sea bream eggs and larvae were collected at 24, 27, 36, 43 hours post fertilization (hpf) and on 1, 4, 15, 24, 46 and 64 days post hatch (dph). Larvae were anaesthetized in 2-phenoxyethanol (1:5000, Sigma), frozen in liquid nitrogen and stored at -80 °C for further analysis. Three pool replicates were created in each sampling time. Total RNA was extracted using TRI Reagent (Sigma) following the manufacturer's protocol and stored at -80 °C until analysis. The differential expression during development of the two isoforms and of the alternative transcripts of isoform A was studied in collected eggs and larvae by real-time RT-PCR (Q-PCR).

### 2.2.2.2 *Experiment 2: mlc2 expression during myoblast proliferation and differentiation*

Sea bream primary muscle cell cultures were established according to the protocol described by Montserrat et al (2007). Briefly, white myotomal muscle (40 g) was excised from juvenile sea bream [2-6 g fresh body weight (BW)] under sterile conditions, minced and enzymatically digested with collagenase (Type Ia, Sigma) and trypsin (Sigma). Cells were resuspended and seeded in culture plates pretreated with a solution of poly-L-lysine (Sigma) and subsequently with glamine (Sigma). Cell culture was performed with this crude extract, with no selection of satellite cells, in complete medium at 22°C in air, in 6-well plastic plates (9.6 cm<sup>2</sup>/well, NUNC). Cell proliferation is dominant in the first four days of the culture and differentiation of mononucleated cells takes place up to 8 days before they start fusing to form mature fibres (Montserrat et al. 2007).

Cells were harvested at 24, 36, 48 hrs and on 3, 4, 8, 13 days after establishment. Total RNA was isolated from cell samples using the NucleoSpin RNA II Kit (Macherey-Nagel). All RNA isolation procedures were performed in accordance with the manufacturer's protocol.

The differential expression during development of the two *mlc2* isoforms and of the alternative transcripts of isoform A was studied in primary muscle cell cultures by real-time RT-PCR. MyoD2 and myogenin were also included in the analysis as myocyte proliferation and differentiation markers, respectively. Each culture experiment was repeated three times.

### 2.2.2.3 Experiment 3: Effect of growth hormone on *mlc2* expression

Fish were kept in 60-lt PVC tanks supplied with a continuous flow of aerated, filtered sea water. During the experiment the photoperiod was 14 h dark: 10 h light and the salinity and oxygen levels were recorded daily and were  $27.4 \pm 0.1$  °C,  $37.5 \pm 0.1$  ppt, respectively and oxygen was at saturation levels. Feed was offered once a day at 14.00 hours at a ration size of 2 % fresh BW per experimental tank. A commercial pelleted feed of 44.0 % protein, 20.0 % lipids, 15.8 % ENEO and 8.2 % ash was used.

Eighty juvenile sea bream of  $57.3 \pm 1.1$ g (mean  $\pm$  SEM) weight were randomly divided into four groups and acclimatized to the experimental circuit for two weeks prior to the commencement of the experiment. On day 0, ovineGH (NIADDK-oGH-15) dissolved in 0.9 % NaCl at 0.1, 1.0 and 10.0  $\mu$ g g<sup>-1</sup> BW, respectively was administered as a single i.p. injection to three groups of fish. The control group received an i.p. injection of 0.9 % NaCl. White muscle under the dorsal fin was dissected from five individuals per group on days 1, 2, 4 and 7 after oGH administration and was immediately frozen by immersion in liquid nitrogen. Fish were anaesthetized in 2-phenoxyethanol (1:5000, Sigma) before handling or sampling. Total RNA was extracted from muscle steaks using TRI Reagent (Sigma) and stored at -80 °C until analysis. The differential expression during development of the two isoforms and myogenin was studied in collected samples by real-time RT-PCR (Q-PCR).

### 2.2.3 Determination of gene expression

The expression levels of *mlc2* isoforms, *mlc2a* alternative transcripts, myogenin and myoD2 were determined by real-time RT-PCR (Q-PCR) method. Total RNA from each sample was reverse-transcribed using the AffinityScript multiple temperature reverse transcriptase (Stratagene). Reverse transcription reactions were performed in duplicate

and reaction products were pooled to a common sample. Lack of genomic DNA contamination was confirmed by PCR amplification of RNA samples in the absence of cDNA synthesis.

Reactions were performed in a 20  $\mu$ L volume containing cDNA generated from total RNA template, 300 nM each of specific forward (F) and reverse (R) primers (Table 2), and 17  $\mu$ L of Brilliant SYBR Green QPCR Master Mix (Stratagene). Matching oligonucleotide primers were designed using Primer3 Input 0.4.0 software (Whitehead Institute for Biomedical Research, Cambridge, MD, USA). MLC2 primers were designed to span the 3' UTR region of the transcripts. The only exception was Fw1 and Rv6 primers that were designed within the coding region to allow simultaneous amplification of all three MLC2A transcripts. Fw4 and Rv7 were designed within the 3' UTR common to both medium and long transcripts. Expression of the medium transcript was calculated from expression generated by Fw4Rv7 set of primers minus the expression generated by Fw7Rv10 set of primers spanning 3' UTR of the long transcript (Table 2, Figure 1). The amplification protocol used was as follows: initial denaturation and enzyme activation for 7 min at 95  $^{\circ}$ C, followed by 40 cycles of 95  $^{\circ}$ C for 30 s and 60.5  $^{\circ}$ C for 1 min. Each assay was performed in duplicate. Six-point standard curves of a five-fold dilution series (1:5-1:1000) from pooled cDNA was used to estimate PCR amplification efficiency.

A series of housekeeping genes (*EF1 $\alpha$* ,  *$\beta$ -actin*, *tubulin- $\alpha$* , *RPL13a*, *RPS18*) were validated for use in different developmental stages and physiological conditions and were rated using the geNorm VBA applet (Vandesompele et al. 2002). In each experiment, the normalization factor was calculated as the geometric mean of the two or three most stably expressed housekeeping genes (exp. 1, EF1a; exp. 2, EF1a; exp. 3 RPS18, RPL13a, b-actin).



**Table 2:** Primers used for real-time PCR gene expression (Q-PCR) analysis. Fw and Rv refer to forward and reverse primers, respectively.

<b>Transcript</b>	<b>Accession number</b>	<b>Primer</b>	<b>Sequence (5'-3')</b>	<b>Product size (bp)</b>
MLC2A – all transcripts	AF150904	Fw1	GCCCCATCAACTTCACCGTCTTT	188
		Rv6	GGTTGGTCATCTCCTCAGCGG	
MLC2A – long + medium transcripts	*	Fw4	TCTCTGTCCCTGCCTCTTGT	201
		Rv7	GGCCGCTTACTTGTTTGAAG	
MLC2A – long transcript	*	Fw7	GGCATGACAGGAAAAGTTGC	179
		Rv10	TGAAAACAGGAGAGAAACAGC	
MLC2B	FG618631	Fw	TCCCTTTGCTATTCTGCCTTC	180
		Rv	AAATCAGCCCTATTCCCCATA	
Myogenin	EF462191	Fw	CAGAGGCTGCCCAAGGTG	181
		Rv	CAGGTGCTGCCCGAACTGGGC	
MyoD2	AF478569.	Fw	ACGAGTCCAGGAGAAGCA	200
		Rv	CGTAGATGCTGTTGGGTTCA	

\* Accession number does not exist in NCBI (<http://www.ncbi.nlm.nih.gov/>) for the gene.

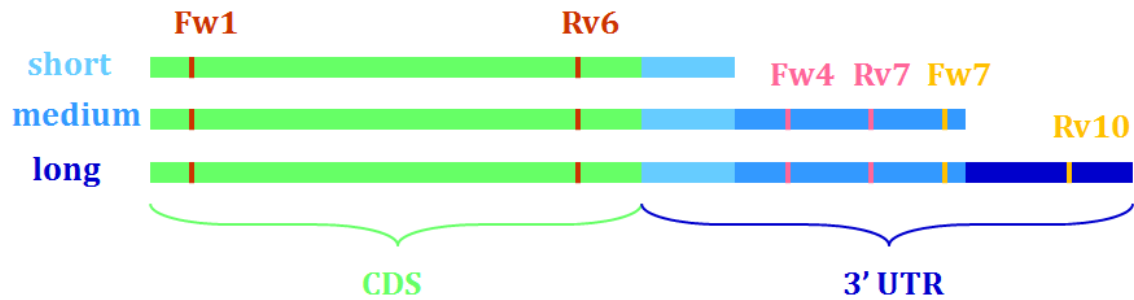

**Figure 1:** Schematic representation of primer binding that were designed to determine gene expression of *mlc2a* alternative transcripts. Fw1 and Rv6 primers were designed within the coding region to allow simultaneous amplification of all three MLC2A transcripts. Fw4 and Rv7 were designed within the 3' UTR common to both medium and long transcripts. Expression of the medium transcript was calculated from expression generated by Fw4Rv7 set of primers minus the expression generated by Fw7Rv10 set of primers spanning 3' UTR of the long transcript. short, medium, long represent short, medium and long transcripts respectively.

#### 2.2.4 Statistical analyses

Differences among time points of myocyte differentiation and development were analyzed using one-way analysis of variance (ANOVA). Differences in the expression levels of target genes after GH administration were evaluated using two-way ANOVA with GH dose and sampling time as factors. When the F test was significant, means were compared using Tukey's pairwise test. Gene expression data were square-root transformed to meet the assumptions of normality and/or homogeneity. Differences were considered significant at  $P < 0.05$  level. All statistical analyses were performed using SPSS software (version 19).

## 2.3 Results

### 2.3.1 Bioinformatic analyses

#### 2.3.1.1 Identification of homologous *mlc2* isoforms in teleosts

Two isoforms of myosin light chain 2 were determined in ten teleost species in total; gilthead sea bream, European sea bass, Atlantic halibut, Atlantic cod, Nile tilapia, three-spined stickleback, medaka, tetraodon, orange-spotted grouper and zebrafish. *Mlc2a* coding sequence (cds) or open reading frame (orf) ranged from 513-522 bp and MLC2A protein from 170-172 aa between species. *Mlc2b* cds covered from 494-516 bp and MLC2B protein from 163-172 aa in the different organisms (Fasta files 1 & 2). The database that sequences came from and their accession numbers in GenBank are indicated in Table 1.

#### 2.3.1.2 *Mlc2a* genomic organization and establishment of syntenic relationships

*Mlc2a* gene exon-intron junctions and the length of intron spanning sequences were estimated for gilthead sea bream, European sea bass, medaka, tetraodon, three-spined stickleback, Atlantic cod and zebrafish. *Mlc2a* gene contains 5 exons in all organisms examined (Figure 2). For the gilthead sea bream *mlc2a* the genomic sequence of the European sea bass – a species phylogenetically close to gilthead sea bream (Kuhl et al. 2011) – was used due to lack of genome sequence information of gilthead sea bream. Zebrafish *mlc2a* gene has a different structure from that of the other species. Zebrafish exon I and II are separated by a short intron, and the second intron is of approximately equal length (443 bp and 459 bp respectively). Atlantic cod *mlc2a* gene structure is similar to the other teleosts, although the genomic sequence of the Atlantic cod is still incomplete. All *mlc2a* isoforms were located in different chromosomes (Figure 2).

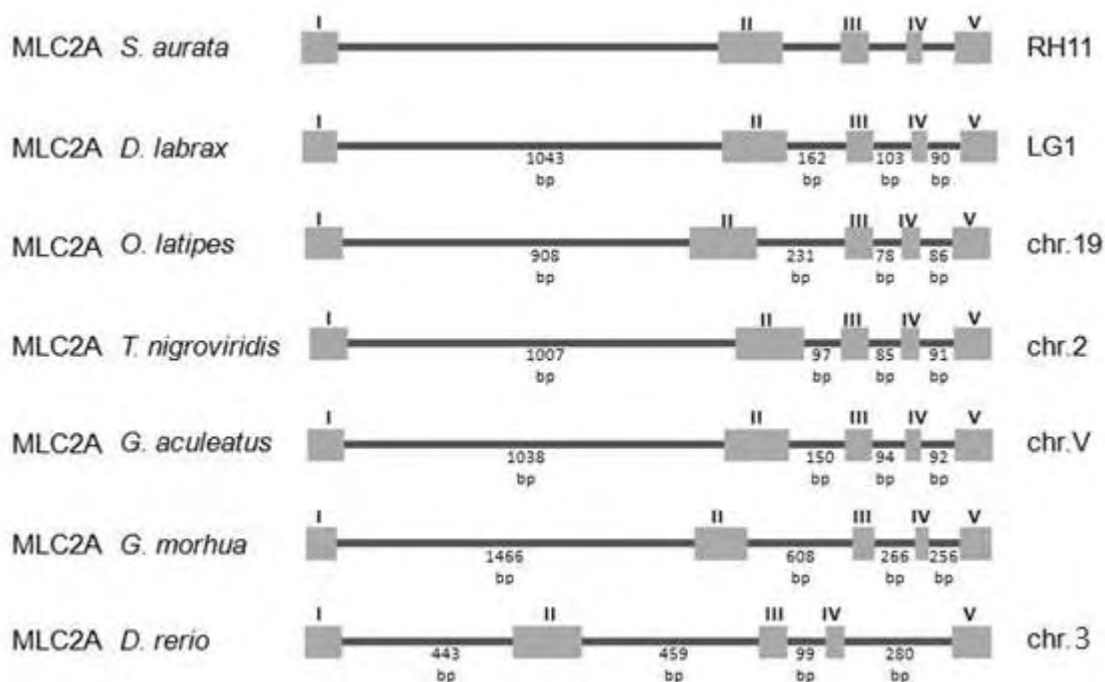

**Figure 2:** Comparative drawing illustrating the predicted exon-intron organization of *mlc2a* gene across the species under investigation using the Spidey program. Latin letters I-V indicate the exons. Numbers below the introns indicate the intron lengths. For gilthead sea bream the genomic sequence of European sea bass was used due to lack of genomic sequence information for this species and the length of the intron spanning sequences of gilthead sea bream could not be predicted.

MLC2A protein is encoded by European sea bass FQ310507.3 shotgun sequence which is located in LG1. European sea bass LG1 corresponds to chromosome V of stickleback and radiation hybrid group (RH) 11 of the gilthead sea bream (Sarropoulou et al. 2008). Gilthead sea bream RH11 corresponds to chromosome 2 of tetraodon and chromosome 19 of medaka (Sarropoulou et al. 2011). BLAT analysis was used to localize to chromosome *mlc2a* homologue in zebrafish, as described for the calcium channel b2 subunit localization to teleost chromosomes (Ebert et al. 2008). Zebrafish *mlc2a* is mapped on chromosome 12 (Table 3). Percentage of similarity of the homologous *mlc2* isoforms to gilthead sea bream's *mlc2* isoforms is indicated on Table 3.

**Table 3:** *In silico* identification of potential homologues of both *mlc2* isoforms in teleost species under study. Homologues identity to the two *mlc2* isoforms of gilthead sea bream was predicted with BLAT.

Organism	<i>mlc2a</i>		<i>mlc2b</i>	
	Location	Identity (%)	Location	Identity (%)
European sea bass	LG1	-	LG8	-
three-spined stickleback	V	95.5	XI	93.7
gilthead sea bream	RH11	-	RH24	-
tetraodon	2	95.1	3	94.3
medaka	19	94.8	8	95.3
zebrafish	12	91.2	3	91.5

### 2.3.1.3 *Mlc2b* genomic organization and establishment of syntenic relationships

*Mlc2b* gene is composed of six exons (Figure 3) in all teleost species examined. Like *mlc2a*, intron I is the largest intron (1.646 bp) between the first and the second exons. In contrast to *mlc2a*, the exon organization in *mlc2b* is slightly different between species, indicating evolutionary differences in the two *mlc2* isoforms. Zebrafish *mlc2b* gene architecture is different from that of other teleosts. The first intron of Atlantic cod's *mlc2b* could not be precisely drawn since genomic sequence coding for *mlc2b* is aligned in several contigs in the first draft sequence and assembly of this species.

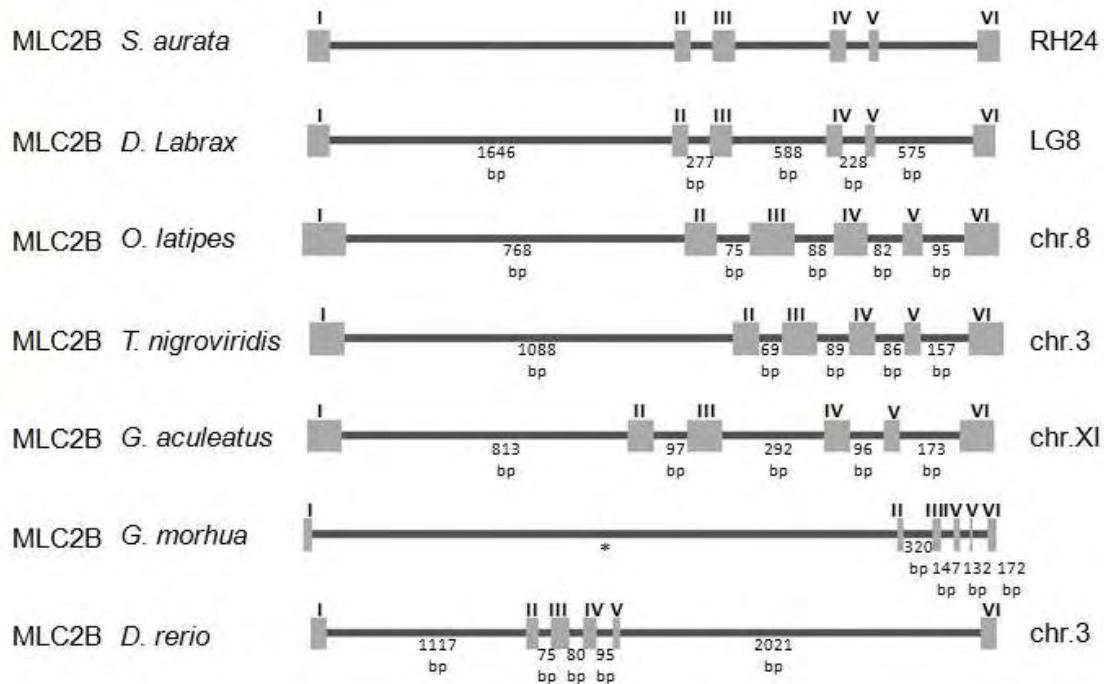
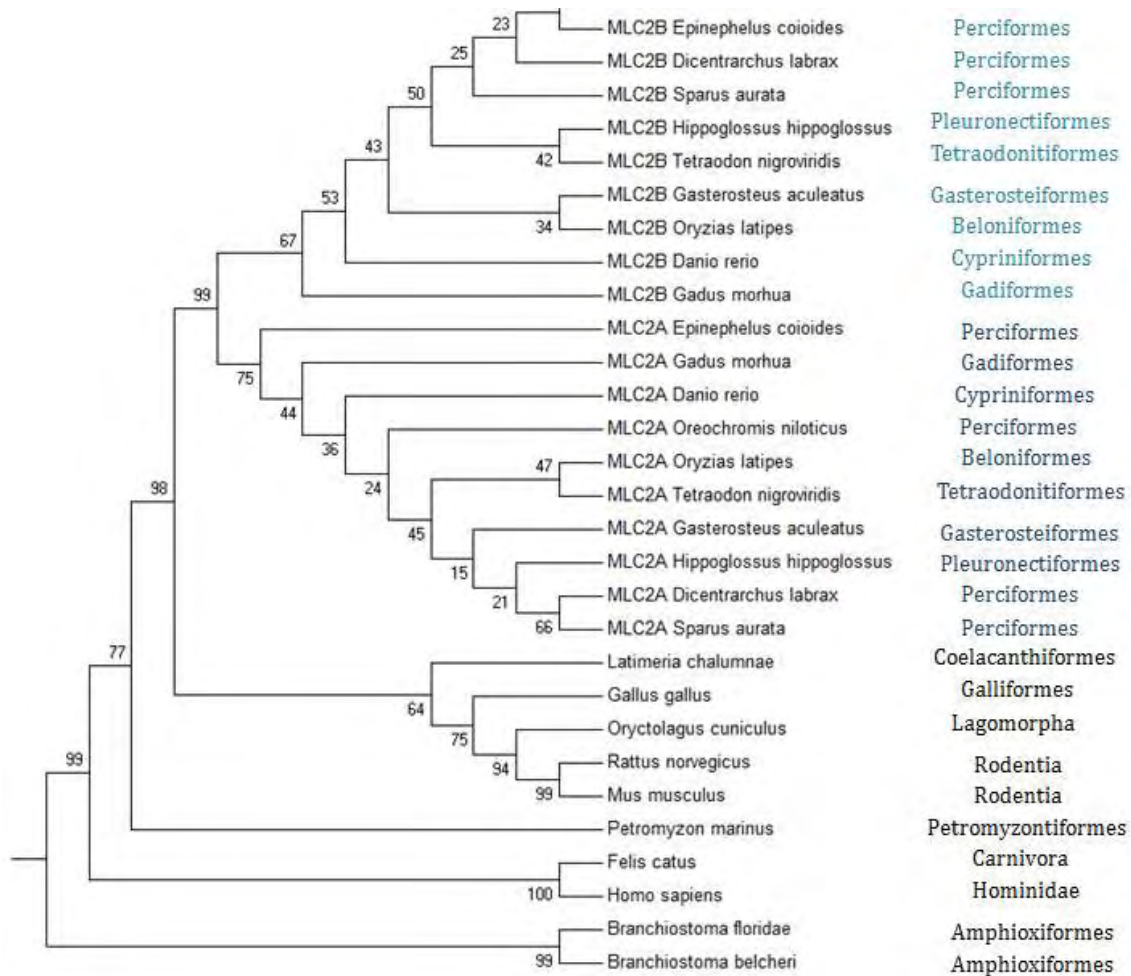

**Figure 3:** Comparative drawing illustrating the predicted exon-intron organization of *mlc2b* gene across the species under investigation using the Spidey program. Latin letters I-V indicate the exons. Numbers below the introns indicate the intron lengths. For gilthead sea bream the genomic sequence of European sea bass was used due to lack of genomic sequence information for this species and the length of the intron spanning sequences of gilthead sea bream could not be predicted. For Atlantic cod intron I is not drawn to scale and is marked with an asterisk to indicate the large region of ambiguous base calling in the NCBI database.

MLC2B protein is encoded by European sea bass FM007892.1 EST which is located in LG8. European sea bass LG8 corresponds to chromosome 11 of three-spined stickleback and RH24 in the gilthead sea bream (Sarropoulou et al. 2008). RH24 of gilthead sea bream corresponds to tetraodon chromosome 3 and three-spined stickleback chromosome 11 (Sarropoulou et al. 2011). BLAT analysis mapped zebrafish *mlc2b* on chromosome 3 (Table 3).

#### 2.3.1.4 Phylogenetic relationships

For *mlc2a* and *mlc2b* coding sequences human *mlc2* was used as an outgroup (Figure 4). The node closest to outgroup tied two large clusters, one formed exclusively by *mlc2a* and the other by *mlc2b* isoforms. Within the *mlc2a* cluster, zebrafish and Atlantic cod (Cypriniformes and Gadiformes) form a sister group to all the other orders of fish with the exception of orange-spotted grouper. Within the *mlc2b* cluster, Atlantic cod appeared as sister group to a clade comprised by zebrafish and the other orders of fish. Within *mlc2b* cluster, species belonging to the order Perciformes (Nile tilapia, orange-spotted grouper, European sea bass, gilthead sea bream) comprised one large group with low bootstrap values, unlike *mlc2a* cluster. In the latter, gilthead sea bream and European sea bass *mlc2a* comprise one group. In *mlc2b* cluster, European sea bass *mlc2b* appeared as a sister group to the group comprised of species of the order Perciformes.



**Figure 4:** Phylogenetic relationships among ten fish species coding for *mlc2a* and *mlc2b* genes. The phylogenetic tree was constructed using the Neighbor-Joining method with MEGA version 5 (Tamura et al. 2011). Sequence accession numbers are given in Table 1 and in paragraph 2.2.1.4 . Bootstrap values are indicated above the branches.

## 2.3.2 Gene expression

### 2.3.2.1 Expression of *mlc2* transcripts during development

*Mlc2* expression was determined in pre-hatched embryos and larvae up to post-metamorphosis in order to cover the phases of somitogenesis, embryonic myogenesis and stratified hyperplasia dominating the early development (Rowlerson et al. 1995). In agreement with previous data (Moutou et al. 2001), *mlc2a* expression marked the



embryonic myogenesis (Figure 5A). A major increase was observed between 27 and 36 hpf, preceded by a peak in myogenin expression. *Mlc2a* expression increased continuously up to metamorphosis, and decreased thereafter. *Mlc2b* expression remained at very low stable levels during the embryonic phase and started to rise from 4 dph onwards and reached the highest levels post-metamorphosis. *MyoD2* exhibited the highest expression at 36 hpf. After that point, it had a constant, stable expression during development (Figure 5A). Myogenin was expressed throughout development and exhibited two peaks of expression at 27 hpf and on 46dph. The peak at 27 hpf was followed by a rapid increase in *mlc2a* transcription while the peak on 46 dph coincided with peaked *mlc2a* transcription and a major increase in *mlc2b* expression (Figure 5A).

From the three alternative transcripts of *mlc2a*, *mlc2a*-short comprised 72-90 % of the cumulative *mlc2a* expression (Figure 5B). The *mlc2a*-medium contributed the least to the cumulative *mlc2a* expression (5.8 % on average). The average abundance of *mlc2a*-long was double (11.7 % on average) than that of the *mlc2a*-medium. The expression of all three alternative transcripts of *mlc2a* followed the same general trend, peaking at differentiation and declining thereafter (Figure 5B).

Chapter Σφάλμα! Χρησιμοποιήστε την καρτέλα "Κεντρική σελίδα", για να εφαρμόσετε το Heading 1 στο κείμενο που θέλετε να εμφανίζεται εδώ.

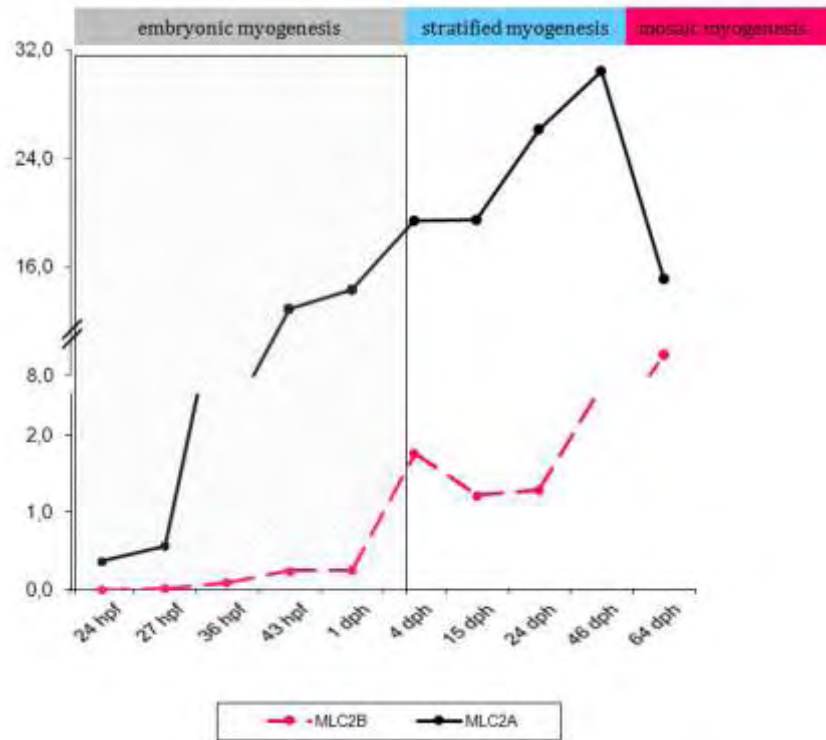

A)

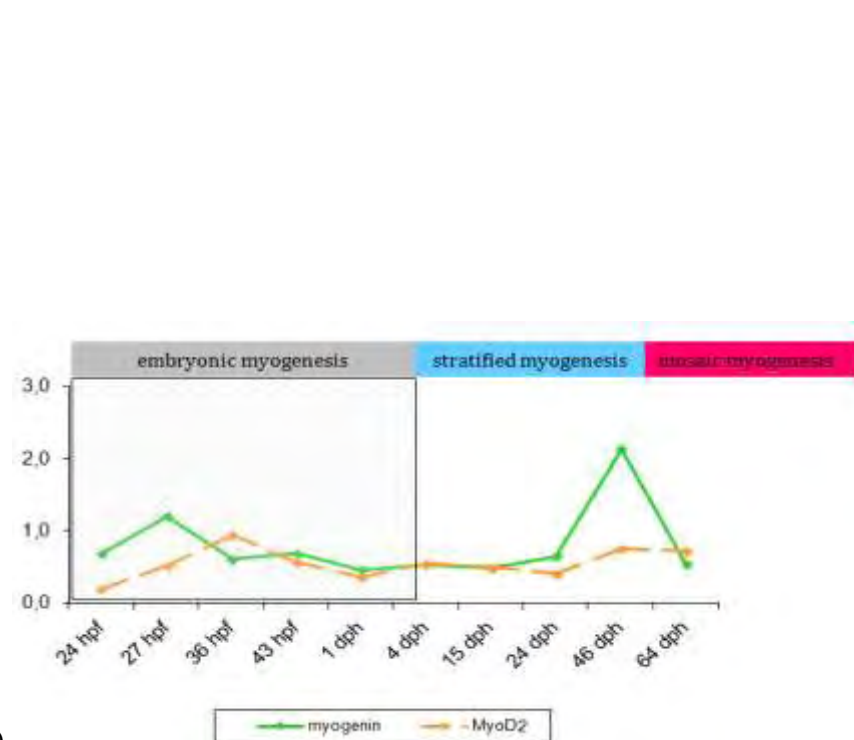

B)

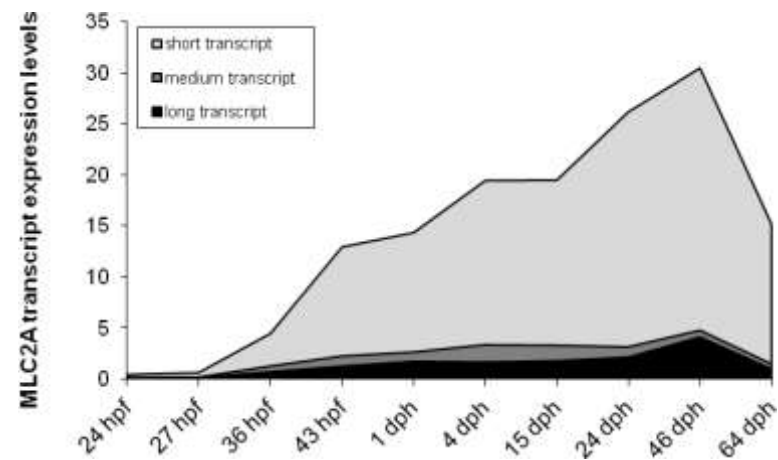

C)

**Figure 5:** Expression patterns of (A) *mlc2* isoforms, (B) myogenin and *myoD2* and (C) *mlc2a* transcripts, during embryogenesis and in developing larvae of gilthead sea bream.

### 2.3.2.2 Expression of *mlc2* transcripts and myogenic factors during myoblast proliferation and differentiation

Primary muscle cell cultures from gilthead sea bream retain their mononucleated phenotype during the proliferation stage and subsequently they start fusing to form small myotubes and subsequently large myotubes (Montserrat et al. 2007). *Mlc2a* transcript levels remained low in the first three days in culture (Figure 6A). From day 4 onwards myocytes entered the differentiation phase, which was marked by a gradual increase in myogenin expression (Figure 6B). *Mlc2a* expression also increased significantly ( $P<0.001$ ) and peaked on day 8 along with myogenin. A high correlation was observed between *mlc2a* and *myogenin* ( $R=0.784$ ;  $P<0.01$ ). *Mlc2b* exhibited a similar expression pattern, yet at significantly lower levels ( $P<0.001$ ) compared with *mlc2a*. *MyoD2* was expressed at low levels and contrary to the *mlc2* expression pattern, it exhibited a continuous gradual increase throughout the proliferation and differentiation phase (Figure 6B).

*Mlc2a* was the dominant isoform in differentiating myocytes. At each sampling point, *mlc2a*-short comprised 85-90 % of the cumulative *mlc2a* transcripts (Figure 6C). The expression of the three alternative transcripts followed the same general trend (Figure 6C) exhibiting the highest expression at differentiation.

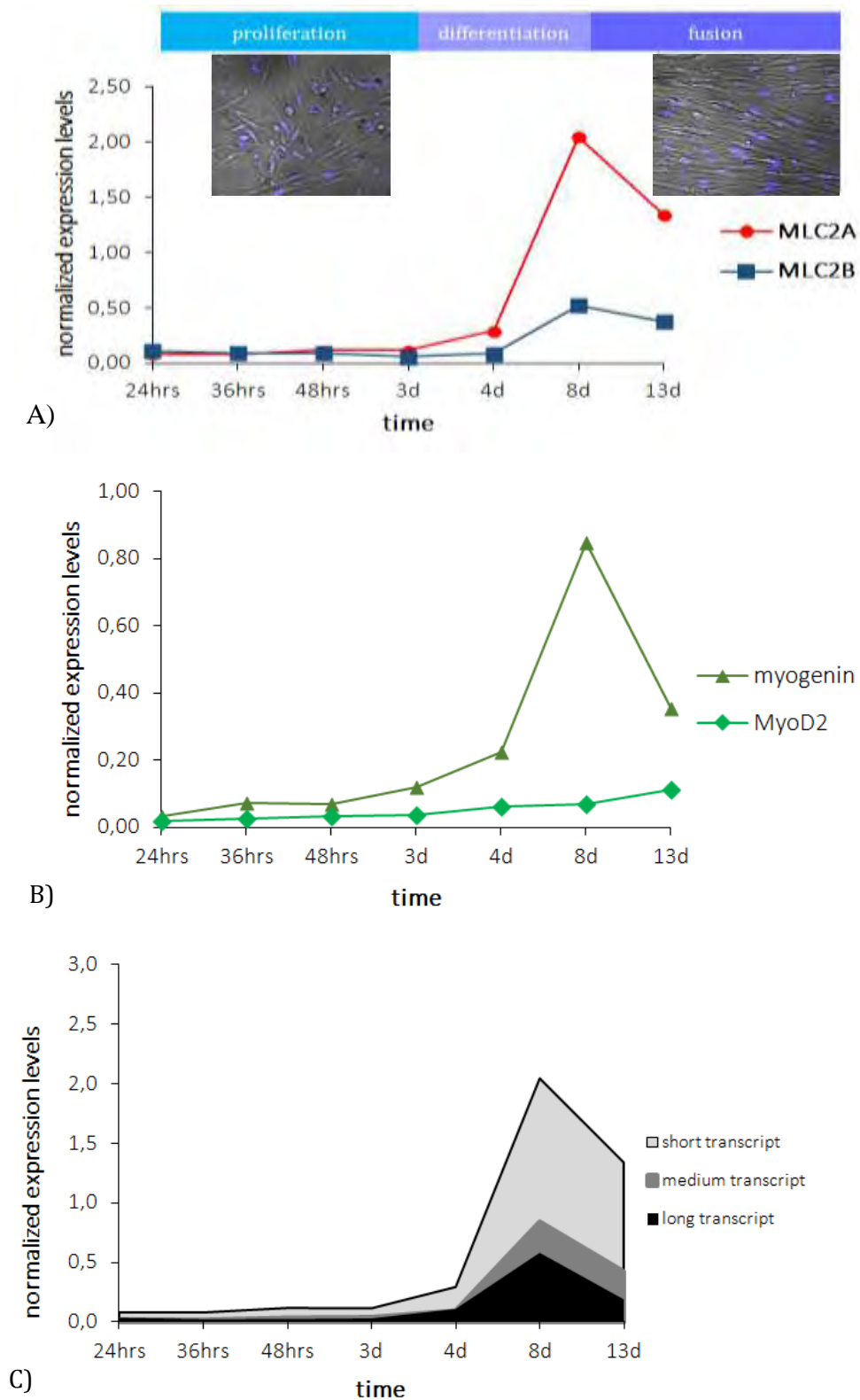

**Figure 6:** Expression patterns of (A) *mlc2* isoforms, (B) myogenin and *myoD2*, and (C) *mlc2a* alternative transcripts in primary muscle cell cultures of gilthead sea bream. Values represent the mean of normalized expression in three independent cultures.

### *2.3.2.3 Effect of growth hormone on *mlc2* and myogenin expression*

Expression levels of *mlc2a* were higher in the white muscle of oGH-treated sea bream compared with the control group already on day 1 post-administration and significantly elevated on day 2 ( $P=0.023$ , Figure 7A). *Mlc2b* was significantly elevated in all oGH-treated groups only on day 7 following administration ( $P=0.028$ , Figure 7B). The effect of oGH on *mlc2* expression was not dose dependent. Unlike *mlc2a*, myogenin expression that were seen to follow *mlc2a* expression in developing larvae (Figure 5) and primary muscle cell cultures (Figure 6) was not significantly affected by oGH administration (Figure 7C).

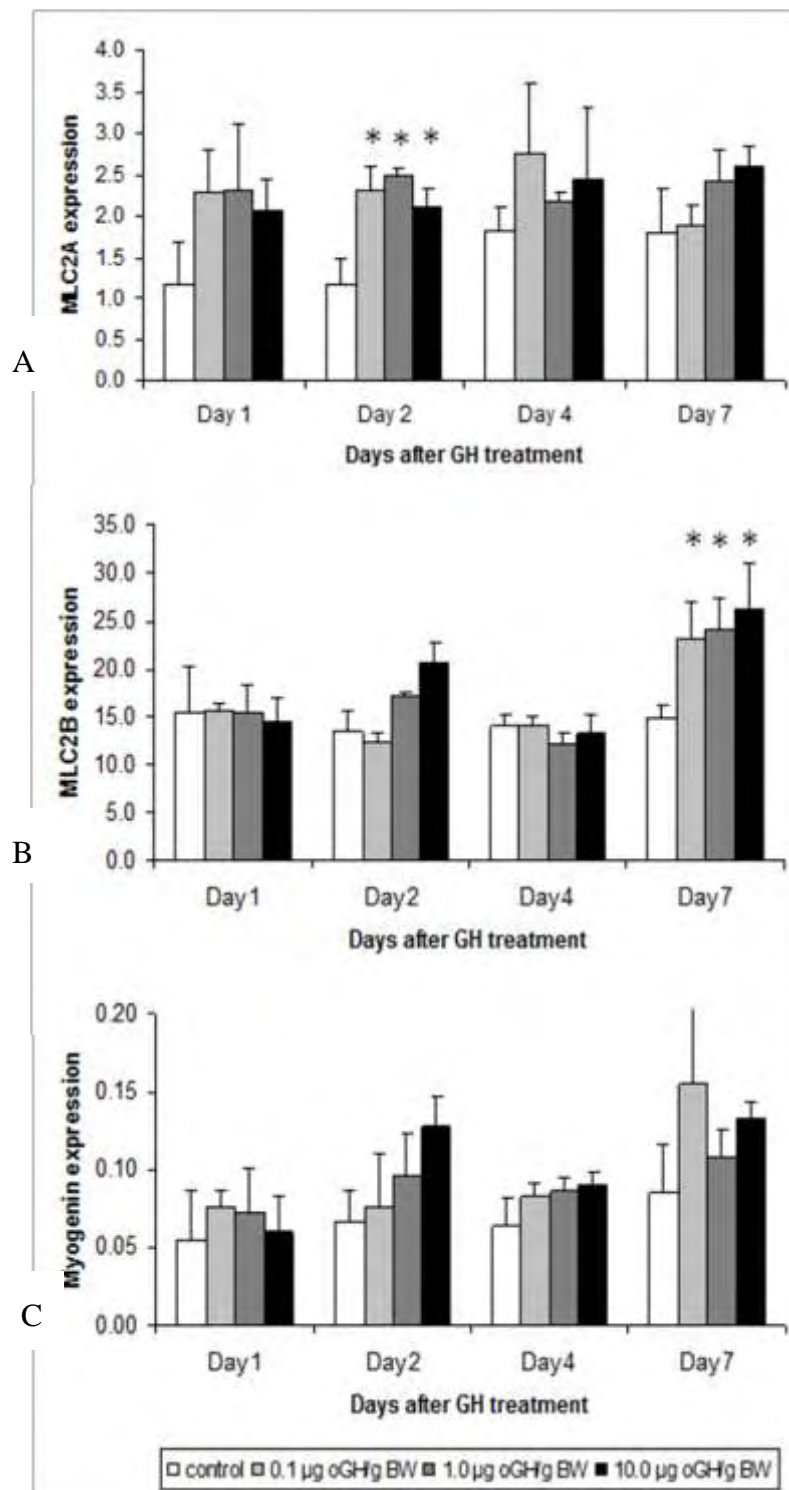

**Figure 7:** Expression patterns of *mlc2a* (A), *mlc2b* (B) and myogenin (C) in the white muscle of juvenile gilthead sea bream 1, 2, 4, and 7 days after administration of single dose of 0.1, 1.0 and 10.0 µg of ovine GH/ g fresh BW. Asterisks indicate significant difference ( $P < 0.05$ ) from the control individuals.

## 2.4 Discussion

The results of the present study reveal that the two isoforms of *mlc2* identified in the gilthead sea bream are duplicated genes (paralogues) that have probably undergone subfunctionalization as revealed by their divergent expression patterns during myogenesis in primary muscle cell cultures and in developing larvae, and after administration of growth hormone to juveniles. The expression of the two isoforms is age-dependent. MLC2A was the first to appear in development and remained the dominant isoform up to metamorphosis whereas MLC2B was the prevailing isoform in juveniles. Differentiation of primary muscle cells in culture was marked by an up-regulation of myogenin and MLC2A, providing an additional plausible link between MLC2 expression and myogenic programming.

MLC2 isoforms are products of different genes and on the gilthead sea bream radiation hybrid map are located on groups RH11 and RH24. Two separate genes coding for the two *mlc2* isoforms have also been identified in rainbow trout (Krasnov et al. 2003). However, no coding sequences for rainbow trout *mlc2* are available in GenBank and therefore they were excluded from the current analysis. The evolutionary history of the myosin gene family reveals that the teleost-specific whole genome duplication has led to the appearance of diverse paralogues and protein isoforms that share great identity but have different functions, probably as a response to the evolutionary pressure exerted by their lifestyle and environment (Mugue & Ozernyuk 2006; Ikeda et al. 2007; Lee et al. 2012). Notably, two isoforms of *mlc2* were also identified in medaka and they are mapped to chromosomes 19 and 8, respectively (Figures 2 and 3). This localization provides further support for the model of teleost genome evolution proposed by Kasahara et al. (2007), that proto-chromosomes *d* and *e* were duplicated and rearranged during the teleost-specific whole genome duplication and they originated chromosomes 15, 19, 1 and 8 in medaka (Kasahara et al. 2007). Chromosome 8, where *mlc2b* has been located, is considered to have exclusively derived from proto-chromosome *e* (Kasahara et al. 2007). In addition, the localization of groups A and D of the myosin heavy chain on proto-chromosome *e* (Ikeda et al. 2007), suggests a common genome location may have generated the ancestral myosin genes. *Mlc2a* is located on chromosome 19, a fusion product of proto-chromosomes *d* and *e*. Arrangement of *mlc2a* and *mlc2b* on chromosomes 12 and 3, respectively, in the zebrafish genome is consistent with the picture in medaka, since both chromosomes are also considered the derivatives of proto-chromosomes *d* and *e* (Kasahara et al. 2007). *In silico*



identification of homologues of *mlc2* isoforms has shown that both *mlc2a* and *mlc2b* isoforms are located on different chromosomes in fish species. Localization in different chromosomes reinforces the hypothesis of divergent evolutionary trajectories, also confirmed by the phylogenetic tree. The only exception is tetraodon and zebrafish *mlc2b* that are both located on the same chromosome (chromosome 3).

Phylogenetic analyses of the potential homologous *mlc2a* and *mlc2b* isoforms indicated cross-species genes conservation and each *mlc2* isoform formed a separate cluster. Within each cluster teleost species phylogenetic relationships are conserved. Gilthead sea bream is evolutionary closest to the European sea bass –both belonging to the order Perciformes- while zebrafish (Cypriniformes) and Atlantic cod (Gadiformes) are the most derived species. Distances between Nile tilapia (Perciformes), orange-spotted grouper (Percimorfes), three-spined stickleback (Gasterosteiformes), Atlantic halibut (Pleuronectiformes), medaka (Beloniformes), tetraodon (Tetraodonitiformes) are intermediate (Figure 4). The phylogenetic relationships for both *mlc2* isoforms are in agreement with proposed models for teleost evolution (Steinke et al. 2006; Sarropoulou et al. 2007, 2008; Near et al. 2012). *Mlc2b* appears to be evolutionary conserved among species of the order Perciformes that cluster together in one group. Considering the prevailing *mlc2b* expression post-metamorphosis in gilthead sea bream, it is probable this isoform has a major role building up the muscle in the juvenile period in teleost species.

The minimal degree of conservation observed between the 3' UTR sequences of *mlc2a* and *mlc2b* (Sarropoulou et al 2006) point to the likely existence of different regulatory mechanisms for aspects governed by the 3' UTRs. In addition, the isolation of three alternative transcripts for *mlc2a* reinforces the idea that different regulatory mechanisms have evolved for the two isoforms. A number of genes have been identified with alternative 3' UTR regions, and include some of the myosin genes (Rotter et al. 1991; Miyamoto et al. 1996; Hirayama et al. 1998; Qu et al. 2002; Tranter et al. 2011). For example, human embryonic MLC1 makes use of two alternative 3' UTRs, produced by alternative splicing. In combination with two different promoters, four transcripts are produced that exhibit tissue-specific expression in fetal and adult stages (Rotter et al. 1991). Two mRNAs of the myosin regulatory light chain in the fast skeletal muscle of carp (*Cyprinus carpio* L.; Hirayama et al. 1998) encode for proteins with identical amino acid sequences, yet they differ in the length of their 3' UTRs due to alternative polyadenylation site selection. Interestingly, only the long transcript of *mlc* in carp was regulated by temperature (Hirayama et al. 1998).

Cumulative evidence has connected 3' UTR function with a series of post-transcriptional functions from mRNA localization in subcellular regions to cytoplasmic polyadenylation and deadenylation and regulation of translation efficiency through the recruitment of 4E binding proteins, regulation of ribosomal subunit binding and post-initiation repressing by microRNAs (de Moor et al. 2005; Andreassi and Riccio 2009). The existence of alternative 3' UTRs for the same coding sequences is an elaborate regulatory tool of expression that allows the spatial resolution of expression at crucial moments of cell differentiation or in response to extracellular stimuli. Both alternative splicing and alternative poly(A) site selection appear to contribute significantly to the generation of alternative 3' UTRs. An in-depth analysis of the transcriptomes of 15 human tissues and cell lines revealed that the highest degree of isoform variability generated from alternative splicing is in the alternative use of different 3' UTRs and polyadenylation sites, resulting in the generation of mRNA transcripts containing either a short or long 3' UTR (Wang et al. 2008). Alternative polyadenylation is a wide-spread phenomenon in the mammalian genome (Tian et al. 2005). Alternative poly(A) sites are found in the most 3' UTR exons, alternative use of which produces mRNA isoforms with a 3' UTR of variable length (Lutz 2008). The isolation of alternative 3' UTRs for *mlc2a* suggests a high demand for fine regulation of the expression of this particular gene. This is in agreement with the dominant role of *mlc2a* in early embryonic stages, when the speed of events requires tight regulation of gene expression both in space and time. All transcripts of *mlc2a* were detectable at each time point in primary muscle cell cultures and larvae (Figures 5 and 6). The short alternative transcript was the most abundant followed by the long and medium alternative transcripts. Interestingly, this picture was consistent between larvae and cultured myocytes and provides evidence that primary myocyte cultures undergo the same differentiation program with their counterparts *in vivo*. The big difference in the relative presence of the three alternative transcripts might be the reflection of different half-life -storage and degradation- within the cell or their differential function in subcellular localization and translational efficacy. More detailed studies are required to shed light on the functionality of the three different 3' UTRs.

Functional diversification of paralogues is frequently observed (Bower & Johnston 2010; Opazo et al. 2012) and they may acquire distinct functions (neofunctionalization) or share the function of the ancestral gene (subfunctionalization). It has been proposed that subfunctionalization can occur when the *cis*-acting regulatory regions of the duplicated

genes undergo mutations, manifested through altered expression patterns. According to this idea, the function of paralogues recapitulates that of the ancestral gene (Force et al. 1999). The spatial redundancy, yet distinct expression patterns of the three paralogues of *myoD1* in Atlantic salmon (*Salmo salar* L.) during somitogenesis and in proliferating-differentiating myogenic cells offer support for this idea (Macqueen et al. 2007; Bower & Johnston 2010). MLC2 isoforms share the same function as constituents of the myosin molecule and they are both expressed in differentiating myocytes in culture (Figure 6). However, *mlc2* isoforms are expressed at different phases of myogenesis, both *in vitro* in primary cultures of myogenic cells and also *in vivo* in developing larvae. In the present study, *mlc2a* dominated the early stages of myogenesis whereas *mlc2b* was abundant later after the differentiation stage. Notably, the transition from larva to adult was marked by the switch from MLC2A to MLC2B isoform and coincided with the transition from hyperplastic to hypertrophic events that shape muscle cellularity (Rowlerson et al. 1995). Isoforms A and B of the *mlc2* gene have been also isolated in Atlantic halibut, where isoform A represents the embryonic isoform and isoform B represents the larval/juvenile isoform (Galloway et al. 2006). Both *mlc2* isoforms were identified in the gilthead sea bream fast skeletal muscle transcriptome using next generation sequencing (Garcia de la serrana et al. 2012). *mlc2b* was highly expressed in juveniles confirming that *mlc2b* is the predominant juvenile isoform in gilthead sea bream development. Larval isoforms are replaced by the adult ones after the metamorphic climax in Atlantic herring (*Clupea harengus*, Crockford & Johnston, 1993), Japanese flounder (*Paralichthys olivaceus*, Yamano et al. 1994), in African catfish (*Heterobranchus longifilis*, Huriaux et al. 1999) and in turbot (*Scophthalmus maximus*, Focant et al. 2003). In plaice (*Pleuronectes platessa*), two larval and two post-metamorphic isoforms have been reported (Brooks & Johnston 1993). Larval and adult isoforms likely possess specialized physicochemical properties that would impact muscle contraction characteristics, like force generation or shortening velocity, as has been demonstrated for the essential light chains (Reiser & Bicer 2006).

In primary myocyte cultures, cumulative *mlc2a* expression was correlated with myogenin expression in full agreement with the presence of six E-boxes, binding sites to bHLH myogenic factors in its promoter (Funkenstein et al. 2007). In primary myocyte cultures myogenin and *mlc2a* exhibit overlapping expression, while myogenin peaked with *mlc2a* at metamorphosis in developing larvae (Figures 5 and 6). However, no induction of myogenin preceded the induction of *mlc2a* expression in juveniles two days post-

administration of GH (Figure 7). It is highly possible that other regulatory mechanisms are established post-metamorphosis to drive growth over differentiation. In primary myocyte cultures, *myoD2*, although did not reach high levels of expression, also displayed a significant correlation with myogenin ( $R=0.432$ ,  $P<0.05$ ) and *mlc2a* ( $R=0.691$ ,  $P<0.01$ ), respectively. The MRFs share partial redundancy and *in vitro*, each one can convert several cell lines to muscle cells (Weintraub et al. 1989). However, each gene has evolved a specialist function in initiating or maintaining myogenesis. MyoD is a transcription factor with binding sites in the regulatory regions of many genes expressed throughout the myogenic program (Blais et al. 2005; Tapscott 2005). MyoD is known to promote cell cycle withdrawal and induction of myoblast differentiation (Ishibashi et al. 2005). Subsequently, it is myogenin that mediates differentiation and is involved in myotube formation and synthesis of proteins of the contractile apparatus (Sanchez & Robins 1994; Venuti et al. 1995; Dedieu et al. 2002). The expression pattern of the two MRFs during myogenesis *in vivo* and *in vitro* in gilthead sea bream is in agreement with their role as it has been in other organisms and cell lines. MyoD2 was continuously expressed to introduce more cells into the myogenic fate, while myogenin expression was closely followed by the expression pattern of contractile proteins, i.e. MLC2. In juveniles administered GH, that myogenesis runs in a different mode with new fibers formed in between existed ones (mosaic hyperplasia) this link was not apparent, suggesting some shift in regulation in the later stages. The links between MLC2 isoforms and myogenic factors are further explored in Chapter 4.

Growth hormone is the systemic regulator of growth processes in fish. It exerts its action on different tissues via the IGFs that are locally produced and act in a paracrine-autocrine function, whereas there is mounting evidence that they might also act independently (Bjornsson et al. 2002). Given that white musculature amounts approximately 70 % of the teleost body, the expression, synthesis and deposition of sarcomeric proteins represents the ultimate process of growth. Administration of GH led to a significant non dose-dependent induction of both *mlc2* isoform expression (Figure 7) that adds to the systemic supervision of growth by GH, although the steps of this supervision are not known and they do not involve myogenin. However, the timing of the induction differed between the two *mlc2a* isoforms; *mlc2a* exhibited an earlier response compared with *mlc2b* that was elevated only 7 days after GH administration. The different induction of *mlc2a* and *mlc2b* by GH provides further support to our hypothesis that *mlc2* isoforms are paralogues

that have undergone subfunctionalization and that this has been achieved by the establishment of different regulatory mechanisms.

In conclusion, *in silico* identification of homologues of the two *mlc2* isoforms in model fish species indicated that they are localized to different chromosomes. The present data support previous observations that MLC2A marks the newly-formed muscle fibers since its expression starts at the beginning of muscle differentiation *in vivo* and *in vitro*. As part of the contractile apparatus, *mlc2a* transcripts presumably increase to provide sufficient amounts of protein to support the increasing volume and function of the growing muscle cell. The existence of three alternative transcripts for *mlc2a* indicates the existence of an elaborate post-transcriptional regulation governed by elements residing in the 3' UTR in the gilthead sea bream. The correlation between *mlc2a* and myogenin expression is in agreement with the presence of six E-boxes for myogenic factor binding in the promoter region previously isolated (Funkenstein et al. 2007). MLC2A is replaced by MLC2B post-metamorphosis and both isoforms are targets of GH action, yet in a differential manner. The phylogenetic analysis revealed clustering of *mlc2a* and *mlc2b* in different groups an additional indication of the divergence of the two paralogues.

*Chapter Σφάλμα! Χρησιμοποιήστε την καρτέλα "Κεντρική σελίδα", για να εφαρμόσετε το Heading 1 στο κείμενο που θέλετε να εμφανίζεται εδώ.*

---

## ***Chapter 3***

*Chapter Σφάλμα! Χρησιμοποιήστε την καρτέλα "Κεντρική σελίδα", για να εφαρμόσετε το Heading 1 στο κείμενο που θέλετε να εμφανίζεται εδώ.*

---

## **Chapter 3**

### ***The 3' untranslated regions of *mlc2* isoform A: structure and function***

#### **3.1 Introduction**

Gene regulation occurs both at the transcriptional level, tuning quantitatively and qualitatively gene transcription, and post-transcriptionally modulating the fate of mRNA molecules following their synthesis (Mignone et al. 2002). In eukaryotic cells transcription is orchestrated by several transcription factors, RNA polymerase and many *cis*-acting sequences such as promoters, enhancers, silencers and locus-control elements. The functional mRNA molecule is composed of three parts; the 5' untranslated region, the protein coding region and the 3' untranslated region (Berg et al. 2002; Mignone et al. 2002; Moor et al. 2005). Dynamics of gene expression is further regulated during mRNA maturation and 3' UTR processing. The modulation of RNA transcript abundance, stability, degradation, export to the cytoplasm, sub-cellular localization and translational efficiency is under the control of the alternative polyadenylation mechanism and sequences lying in the 3' UTR (Colgan & Manley 1997; Mueller et al. 2013).

In alternative polyadenylation, the cleavage occurs 10-30 nts downstream of one of the multiple polyadenylation signal (Di Giammartino et al. 2011). Multiple polyadenylation signals commonly occur in the genes of many species ranging from 10 % in yeast (Nagalakshmi et al. 2008) to 50 % in humans (Tian et al. 2005). The selection of a polyadenylation signal depends upon the interplay between several regulatory factors, the underlying 3' UTR sequence and the secondary structure that is formed (Nunes et al. 2010). Secondary RNA structure and the formation of stems, loops or bulges may also exert a catalytic role in mRNA processing during transcription and translation procedures as well as its degradation (Alonso 2012; Mueller et al. 2013). Translational efficiency is further modulated by additional sequences in the 3' uncoding region as well as by the localization of mRNA molecules in discrete intracellular compartments (Stebbins-Boaz & Richter 1994; De Moor & Richter 1997), which also depends on cellular "addresses" residing in *cis*-acting sequences in the 3' untranslated region (Ainger et al. 1997). Finally, mRNA transcripts are subject to molecular mechanisms governing their decay in canonical or noncanonical pathways (Garnaue et al. 2007). The "degradation code" involves the sequestering of RNA-



binding proteins or miRNA-containing proteins in the *cis*-acting elements of 3' UTRs. The extreme conservation observed in vertebrates 3' UTRs, is a strong advocate of their significance in the post-transcriptional regulation (Siepel et al. 2005).

The formation of multicellular organisms from fertilization onwards requires the fine regulation of gene expression in time and space for the asymmetric distribution of cell fate determinants. Translation in discrete intracellular compartments in specific time-points underlies cell polarization and embryonic patterning (López de Heredia & Jansen 2003; Martin & Ephrussi 2009; Alonso 2012). *cis*-acting regulatory elements in 3' UTRs are highly involved in the switch observed in developmental programs and in myogenesis 3' UTR length was predicted to decrease in adult stem cell commitment to myogenic lineage followed by an increase during the differentiation phase (Mueller et al. 2013). Sequences in the 3' UTRs are also targeted by small-noncoding RNAs, miRNAs, which shape gene expression by destabilizing it or inhibiting transcript translation (Filipowicz et al. 2008; Fabian et al. 2010). Myogenesis is largely tuned by miRNA expression, which coordinate the myogenic process, from proliferation to terminal differentiation of myoblasts. Their expression pattern and their key regulator role in the course of myogenesis are uniform in many species, such as common carp, zebrafish, mouse and pig (Chen et al. 2006, 2010; Huang et al. 2008; Mishima et al. 2009) reaching highest levels in the mature myotubes. Many muscle-specific miRNAs shape gene expression by binding to 3' UTRs of muscle genes such as myogenin and *myoD* (Rao et al. 2006).

In gilthead sea bream regulatory myosin light chain 2 isoform A mRNA undergoes alternative polyadenylation site selection to produce three different transcripts that encode for the same peptide but differ in the length of their 3' UTRs (284bp, short; 788bp, medium; 876bp, long; Sarropoulou et al. 2006). During gilthead sea bream development, *mhc2a* alternative transcripts were present at the onset of somitogenesis and remained high in the early larval stages but were down-regulated around metamorphosis (Chapter 2). In both developing larvae and cultured myocytes, short alternative transcript was the most abundantly expressed followed by the long and medium alternative transcripts. Differential expression pattern of the three *mhc2a* alternative transcripts may be shaped by their post-transcriptional processing and degradation rates, which are also expected to influence their translatability.

The present study focuses on *in silico* a) identification of *cis*-acting sequences in 3' UTR of the MLC2A alternative transcripts, and b) prediction of their secondary structures,

*Chapter Σφάλμα! Χρησιμοποιήστε την καρτέλα "Κεντρική σελίδα", για να εφαρμόσετε το Heading 1 στο κείμενο που θέλετε να εμφανίζεται εδώ.*

---

while c) exploring the functionality of 3' UTRs in interaction with the cell protein machinery *in vitro* with using luciferase reporter constructs. The possible links between secondary structure, regulatory sequences and transcriptional-translational efficiency are discussed.

## 3.2 Materials & Methods

### 3.2.1 Bioinformatic analysis of *mlc2a* 3' UTRs

3' untranslated regions of the three *mlc2a* transcripts (*mlc2a*-short, *mlc2a*-medium, *mlc2a*-long, Sarropoulou et al. 2006) were searched *in silico* for polyadenylation signals in their multiple forms (ATTAAA, AGTAAA, TATAAA, CATAAA, GATAAA, AATATA, AATACA, AATAGA, AATGAA, ACTAAA, AACAAA, TTTAAA; Beaudoin et al. 2000). UTRscan was performed to identify motifs in the 3' UTR whose functional role has been experimentally tested and well documented. U-rich regions (Alonso 2012) were searched along the 3' UTRs (Fasta file 2).

*cis*-acting elements located in the 3' UTRs that modify gene expression were searched in the literature. Many sequences regulating alternative polyadenylation and deadenylation, sub-cellular localization, translational repression, muscle-specific miRNAs in many species during their developmental course were searched (Table 1) along *mlc2a* 3' UTRs (Fasta file 1):

- CPE (cytoplasmic polyadenylation element) in *Xenopus* (de Moor & Richter 1999)
- ARE (AU-rich elements) responsible for cytoplasmic polyadenylation (Mignone et al. 2002)
- RTS (RNA transport signal) of the human, rat, mouse and bovine amyloid precursor protein (Ainger et al. 1997)
- EDEN (deadenylation element) in *Xenopus* (Paillard et al. 1998)
- M1-motif of mRNAs enriched at the mitochondrial surface of yeasts and humans (Shalgi et al. 2005)
- sequence responsible for translation inhibition of the TCE (translational control element) in *Drosophila* (Dahanukar et al. 1996)
- nos-response element (NRE) for nos-dependent repression of *bcd* and *hb* mRNAs in *Drosophila* (Wharton et al. 1991; Wreden et al. 1997)
- element responsible for translational repression (TRE) of *osk* gene in *Drosophila* (Kim-Ha et al. 1995)

- region responsible for inhibition of translation (IRE) of 15-lipoxygenase in rabbit (Ostareck-Ledeler et al. 1994)
- protection and degradation elements (PDE) in *Hsp83* transcripts of *Drosophila* (Bashirullah et al. 1999)
- *lin-4* developmental stage-specific miRNA (Wightman et al. 1993)
- *miR-1*, *miR-133*, *miR-206*, *miR-21*, *miR-26a*, *miR-27a*, *miR-214*, *miR-222* muscle-specific miRNAs (Yan et al. 2012 and references therein)

**Table 1:** Sequences and origin of the *cis*-acting elements located in the 3' UTRs that modify gene expression in various species. U<sub>x</sub>: U-rich sequence; CPE: cytoplasmic polyadenylation element; ARE: AU-rich element; RTS: RNA transport signal; EDEN: deadenylation element; TCE: translational control element; NRE: nos-response element; TRE: translational repression element; IRE: region responsible for inhibition of translation, PDE: protection and degradation elements; miRX: miRNA X.

<b>Cis-acting element</b>	<b>Sequence</b>	<b>Species/Origin</b>	<b>Reference</b>
<b>U-rich</b>	<b>UUUU</b>	<i>Drosophila</i>	Alonso et al. 2012
<b>CPE</b>	<b>UUUUA<sub>1-2</sub>U</b>	<i>Xenopus</i>	de Moor & Richter 1999
<b>ARE</b>	<b>AUUUA</b>	<i>Mus musculus</i>	Mignone et al. 2002
<b>RTS</b>	<b>TGCCAAGGAGCCAGAGAGCATG</b>	<i>Homo sapiens</i> , <i>Rattus norvegicus</i> , <i>Mus musculus</i> , <i>Bos taurus</i>	Ainger et al. 1997
<b>EDEN</b>	<b>TATATGTATGTGTTGTTTTATGT GTGTGTGTGTGCT</b>	<i>Xenopus</i>	Paillard et al. 1998
<b>M1-motif</b>	<b>TGTAHATA</b>	<i>Saccharomyces cerevisiae</i> , <i>Homo sapiens</i>	Shalgi et al. 2005

Chapter Σφάλμα! Χρησιμοποιήστε την καρτέλα "Κεντρική σελίδα", για να εφαρμόσετε το Heading 1 στο κείμενο που θέλετε να εμφανίζεται εδώ.

<b>TCE</b>	<b>CUGGC</b>	<i>Drosophila</i>	Dahanukar et al. 1996
<b>NRE</b>	<b>GUUGU-----AUUGUA</b>	<i>Drosophila</i>	Wharton et al. 1991; Wreden et al. 1997
<b>TRE</b>	<b>U(G/A)U(A/G)U(G/A)U</b>	<i>Drosophila</i>	Kim-Ha et al. 1995
<b>IRE</b>	<b>CCCCA/GCCCTCTTCCCCAAG</b>	<i>Oryctolagus cuniculus</i> )	Ostareck-Ledeler et al. 1994
<b>PDE</b>	<b>Degradation element: CCAAGTA.....TAAAGAATC Protection element: GAGTATA.....TAAAAATCT</b>	<i>Drosophila</i>	Bashirullah et al. 1999
<i>lin-4</i>	<b>CUCAGGGAA</b>	<i>Caenorhabditis elegans</i>	Wightman et al. 1993
<i>miR-1</i>	<b>UGGAAUGUAAAGAAGUAUGUAU</b>	<i>Danio rerio, Mus musculus, Homo sapiens</i>	Yan et al. 2012
<i>miR-133</i>	<b>UUGGUCCCCUUAACCAGCUGU</b>	<i>Danio rerio, Mus musculus</i>	Yan et al. 2012
<i>miR-206</i>	<b>UGGAAUGUAAGGAAGUGUGUGG</b>	<i>Mus musculus, Homo sapiens</i>	Yan et al. 2012
<i>miR-21</i>	<b>UAGCUUAUCAGACUGGUGUUGGC</b>	<i>Rattus norvegicus</i>	Yan et al. 2012
<i>miR-26a</i>	<b>UUCAAGUAAUCCAGGAUAGGCU</b>	<i>Mus musculus</i>	Yan et al. 2012
<i>miR-27a</i>	<b>UUCACAGUGGCUAAGUUCCGC</b>	<i>Mus musculus</i>	Yan et al. 2012
<i>miR-214</i>	<b>UACAGCAGGCACAGACAGG</b>	<i>Danio rerio, Mus</i>	Yan et al.

		<i>musculus</i>	2012
<b>miR-222</b>	<b>AGCUACAUCUGGCUACUGGG</b>	<i>Mus musculus</i>	Yan et al. 2012

### 3.2.1.1 *mlc2a* secondary structures prediction

mRNA secondary structure was predicted using the “mfold” software (Zuker 2003). The core algorithm of ‘mfold’ software for RNA folding predicts a minimum free energy, dG. The software predicts a number of optimal and suboptimal foldings that obey the thermodynamic laws in order of increasing free energy. The mRNA structure that is finally selected is the folding with the minimum free energy (optimal). The sequences coding for the three *mlc2a* transcripts were used. The sequence of the transcripts contains a part of the 5’ UTR starting from the polyadenylation signal (TATAA) (Funkenstein et al. 2007), the coding sequence of *mlc2a* (AF150904) and the 3’ UTR of each alternative transcript (Sarropoulou et al. 2006) (Fasta File 2). Characteristic sequences of transcription and translation processes were marked in the mRNA secondary structures. Namely these are TATAA box and CAAT box, poly(A) signal (AAUAAA) and poly(A) tail for transcription (black color) and AUG and UAA initiation and stop codons respectively for translation (pink color).

### 3.2.1.2 *mlc2a* 3’ UTRs regulation of expression

To further investigate the preferential choice of *mlc2a* 3’ UTR structures by the gene regulatory program each 3’ UTR was fused with firefly luciferase gene in reporter vectors. The resulting constructs were introduced in Chinese Hamster Ovary (CHO) mammalian cells in order to eliminate interaction with the plethora of myogenic regulatory factors present in myogenic cell lines. Luciferase reporter assays were performed to determine the transcriptional efficiency of each 3’ UTR as indicated by fluctuation in luciferase expression levels.

### 3.2.2 Construction of the recombinant plasmids

The 3' UTR region of the *mlc2a*-short and *mlc2a*-medium transcripts was amplified from gilthead sea bream muscle cDNA with the 3UTRF and 3UTRs, 3UTRm or 3UTRl primers for *mlc2a*-short, *mlc2a*-medium and *mlc2a*-long respectively (Table 2) using the iProof DNA polymerase enzyme (BioRad) according to the manufacturer's instructions. Primers were constructed to include the specific restriction digestion sites for the XbaI and BamHI to promote directional cloning in the pGL3-Promoter expression vector (Promega) downstream of luciferase coding sequence to substitute the SV40 late poly(A) signal (Figure 1). PCR amplifications were carried out for a final volume of 40 µl for 35 cycles. The obtained PCR product (268 bp, 795 bp and 880 bp for short, medium and long transcripts respectively) was extracted from agarose gel and purified using the illustra GFX PCR DNA and Gel Band Purification Kit (GE Healthcare) and quantified in the NanoDrop 1000 (Thermo Scientific, *mlc2a*-short: 75.1 ng/µl; *mlc2a*-medium: 62.7 ng/µl, *mlc2a*-long: 70.7 ng/µl). 1.4 µg of the PCR product and 1 µg of the pGL3 plasmid were digested with the XbaI and BamHI enzymes and the digested product was purified using the phenol-chloroform method according to Maniatis et al. (1982). 0.2 µg of the digested PCR product was directionally cloned in the digested pGL3-Promoter vector in ligation reactions final volume of 10 µl. Reaction was carried out for 1 hr at 22 °C. Competent *E. coli* DH5alpha (Invitrogen) were transformed and positive bacteria clones were isolated and grown in LB supplemented with 50 µg/µl ampicillin for 16 hrs and the recombinant plasmid DNA was isolated with the GeneJet Plasmid Miniprep kit (Fermentas) according to the instructions. Recombinant plasmids were sent for sequencing to confirm identity before proceeding with cell transfections.

**Table 2:** Primer sequences used in this study. 3'UTRF is common for all three transcripts; *mlc2a*-short, *mlc2a*-medium, *mlc2a*-long, FW (forward primer), RV (reverse primer). **GCGTCTAGA**: specific restriction digestion site for the XbaI, **GCGGGATCC**: specific restriction digestion site for the BamHI.

Transcript	Primer name		Primer sequence	Size (bp)
Common for all transcripts	FW	3UTRF	GCGTCTAGAATCCCCCTCTCTTT	
<i>mlc2a</i> -short	RV	3UTRs	GCGGGATCCCAGTGCCACAAGAT	268
<i>mlc2a</i> -medium		3UTRm	GCGGGATCCGACATTTCACTTT	795
<i>mlc2a</i> -long		3UTRI	GCGGGATCCACGAAGATAGTGG	880

### 3.2.2.1 Cell culture and cell transfections

Chinese Hamster Ovary (CHO) mammalian cells were cultured and maintained in Dulbecco's Modified Eagle's Medium (DMEM, Sigma) supplemented with 10 % fetal bovine serum (Sigma), 1 % penicillin/streptomycin (Sigma) and 1 % Amphotericin B (Sigma) at 37 °C in a humidified incubator containing 5 % CO<sub>2</sub>. On day prior to cell transfections, 4 x 10<sup>5</sup> cells ml<sup>-1</sup> (reach approximately 50-70 % confluence) were seeded on 6-well plate (Sarsted) and cell transfections were performed using the Fugene 6 transfection reagent (Promega). CHO cells were transfected with containing the short or medium 3' UTRs or with both constructs simultaneously. Cell transfections were performed with 1 µg of each recombinant vector constructs and 6 µl of Fugene 6 (1:6 ratio) on a final volume of 100 µl complemented with DMEM. Transfection complex was prepared according to the Fugene 6 instructions and was incubated for 40 min at room temperature prior being added to the cells with 500 µl of DMEM. A vector containing the EGFP protein and 1 µg of empty pGL3 vector were used as transfection positive control and the luciferase assay positive control, respectively. Cells were maintained in culture prior assayed.



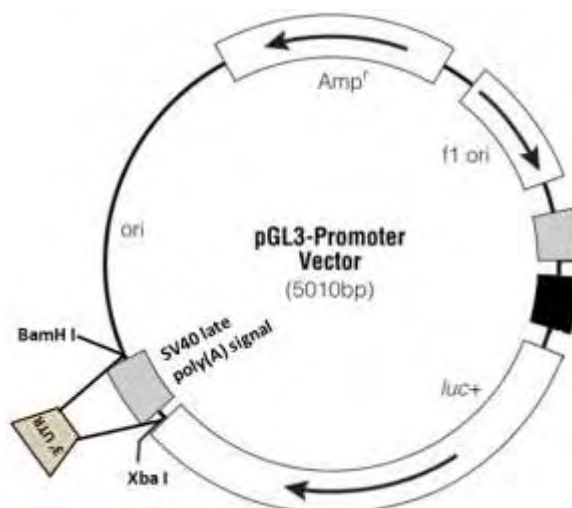

**Figure 1** Schematic representation of the pGL3-Promoter vector with the 3' UTR constructs cloned between XbaI and BamHI restriction sites to substitute the SV40 late poly(A) signal.

### 3.2.2.2 Luciferase assay

Three days after transfections, CHO cells were washed with 1x PBS, counted and harvested in phosphate-buffered saline and plated at a density of  $2.5 \times 10^4$  cells/well in a 96-well plate (Sarsted) and lysed using alternate cycles of  $-80\text{ }^\circ\text{C}$  for 10 min and  $42\text{ }^\circ\text{C}$  for 10 min. Cells were centrifuged and 100  $\mu\text{l}$  of the lysate were collected and transferred to 96-well flat-bottom white plates (Greiner) to measure the luciferase activity with the Bright-Glo Reagent (Promega). Cell background was measured using the Synergy H4 Hybrid Multi-Mode Microplate Reader (Biotek) according to the Gen5™ & Gen5 Secure User's Guide Microplate Data Collection & Analysis Software. 100  $\mu\text{l}$  of Bright-Glo Reagent (Promega) was added to the cell lysates and incubated for 2 min at room temperature in the dark and luciferase activity was measured using the same software described before. For each construction reactions were performed in triplicate and a total of 3 different assays performed using the GraphPad Prism 6 (GraphPad Software).

Experiment 3.2.2 (*Construction of recombinant plasmids, Cell culture and cell transfection, Luciferase assay*) was conducted in Comparative Molecular Endocrinology Group in the Center of Marine Sciences in Faro, Portugal under the supervision of Prof. Deborah M. Power and under the guidance of Dr. Joao Cardoso.

### 3.3 Results

#### 3.3.1 The 3' untranslated regions of *mlc2a* alternative transcripts

The three alternative transcripts of *mlc2a* have 3' UTRs of different length; 284 bp, 795 bp and 876 bp, which correspond to *mlc2a*-short, -medium and -long transcripts respectively (Sarropoulou et al. 2006, Figure 2). In total, 1, 2 and 4 polyadenylation signals (AATAAA; Figure 2) were detected in the short, medium and long transcript, respectively. Two of them were common for all three transcripts (604-609 nts and 854-859 nts), one of them was common between *mlc2a*-medium and *mlc2a*-long (1384-1389 nts) and two of them were unique for the *mlc2a*-long transcript (1468-1473 nts and 1483-1488 nts). Another form of polyadenylation signal (AATAGA) was also detected in *mlc2a*-medium and *mlc2a*-long transcripts (1226-1232 nts).

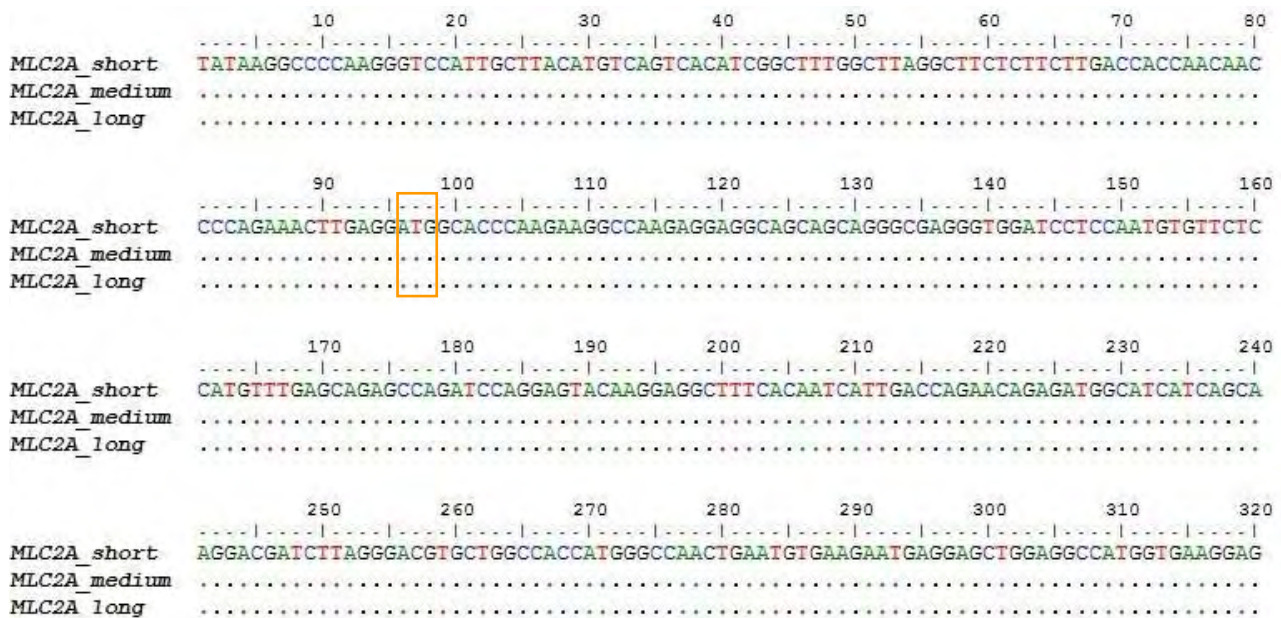

Chapter Σφάλμα! Χρησιμοποιήστε την καρτέλα "Κεντρική σελίδα", για να εφαρμόσετε το Heading 1 στο κείμενο που θέλετε να εμφανίζεται εδώ.

```

          330      340      350      360      370      380      390      400
MLC2A_short  -----|-----|-----|-----|-----|-----|-----|-----|
MLC2A_medium -----|-----|-----|-----|-----|-----|-----|-----|
MLC2A_long   .....|.....|.....|.....|.....|.....|.....|.....|
          410      420      430      440      450      460      470      480
MLC2A_short  -----|-----|-----|-----|-----|-----|-----|-----|
MLC2A_medium -----|-----|-----|-----|-----|-----|-----|-----|
MLC2A_long   .....|.....|.....|.....|.....|.....|.....|.....|
          490      500      510      520      530      540      550      560
MLC2A_short  -----|-----|-----|-----|-----|-----|-----|-----|
MLC2A_medium -----|-----|-----|-----|-----|-----|-----|-----|
MLC2A_long   .....|.....|.....|.....|.....|.....|.....|.....|
          570      580      590      600      610      620      630      640
MLC2A_short  -----|-----|-----|-----|-----|-----|-----|-----|
MLC2A_medium -----|-----|-----|-----|-----|-----|-----|-----|
MLC2A_long   .....|.....|.....|.....|.....|.....|.....|.....|
          650      660      670      680      690      700      710      720
MLC2A_short  -----|-----|-----|-----|-----|-----|-----|-----|
MLC2A_medium -----|-----|-----|-----|-----|-----|-----|-----|
MLC2A_long   .....|.....|.....|.....|.....|.....|.....|.....|
          730      740      750      760      770      780      790      800
MLC2A_short  -----|-----|-----|-----|-----|-----|-----|-----|
MLC2A_medium -----|-----|-----|-----|-----|-----|-----|-----|
MLC2A_long   .....|.....|.....|.....|.....|.....|.....|.....|
          810      820      830      840      850      860      870      880
MLC2A_short  -----|-----|-----|-----|-----|-----|-----|-----|
MLC2A_medium -----|-----|-----|-----|-----|-----|-----|-----|
MLC2A_long   .....|.....|.....|.....|.....|.....|.....|.....|
          890      900      910      920      930      940      950      960
MLC2A_short  -----|-----|-----|-----|-----|-----|-----|-----|
MLC2A_medium -----|-----|-----|-----|-----|-----|-----|-----|
MLC2A_long   .....|.....|.....|.....|.....|.....|.....|.....|
          970      980      990      1000     1010     1020     1030     1040
MLC2A_short  -----|-----|-----|-----|-----|-----|-----|-----|
MLC2A_medium -----|-----|-----|-----|-----|-----|-----|-----|
MLC2A_long   .....|.....|.....|.....|.....|.....|.....|.....|

```

Chapter Σφάλμα! Χρησιμοποιήστε την καρτέλα "Κεντρική σελίδα", για να εφαρμόσετε το Heading 1 στο κείμενο που θέλετε να εμφανίζεται εδώ.

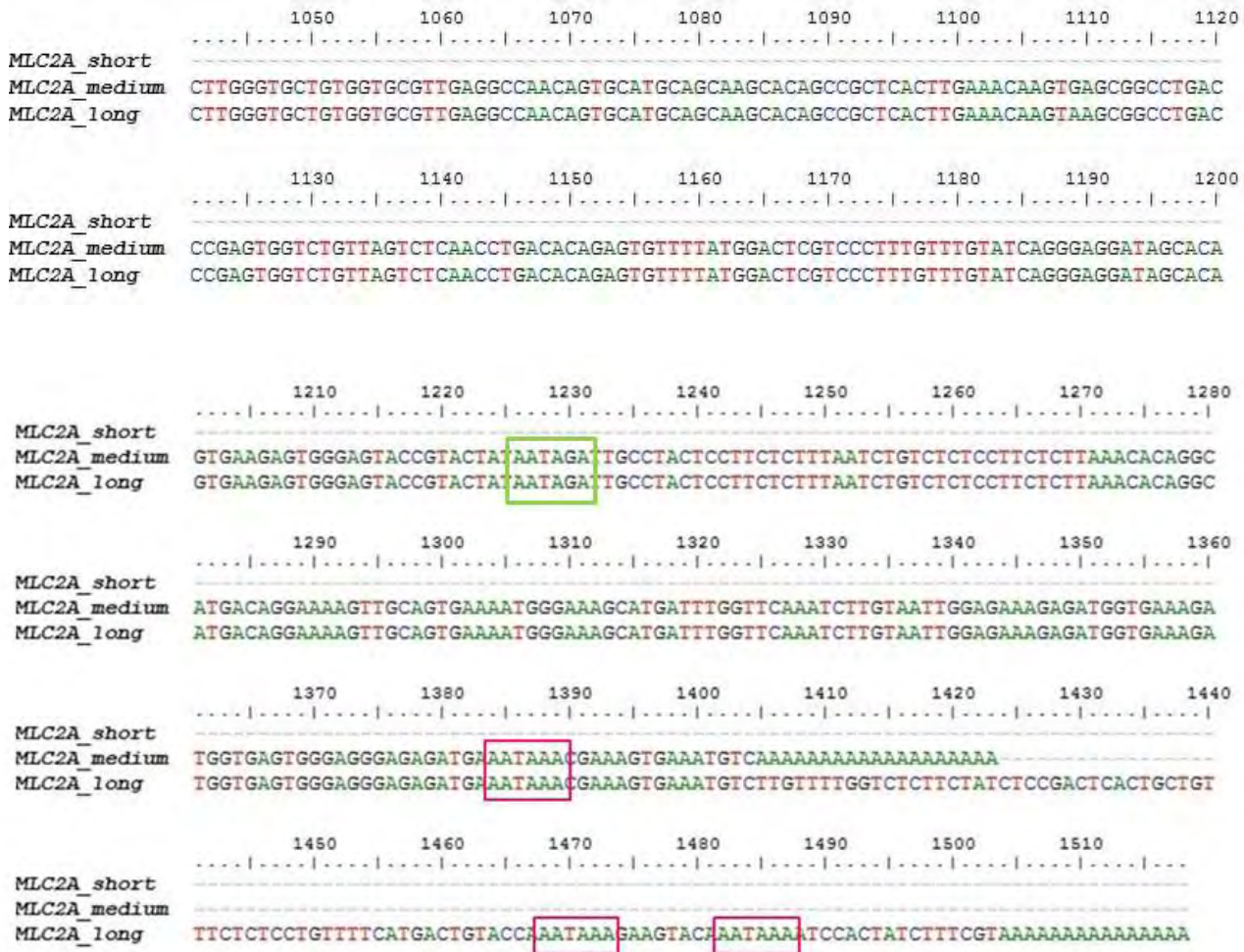

**Figure 2:** Gilthead sea bream *mlc2a* gene. The nucleotide sequence is composed of part of 5' UTR as deposited by Funkenstein et al. (2007) (GenBank accession no. EF187431) starting from the TATA box, the coding sequence of *mlc2a* gene starts at 96 nts (Moutou et al. 2001, GenBank accession no. AF150904) and 3' UTR sequence starts at 609 nts (Sarropoulou et al. 2006). Start (96-99 nts) and terminal codons (606-609 nts) are in orange and black boxes respectively. Dots represent identical nucleotides. Dashes indicate missing sequence. poly(A) signals AATAAA and AATAGA are boxed in magenta and green color respectively. Adapted from Sarropoulou et al. (2006).

### 3.3.2 Bioinformatic analysis of *mlc2a* 3' UTRs

U-rich sequences were identified in all three transcripts of *mlc2a*. TTTT sequence motif was found once in *mlc2a*-short (849-852 nts, Figure 3, Table 3), three times in *mlc2a*-medium (849-852 nts, 921-924 nts, 1157-1160 nts, Figure 4, Table 3) and five times in *mlc2a*-long (849-852 nts, 921-924 nts, 1157-1160 nts, 1408-1411 nts, 1451-1454 nts, Figure 5, Table 3).

Scanning of the 3' noncoding regions of *mlc2a* transcripts on the UTRsite indicated regulatory elements present in UTRs. One upstream orf (uORF) was revealed in *mlc2a*-short (688-777 nts, Fasta file 2, Figure 3, Table 3), four in *mlc2a*-medium (688-777 nts, 840-1136 nts, 1161-1337, nts, 1132-1137 nts, Fasta file 2, Figure 4, Table 3) and four in *mlc2a*-long (688-777 nts, 840-1136 nts, 1132-1137 nts, 1350-1472 nts, Fasta file 2, Figure 5, Table 3). In the long transcript a Mushasi binding element (MBE) was detected (1132-1137 nts, Fasta file 2, Figure 5, Table 3).

The sequence coding for the cytoplasmic polyadenylation element (CPE, TTTTAT) was identified in *mlc2a*-medium and *mlc2a*-long transcripts (1157-1162 nts, Fasta file 2, Figures 4 and 5 respectively, Table 3). M1 motif of the mRNAs localized in mitochondria (TGTAHATA, where H=C) was found in *mlc2a*-long (1587-1594 nts, Fasta file 2, Figure 5, Table 3). CTGGC motif part of the translational control element (TCE) responsible for inhibition of translation was identified in all *mlc2a* transcripts (740-744 nts for *mlc2a*-short, 740-744 nts & 1024-1029 nts for *mlc2a*-medium and *mlc2a*-long, Fasta file 2, Table 3). Half of the nos-responsive element (NRE, GTTGT of GTTGT-----ATTGTA) was identified in all *mlc2a* transcripts (809-814 nts, Fasta file 2, Table 3). Of the miRNAs only *lin-4* sequence (CTCAGGGA) was identified in all *mlc2a* alternative transcripts (782-789 nts, Figures 3, 4, 5, Table 3).

Many *cis*-acting elements were searched but not identified in 3' UTRs of the three *mlc2a* transcripts. These were the ARE (AU-rich elements) responsible for cytoplasmic polyadenylation, the RTS (RNA transport signal), the EDEN (deadenylation element), the element responsible for translational repression of *osk* gene, region responsible for inhibition of translation of 15-lipoxygenase and the position and degradation elements in *Hsp83* transcripts. None of the muscle-specific miRNAs *miR-1*, *miR-133*, *miR-206*, *miR-21*, *miR-26a*, *miR-27a*, *miR-214* and *miR-222* was found in *mlc2a* alternative transcripts (Table 3).

**Table 3:** Sequences and origin of the *cis*-acting elements identified in the 3' UTRs of *mlc2a*-short, -medium and -long transcripts. "+" indicates presence and "-" absence, respectively, of the *cis*-acting element respectively. CPE: cytoplasmic polyadenylation element; ARE: AU-rich element; uORF: upstream orf, MBE: Mushashi binding element, RTS: RNA transport signal; EDEN: deadenylation element; TCE: translational control element; NRE: nos-response element; TRE: translational repression element; IRE: region responsible for inhibition of translation, PDE: protection and degradation elements; miRX: miRNA X

<b><i>Cis</i>-acting element</b>	<b><i>mlc2a</i>-short</b>	<b><i>mlc2a</i>-medium</b>	<b><i>mlc2a</i>-long</b>
<b>U-rich</b>	+	+	+
<b>uORF</b>	+	+	+
<b>MBE</b>	-	-	+
<b>CPE</b>	-	+	+
<b>ARE</b>	-	-	-
<b>RTS</b>	-	-	-
<b>EDEN</b>	-	-	-
<b>M1-motif</b>	-	-	+
<b>TCE</b>	-	-	-
<b>NRE</b>	-	-	-
<b>TRE</b>	-	-	-
<b>IRE</b>	-	-	-
<b>PDE</b>	-	-	-
<b><i>lin-4</i></b>	+	+	+
<b><i>miR-1</i></b>	-	-	-
<b><i>miR-133</i></b>	-	-	-

<b>miR-206</b>	-	-	-
<b>miR-21</b>	-	-	-
<b>miR-26a</b>	-	-	-
<b>miR-27a</b>	-	-	-
<b>miR-214</b>	-	-	-
<b>miR-222</b>	-	-	-

### 3.3.3 *mlc2a* secondary structures

Bioinformatic tools have enabled the prediction of structures that occur naturally in the cellular environment intervening with the biochemical processes. mfold software provides several alternate foldings of DNA or RNA molecules. Inherent thermodynamic stability of the proposed structure motifs reflects differences in terms of free energy. Optimal folding of *mlc2a*-short, -medium and -long transcripts are depicted in Figures 3, 4 and 5 respectively. All three transcripts have similar secondary structures consisting of many loops and stems. Sequences characteristic of the transcription process are the TATA box, poly(A) signals, poly(A) tail and are marked in black color. AUG and UAA initiation and stop codons respectively, characteristic sequences of the translation process, are marked with pink color. dG for each molecule is indicated; -286.38, -470.10 and -458.54 kcal/mol for *mlc2a*-short, -medium and -long transcripts respectively. These results indicate that the medium transcript is the most thermodynamically stable. Several loops are formed in all three transcripts, especially in parts of the molecule where the underlying sequence is crucial for transcription or translation.

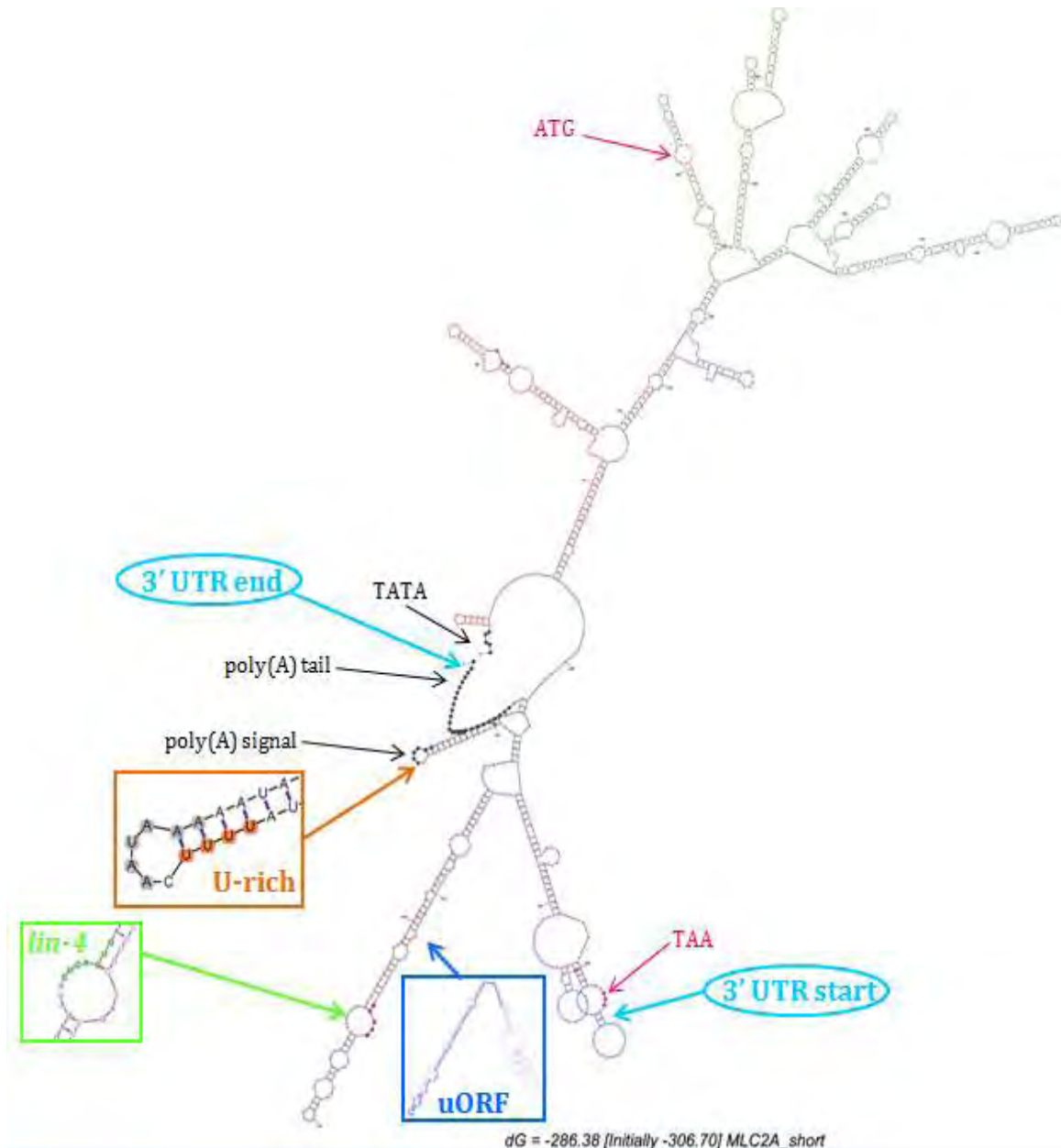
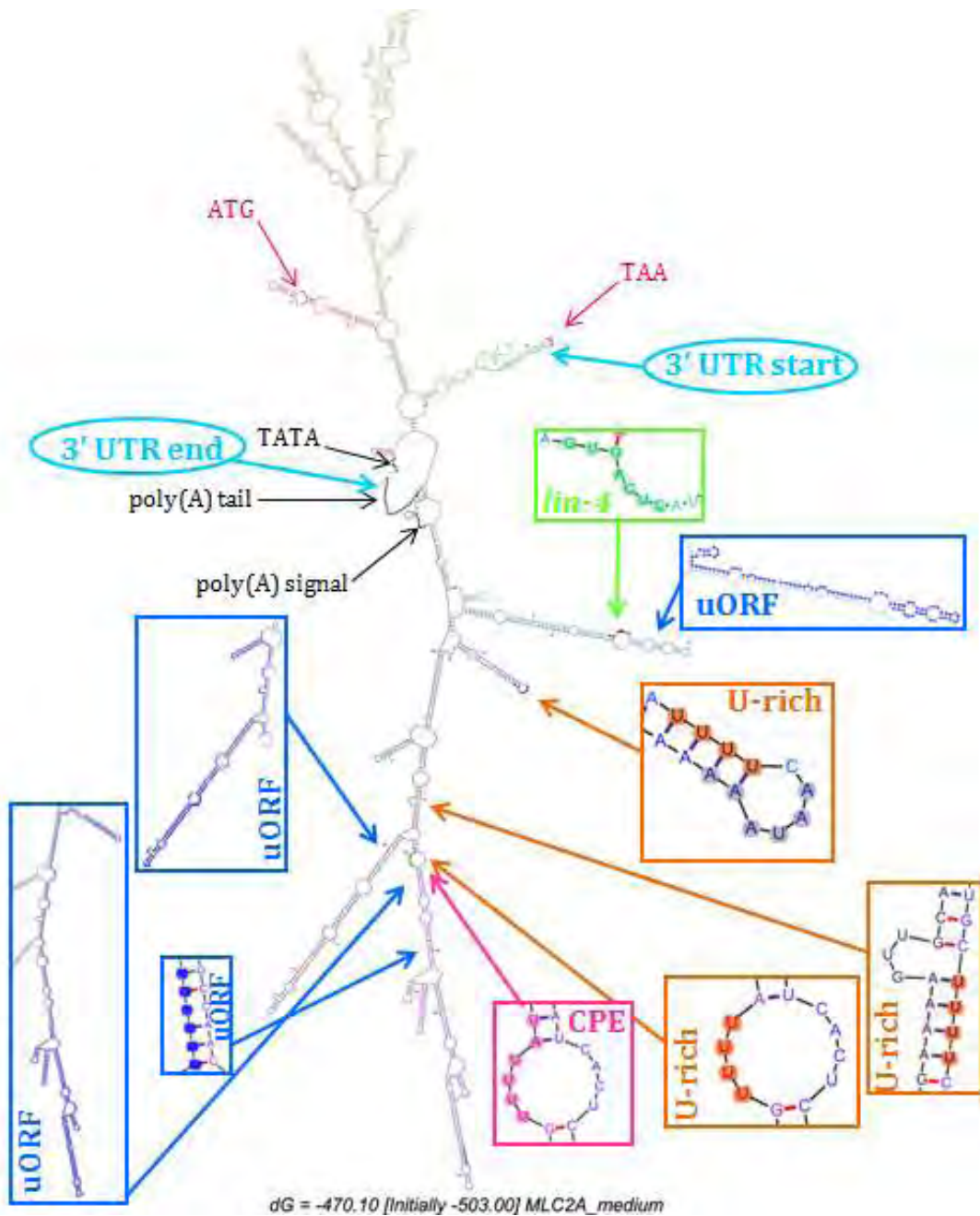

**Figure 3:** Predicted secondary structure for *mlc2a* short transcript. The color of the individual nucleotides illustrates the propensity to participate in base pairs and whether or not a predicted base pair is well-determined. Forty colors that range from red (unusually well-determined) to black (poorly determined) are used. The color in the connecting line of two base pairs indicates the free energy of a folding containing a base pair; black color depicts the minimum free energy and red, blue, green the progressively unfavourably formed base pairs. Start and end of the 3' UTRs are denoted in light blue circles respectively. Black arrows and black-coloured bases indicate TATA box, poly(A) tail and the poly(A) signal used. ATG and TAA (pink) indicate translation start and stop codons. *Cis*-regulatory elements uORF, *lin-4* and U-rich are denoted in dark blue-, light green- and orange-coloured bases, respectively.



*Chapter Σφάλμα! Χρησιμοποιήστε την καρτέλα "Κεντρική σελίδα", για να εφαρμόσετε το Heading 1 στο κείμενο που θέλετε να εμφανίζεται εδώ.*

---



**Figure 4:** Predicted secondary structure for *mlc2a* medium transcript. The color of the individual nucleotides illustrates the propensity to participate in base pairs and whether or not a predicted base pair is well-determined. Forty colors that range from red (unusually well-determined) to black (poorly determined) are used. The color in the connecting line of two base pairs indicates the free energy of a folding containing a base pair; black color depicts the minimum free energy and red, blue, green the progressively unfavorably formed base pairs. Start and end of the 3' UTRs are denoted in light blue circles, respectively. Black arrows and black-coloured bases indicate TATA box, poly(A) tail and the poly(A) signal used. ATG and TAA (pink) indicate translation start and stop codons. *Cis*-regulatory elements uORF, *lin-4*, U-rich and CPE are denoted in dark blue-, light green-, orange- and fuchsia-coloured bases, respectively.

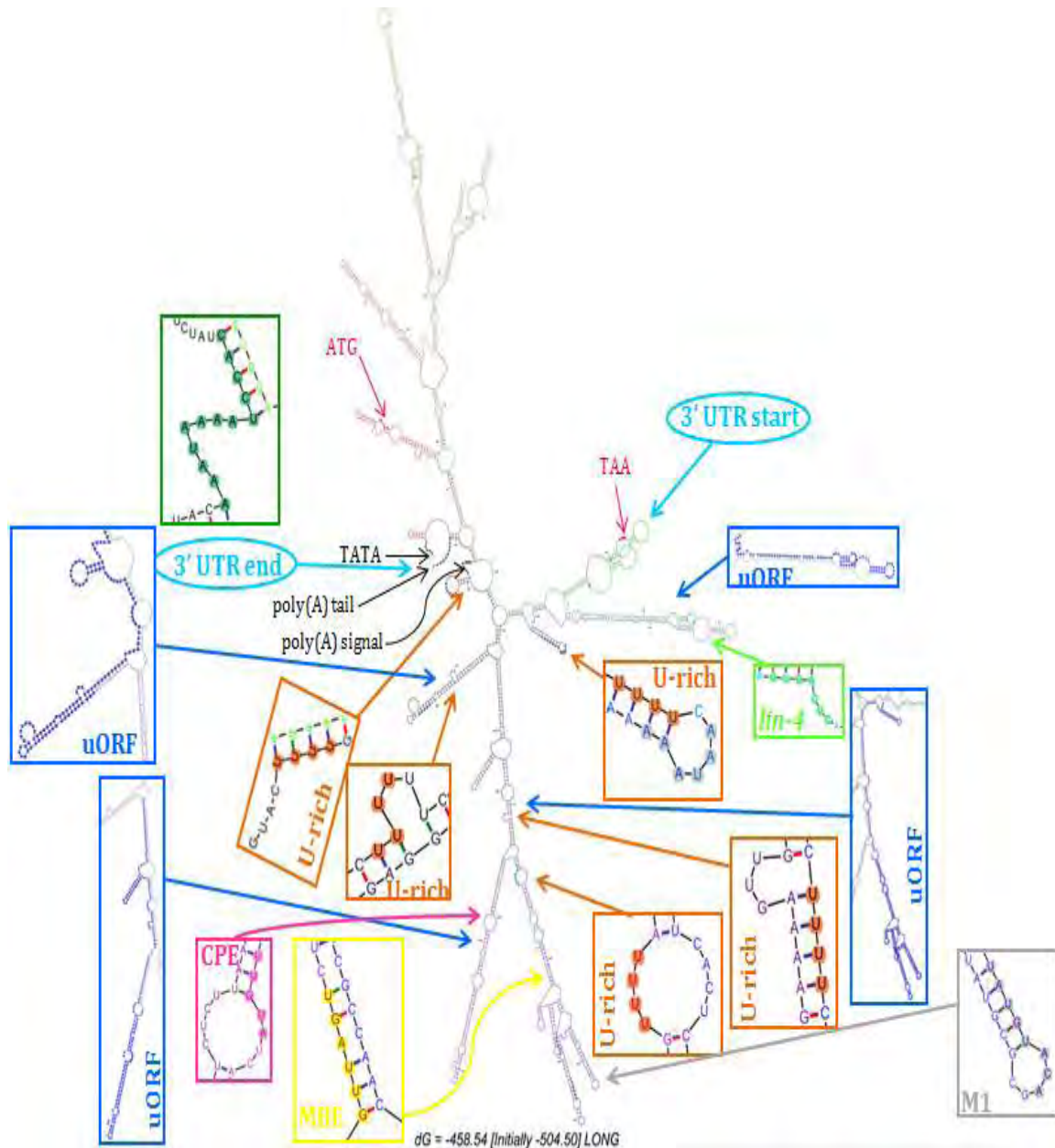

**Figure 5:** Predicted secondary structure for *mlc2a* long transcript. The color of the individual nucleotides illustrates the propensity to participate in base pairs and whether or not a predicted base pair is well-determined. Forty colors that range from red (unusually well-determined) to black (poorly determined) are used. The color in the connecting line of two base pairs indicates the free energy of a folding containing a base pair; black color depicts the minimum free energy and red, blue, green the progressively unfavorably formed base pairs. Start and end of the 3' UTRs are denoted in light blue circles, respectively. Black arrows and black-coloured bases indicate TATA box, poly(A) tail and the poly(A) signal used. ATG and TAA (pink) indicate translation start and stop codons. Cis-regulatory elements uORF, *lin-4*, U-rich, CPE, M1 motif and MBE are denoted in dark blue-, light green-, orange-, fuchsia-, grey- and yellow-coloured bases, respectively.

### 3.3.4 *mlc2a* 3' UTRs modify gene expression *in vitro*

In order to study whether alternative 3' UTRs modify gene expression *in vitro* a luciferase reporter assay was performed following transfection of the non-myogenic CHO cell line with plasmid constructs of carrying either *mlc2a*-short, *mlc2a*-medium or *mlc2a*-long 3' UTR. Cells transfected with the *mlc2a*-long or *mlc2a*-medium 3' UTR exhibited higher luciferase activity than the cells bearing the *mlc2a*-short ( $P < 0.0001$ , Figure 6). Cells co-transfected with both *mlc2a*-medium and *mlc2a*-long 3' UTRs constructs displayed the highest luciferase activity ( $P < 0.0001$ , Figure 6). When *mlc2a*-medium and *mlc2a*-long cells were co-transfected with *mlc2a*-short 3' UTRs constructs luciferase activity was significantly abolished ( $P < 0.0001$ , Figure 6).

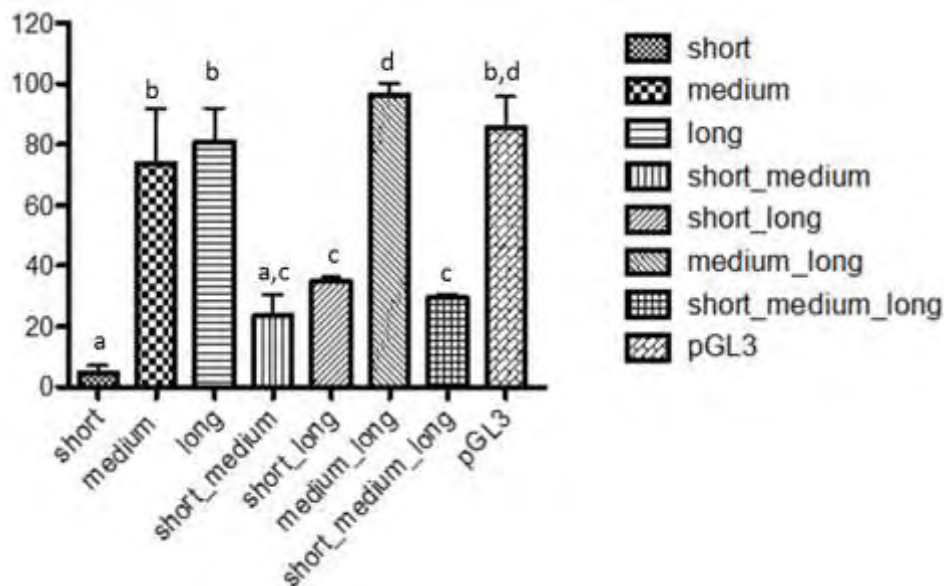

**Figure 6:** Transient expression of firefly luciferase gene in CHO cell cultures. Assays were performed 72 h after transfection. Luciferase activity of *mlc2a*-short, *mlc2a*-medium, *mlc2a*-long and co-transfections of the each combination of constructs was normalized using GraphPad Prism 6. Values given are means of 3 independent cultures  $\pm$  SEM. short, medium and long represent the short, medium and long transcripts respectively, short+medium represent the cells co-transfected with the short and medium transcripts, short+long represent the cells co-transfected with the short and long transcripts, medium +long represent the cells co-transfected with the medium and long transcripts, short+medium+long represent the cells co-transfected with the short, medium and long transcripts. a, b, c, d indicate significance at  $P < 0.05$ .

### 3.4 Discussion

*In silico* identification of sequences in 3' UTR regulating mRNA turnover and prediction of their secondary structures were reported for *mlc2a* alternative transcripts. Sequence analysis of the 3' UTRs and structure prediction using bioinformatics tools was described for rat a-myosin heavy chain 3' UTR (Niksevic et al. 2000), mouse (Kiri & Goldsprink 2002) and for human fast skeletal *mlc2* (HSRLC, Sachdev et al. 2003). HSRLC is encoded by a single copy gene in the human genome and is expressed in fetal and adult skeletal muscle. 3' UTR is 91 nts long and shares very low similarity to gilthead sea bream *mlc2a* (AF150904). AU-rich elements that regulate transcript stability were found in HSRLC 3' UTR but they were absent from *mlc2a* alternative transcripts of gilthead sea bream. Divergence between 3' UTRs between human and other species (fish species are not included) was also stressed by the authors. No alternative spliced forms have been identified for HSRLC. Secondary structure of the HSRLC 3' UTR was predicted with the mfold algorithm (as in the case of gilthead sea bream *mlc2a* alternative transcripts) to contain stems and loops. The sequence corresponding to 3' UTR end falls into a loop in both human and gilthead sea bream predicted structures.

#### 3.4.1 3' UTRs: structures, regulation and biological significance

Length of the 3' UTR influences not only the stability of the transcript but is also involved in the complex post-transcriptional regulation regarding sub-localization, transport and translational efficiency of the mRNA molecule (Di Giammartino et al. 2011; Mueller et al. 2013). Shorter or longer 3' UTRs are produced depending on the polyadenylation signal selected by the transcriptional molecular machinery. In the case of *mlc2a*, three polyadenylation signals were found to produce three alternative transcripts with 284 bp, 788 bp and 876 bp-long 3' UTRs, respectively. Long alternative transcript possesses two unique polyadenylation signals. mRNA cleavage and simultaneous poly(A) tail synthesis takes place 10-30 nts downstream the polyadenylation signal (Colgan & Manley 1997) suggesting that the last polyadenylation signal is utilized (Mueller et al. 2013). Furthermore, the existence of additional unusual polyadenylation signals shared between *mlc2a*-medium and -long transcripts may provide an extra level of polyadenylation regulation. In humans the unusual forms of polyadenylation sites are not

efficiently processed, making them “weaker” signals used for regulatory purposes (Beaudoing et al. 2000). The recruitment or abundance of the trans-acting factors and the RNA sequence flanking the polyadenylation signal determine whether a proximal or a distal polyadenylation signal will be preferred. A U/GU-rich sequence is located approximately 30 nts downstream of the polyadenylation signal in which CstF binds (DiGiammartino et al. 2011) indicating the preferable site for cleavage. In *mlc2a* transcripts U-rich sequences were found upstream of the polyadenylation signals used indicating that there may be another mechanism regulating polyadenylation site selection in gilthead sea bream. It is possible that the polyadenylation signal used is preferred for its conformational properties. All three polyadenylation signals used in the three transcripts fall into loops (Figures 3, 4, 5), protruding from the main axis of the structure, probably mediating the recruitment of the multiprotein polyadenylation machinery.

Post-transcriptional control and in particular mRNA turnover is largely influenced by *cis*-acting regulatory elements residing in the 3' uncoding regions. These regulatory motifs are occupied by *trans*-acting factors such as RNA-binding proteins and/or miRNAs resulting in mRNA instability or translational repression (diGiammartino et al. 2011; Alonso 2012). The extent and the distribution of these regulatory elements along the 3' UTR determine degradation patterns (Alonso 2012). *mlc2a*-short possesses just one *cis*-acting element that promotes degradation, uORF, compared with the four uORFs found in medium and long transcripts. Medium and long transcripts also contain the cytoplasmic polyadenylation element (CPE) that was documented to control translation, mostly by down-regulating it, in yeast and *Xenopus* (Moor & Richter 1999; Vilela et al. 1999). Besides the four uORFs and the CPE *mlc2a*-long shares with *mlc2a*-medium, *mlc2a*-long contains a Mushashi binding element (MBE). MBE has been implicated in the translational activation of maternal RNAs in *Xenopus* (Arumugam et al. 2010) and in facilitating repression of MBE-containing mRNAs in mammalian somatic cells (Nickerson et al. 2011). In addition, the presence of more U-rich sequences, which are known to promote mRNA decay (Alonso 2012), provide evidence that *mlc2a*-long may suffer higher instability than *mlc2a*-medium.

It has been suggested that longer 3' UTRs possess more signals and are more prone to degradation due to their instability (diGiammartino et al. 2011; Alonso 2012). More *cis*-acting regulatory elements predicted in medium and long transcripts possibly infer greater instability in these transcripts compared to the short transcript. A cellular mechanism to compensate degradation and inhibition of translation could be to augment transcriptional

activity as in the case of increased transcriptional activity reflected in enhanced luciferase activity of *mlc2a*-medium and *mlc2a*-long constructs compared with the short construct. Indeed, constructs of medium and long transcripts that bear more translational repression *cis*-acting elements were transcribed at much higher rates than those of the short transcript, pointing to the existence of a mechanism that compensates for reduced stability.

mRNA localization to sub-cellular compartments is also dictated by *cis*-acting motifs (Kislauskis & Singer 1992). In yeast M1 motif that was found in *mlc2a*-long, drives mRNAs to the mitochondrial surface (Shalgi et al. 2005), suggesting that *mlc2a* alternative transcripts may have alternate sub-cellular destinations. Compartmentalization of alternative transcripts empowers the efficiency of translation; proteins are synthesized in the exact place that they are going to be used. White skeletal muscle in fish has few mitochondria that interrupt the arrays of myofibrils (Kießling et al. 2006), which makes them special sub-cellular locations. Thus, it is possible that the *mlc2a*-long is the predominant *mlc2a* transcript for myosin molecules located in close vicinity to the mitochondria. Localization of slow and fast MHC in rat skeletal muscle fiber periphery or its uniform distribution were also suggested to be determined by motifs residing in 3' UTRs which are not conserved between rat and mouse (Kiri & Goldsprink 2002).

Pivotal biochemical processes at the RNA level are guided by both primary and secondary structure mRNA structural motifs. Secondary structure of *mlc2a* alternative transcripts was predicted using mfold software. The recommended structures of all three transcripts include various loops, some of which may not be common in living organisms. Therefore, the user has to discriminate between optimal or suboptimal folding. Choosing for the secondary structure of the minimum free energy is the most thermodynamically accurate approach considering that the more the negative energy, the more energy is required to change the folding. Secondary structure of all three transcripts is similar consisting of many loops and stems. *mlc2a*-medium structure resembles more to *mlc2a*-long structure. All three share a big loop located almost to the center of the structure in which 5' and 3' UTRs are positioned. The biological significance of the plethora of loops still remains to be deciphered. In all three transcripts the sequence that forms the loop codes for transcriptional or translational signals TATA box and CAAT box, poly(A) signal, poly(A) tail transcription signals; initiation and stop codons of translation also fall into a loop (Figures 3, 4, 5). The same was observed for the *cis*-acting regulatory elements CPE and M1 (Figures 4 and 5). There is high possibility that these loops mediate an easy access to members of the

core gene expression mechanisms and provide the inner surface for recognizing and docking of the recruited factors. Similarly, hairpin loop with bulges in the predicted secondary structure of rat  $\alpha$ -MyHC 3' UTR was suggested to act as binding site for RNA-binding proteins (Niksevic et al. 2000). The same mode of interaction is observed in RNA polymerase that pauses immediately after a hairpin is formed, facilitating the dissociation of the nascent RNA and the enzyme (Berg et al. 2002).

The rich repertoire of *cis*-regulatory elements positioned in the 3' UTR is further enriched by miRNAs action (Fabian et al. 2010; Alonso 2012). *lin-4* target site, a translational inhibitor in *Drosophila* (Lee et al. 1993), was detected in all three alternative transcripts. The existence of *lin-4* binding sequence coupled with gene expression data in gilthead sea bream may indicate a role of miRNA action in the early life stages. Developmental transition from larval to adult stages is characterized by a successive transition in the two isoforms of myosin light chain 2, with *mhc2a* expression marking the pre-metamorphic stages and *mhc2b* prevailing afterwards (Chapter 2). The expression shift in *mhc2* isoforms may be also shaped by *lin-4* action in *mhc2a* 3' UTRs attenuating their expression. However, no such experimental evidence is still available. Interestingly, none of the known muscle-specific miRNAs were identified in *mhc2a* 3' UTRs. The miRNAs searched herein are conserved among animal species displaying differential expression profiles in common carp development (Yan et al. 2012). The absence of binding sequences of these miRNAs on *mhc2a* alternative transcripts could be attributed to either species-specific differences in the regulation of myogenic program or low degree of conservation of miRNAs between common carp and gilthead sea bream.

mRNA transcription, translation and localization appear to be finely tuned in teleosts demonstrated by experimental evidence. In carp two genes coding for myosin heavy chain (MHC) were expressed in early embryogenesis and replaced by juvenile/adult isoforms two weeks post hatching in fast muscle. *In situ* hybridization showed that the mRNAs coding for these two genes are localized adjacent to the myosepta, in the site of the new sarcomere assembly. Bioinformatic analysis revealed a *cis*-regulatory sequence, possibly guiding their localization (Ennion et al. 1999). The first MHC isoform found in carp fast white muscle was expressed in the very small diameter fibers of the adult myotome, and it was associated with adult mosaic hyperplastic growth (Ennion et al. 1995). Expression levels of juvenile fast-MHC isoforms that differ in both coding sequence and 3' UTR were found to be controlled by temperature in carp (Imai et al. 1997). Furthermore, a-



MHC mRNA subcellular localization was tightly coupled with contractile myocyte activity in neonatal rat cardiac myocytes; in actively contracting myocytes  $\alpha$ -MHC mRNA and protein are found throughout the cytoplasm but in resting myocytes that are translationally blocked, mRNA is distributed perinuclearly (Goldspink et al. 1997).

Gene expression and the regulatory mechanisms governing it can be studied using cell cultures. Transient or stable transfection of foreign DNA results in transient or stable cell lines. The key difference between them is whether or not genetic material has successfully, fully integrated into host's genome and is constitutively expressed or not (Kim & Eberwine 2010). The transient transfection mode used here enables the immediate expression of the inserted DNA element in larger volumes soon after its introduction. In addition, in transient cell lines issues such as position effects due to random integration into the host's genome or epigenetic modifications of foreign DNA are avoided.

The choice of the appropriate cell line is also of great importance. Differential expression efficiency of *mlc2a* 3' UTRs in the non-myogenic environment of CHO cell line was due to differences in the interaction of the secondary structures adopted by the mRNA molecules with the basal transcription factors of the core regulation mechanism, without myogenic factors contributing in the regulation. CHO cell line was utilized as it is the preferred cell line for protein production yielding high protein amount (Bailey et al. 2012). The highest luciferase expression was observed in cells transfected with *mlc2a*-medium and *mlc2a*-long 3' UTR constructs. Truncated transcripts are known to be favored under the high gene expression rates of cells for producing more protein in a cell culture (Mueller et al. 2013) and less *cis*-acting down-regulating elements have been predicted in *mlc2a*-short 3' UTR. However, *mlc2a*-short 3' UTR was expressed at the lowest levels. Translation efficiency and post-transcriptional modifications of mRNA molecules with longer 3' UTRs are dependent on the foldings mRNAs can adopt. Overall, *mlc2a*-medium and *mlc2a*-long transcripts appeared to be more thermodynamically stable than *mlc2a*-short and therefore their expression was more thermodynamically favored as proved by the increased expression of luciferase levels compared to the short transcript. Moreover, It was recently proposed that in the myogenic environment 3' UTR length heterogeneity differs upon myogenic determination, proliferation, differentiation, migration and fusion of precursor cells to form multinucleated muscle fibers; 3' UTR length is limited until the differentiation phase and then is increased again (Mueller et al. 2013). In addition, alternative

polyadenylation occurring in muscle tissue appeared to produce longer 3' UTRs during differentiation of the C2C12 myoblasts into myotubes (Ji et al. 2009).

Enhanced luciferase activity of the *mlc2a*-long contradicts gene expression data in muscle tissue and cells where the *mlc2a*-short transcript is largely expressed (Chapter 2). The discrepancy observed could be attributed to the nature of the molecules tested; only the 3' UTR was incorporated in the cell constructs in sharp contrast to the gene expression profiles study where the whole transcript (coding region plus 5' and 3' UTRs) was present. Alternatively, the difference could be due to the cell line used. Expression of the transcript with the shorter 3' UTR prevails in the myogenic environment of white muscle under the regulation of myogenic factors that are absent from the mammalian ovary cell line. *mlc2a*-short may be the transcript of choice in the highly dynamic environment of differentiation and development due to its thermodynamic instability; differentiation runs in fast pace and gene regulation mechanisms must follow that pace. Under such conditions, an instable transcript could be removed more quickly than a stable one, and cancellation of protein synthesis would be immediate. Similarly, a high number of instable transcripts would be required on high demand of the peptide they encode for, and specific transcription factors – like myogenic factors – would be responsible for keeping high the production of the instable transcript. Transcript levels bearing shorter 3' UTRs were also found to be up-elevated during proliferation that is a fast evolving procedure (Mueller et al. 2013); in the early life stages that *mlc2a*-short prevailed, myocyte proliferation was also high.

Alternatively, the instable short transcript could serve as a negative regulator in the myogenic environment. The high transcriptional rates of the short transcript indicated by Q-PCR results in developing larvae and primary myocytes culture (Chapter 2); the high transcriptional rates of sole medium and long constructs in CHO cells; the reduced transcriptional activity of the co-transfected cells with short and either medium or long transcript point to a delicate negative regulation of the expression control of alternative transcripts. In the highly changing myogenic environment, short transcript might regulate gene expression of the other two transcripts and therefore needs to be highly abundant down-regulating the expression of both medium and long transcripts. In non-myogenic CHO cells transfected with either medium or long constructs in the absence of the short construct, this negative control imposed by the short construct was abolished and both medium and long constructs were largely expressed, whereas co-transfection with the *mlc2a*-short construct resulted in reduced luciferase activity in every case. It remains to be

investigated whether the myogenic environment would differentiate the picture seen in CHO cell line.

Co-transfection with two or all three 3' UTR constructs was used as an experimental model to study the dynamic preference over 3' UTR structures within cells and any possible interaction between the alternative transcripts. However, the levels of luciferase activity recorded by co-transfected cells with two or the three constructs did not indicate a preference over one of the transcripts, since luciferase activity of the co-transfected cells with *mlc2a*-medium and *mlc2a*-long constructs surpassed luciferase levels of *mlc2a*-short, *mlc2a*-medium or *mlc2a*-long alone. CHO transcriptional and translational machinery displayed a clear preference over the co-transfected *mlc2a*-medium and *mlc2a*-long constructs rather than each construct separately. Since medium and long transcripts displayed comparable expression levels in either myogenic or CHO environment, why does the cell need both alternative transcripts? There is high possibility that both transcripts have alternate intracellular fates. mRNAs not currently used by the translational protein machinery may accumulate in cytoplasmic foci called P-bodies (Parker & Sheth 2007). Under the appropriate stimuli, mRNAs can exit P-bodies and re-enter translation in polysomes, as observed in mRNA molecules within yeast P-bodies (Bregues et al. 2005). In this scenario, long or medium transcripts could be stored transiently in P-bodies until cell decisions about proceeding to degradation or return to translation are made. This scenario could also explain the low transcription rate of either medium or long transcript observed in developing larvae and in primary myocytes: storing in P-bodies would save cell energy from producing new transcripts while increase translational availability in the times of need during muscle protein synthesis. Compartmentalization is further indicated in the long transcript: M1 localization motif predicted only in the long 3' UTR driving long transcripts might drive them in close vicinity with mitochondria. Compartmentalization and localization in different sub-cellular organelles could also increase mRNA half-life in the cell and increase translational efficiency while preventing mRNA degradation.

Overall, alternative transcripts of *mlc2* can make a useful paradigm of the highly appreciated the last years 3' untranslated region and provide information regarding the role of the secondary structure in mRNA turnover and the elements harboring it in collaboration with auxiliary trans-acting factors binding.

*Chapter Σφάλμα! Χρησιμοποιήστε την καρτέλα "Κεντρική σελίδα", για να εφαρμόσετε το  
Heading 1 στο κείμενο που θέλετε να εμφανίζεται εδώ.*

---

*Chapter Σφάλμα! Χρησιμοποιήστε την καρτέλα "Κεντρική σελίδα", για να εφαρμόσετε το  
Heading 1 στο κείμενο που θέλετε να εμφανίζεται εδώ.*

---

## ***Chapter 4***

*Chapter Σφάλμα! Χρησιμοποιήστε την καρτέλα "Κεντρική σελίδα", για να εφαρμόσετε το  
Heading 1 στο κείμενο που θέλετε να εμφανίζεται εδώ.*

---

## **Chapter 4**

### ***Developmental regulation of Myosin Light Chain 2 in gilthead sea bream (*Sparus aurata* L.) and correlation with muscle growth markers***

#### **4.1 Introduction**

Muscle develops and grows through two fundamental processes: the recruitment of new fibers (hyperplasia) and the increase in size of existing fibers (hypertrophy) (reviewed by Rowleron & Veggetti 2001). The two processes are differentially regulated throughout the lifecycle in teleosts; hyperplastic growth dominates the initial stages of development whereas hypertrophy takes over later on. Post-metamorphosis, teleost muscle grows by a process called mosaic hyperplasia in which myogenic progenitor cells (MPCs) are recruited to fuse and form new myotubes or to contribute to the expansion in size of existing muscle fibers. The result is the generation of muscle fibers of varying diameter that create the mosaic appearance of the mature teleost musculature (reviewed by Rowleron & Veggetti 2001). The axial musculature or fillet may account for up to 70 % of the fish body mass (Bone 1978) and is made up of serial myotomes of muscle fibers, mainly fast white fibers (reviewed by Rowleron & Veggetti 2001; Steinbacher et al. 2006; Rescan 2008). Improving muscle mass and quality is a major goal currently in aquaculture research and identifying the molecular mechanisms underlying this process will provide molecular markers for genetic selection and is the first step towards efficient management of growth.

White muscle cellularity (number and size of muscle fibers) is a highly plastic process that depends on species or strain (fast growers vs slow-growers, Valente et al. 1999; Ostaszewska et al. 2008), exercise, environment (e.g. embryonic temperature) and feeding (Johnston et al. 1999, 2008), follows seasonal cycle patterns and is largely based on the stage of development (reviewed by Johnston et al. 1999). Most importantly, muscle cellularity has been tightly linked to the growth potential and the final size fish may attain. For example Weatherley and colleagues (1988) compared ten different fish species and found growth capacity largely depended on the maintenance of white muscle fiber recruitment and the number of small-diameter fibers. Similarly, four isolated morphs of Arctic charr (*Salvelinus alpinus*) in lake

Thingvallavatn, Iceland, significantly differed in their final size according to the number of white muscle fibers (Johnston et al. 2004), while genetically modified Arctic charr carrying an extra growth hormone gene had significantly higher numbers of white muscle fibers compared with non-genetically modified fish of either the same age or the same size (Pitkänen et al. 2001).

The generation and enlargement of muscle fibers requires the synthesis and deposition of sarcomeric proteins that make up the bulk of differentiated muscle cells. Myosin is a major sarcomeric protein and consists of two heavy chains (MHCs) and four light chains (MLCs) combined in a long coiled  $\alpha$ -helical tail and two heads. MHCs and MLCs exist in multiple isoforms that can exhibit both tissue-specific and stage-specific patterns of expression (Whalen et al. 1981; Gauthier et al. 1982), and are regulated by hormonal status and environmental cues (Hirayama et al. 1998; Moutou et al. 2001). Evidence from several aquaculture species revealed that myosin chains are also regulated by nutrition and their abundance correlated to protein accretion. For example, inclusion in the diet of high levels of fish protein hydrolysate (FPH) in Atlantic salmon caused higher myosin heavy chain expression levels and muscle protein accretion compared with fish fed on medium FPH inclusion (Hevroy et al. 2006). Furthermore, in fasted and refed Atlantic salmon, MLC2 was differentially expressed over a 32-day refeeding period (Bower et al. 2009). In rainbow trout dietary levels of protein caused significantly different expression levels of myosin heavy chain over a six-week feeding period (Overturf & Hardy 2001) and a diet rich in soybean meal significantly increased the expression of fast-MHC (Alami-Durante 2010b). In Senegalese sole (*Solea senegalensis*), MLC2 was significantly down-regulated with increasing dietary lipid level (Campos et al. 2010). Proteomics analysis of white muscle of gilthead sea bream revealed a significantly higher expression of myosin chains (MLC2) in wild compared with farmed individuals (Addis et al. 2010).

In gilthead sea bream, two isoforms of MLC2 that encode a 170 aa peptide have been isolated and characterized from white muscle (Moutou et al. 2001; Georgiou et al. in submission). Three alternative transcripts of MLC2A have been isolated, which are products of alternative polyadenylation site selection and encode for the same peptide but differ in the length of their 3' UTRs (284bp, MLC2A-S; 788bp, MLC2A-M; 876bp, MLC2A-L). The two MLC2 isoforms appear to exhibit different expression patterns during development and in primary muscle cell cultures. Transcripts of MLC2A are detectable at the onset of somitogenesis and remain high during embryonic and stratified hyperplasia but are downregulated around metamorphosis (Chapter 2). MLC2B expression starts before hatch and remains at very low levels up until metamorphosis. Similarly, in primary muscle cell cultures MLC2A was the



predominant isoform expressed and peaked at differentiation whereas MLC2B was expressed at significantly lower levels in all differentiation states (Chapter 2). In juvenile fish, the expression pattern of MLC2A and B is reversed and MLC2B is about 10-fold higher than MLC2A and they responded differently to growth hormone administration (Chapter 2).

The aim of the present study is to investigate how the expression of the two different MLC2 isoforms differs between hyperplastic and hypertrophic growth. Developmental stages of gilthead sea bream (*Sparus aurata*) lying between hatch and metamorphosis, when transitions from hyperplasia to hypertrophy are known to be abrupt and dramatic (Rowlerson & Veggetti 2001) were used to establish the relative abundance of the two MLC2 isoforms. The expression patterns of the two isoforms were correlated to axial growth and muscle cellularity measurements as well as the expression of other structural, regulatory and myogenic factor genes that govern the early stages of muscle development. The results of the present study are in agreement with earlier results (Chapter 2) with MLC2A being expressed in early developmental stages together with myogenic differentiation markers and with MLC2B being expressed post-metamorphosis and indicate that MLC2 isoforms may be useful molecular tools to monitor the growth phases of white muscle in gilthead sea bream.

## **4.2 Materials & Methods**

### *4.2.1 Fish and sampling stages*

Gilthead sea bream (*Sparus aurata* L.) larvae were obtained from a commercial hatchery at Maliakos Gulf, Greece. Larvae were held in filtered, continuously aerated sea-water (salinity 29 ppt) at a constant temperature of 19 °C. They were exposed to a light-dark cycle of about 10.5-13.5 h in early March and 13-11 h in April respectively, and fed regularly during the daylight period with an optimized diet for their developmental stages. Larvae were raised in cohorts of the same age from many batches of fertilized eggs.

Gilthead sea bream larvae were sampled on 5, 15, 25, 35, 45, 60 days post hatch (dph). Larvae were anaesthetized in 2-phenoxyethanol (1:5000, Sigma) and the total length of 50 larvae was measured individually with a semi-automatic image analyzer (ImageJ software, Abramoff et al. 2004). Larvae for morphometric analyses were dipped in Serra fixation buffer (ethanol 6V, formalin 3V, acetic acid 1V; Alami-Durante 1990). Samples for subsequent gene expression analyses were placed in RNAlater Reagent (Sigma) and held at -20 °C until use.

### *4.2.2 Morphometric analysis*

Training and establishment of the experimental protocol were conducted in INRA, Pôle d'Hydrobiologie in St Pée sur Nivelle, France under the supervision of Research. H  l  ne Alami-Durante with the help of Marriane Cluzeaud for the morphometric analyses and Didier Bazin for image analyses.

A novel fixation protocol was developed based on a previously published protocol by Alami-Durante (1990). Muscle morphometric analysis involved 10 fish from each 5, 15, 25, 35, 45 and 60 dph age group. Gilthead sea bream larvae of 5, 15 and 25 dph kept in butanol were pre-embedded in agar, and then dehydrated by immersion in ethanol series (for 5 minutes/ solution) of increasing concentration (0, 25 %, 50 %, 75 % and 100 %) with a final step in butanol in which samples were held until embedding in paraffin. Subsequently, inclusion of larvae in paraffin was carried out by incubation for a total of 1h (5, 15 and 25 dph larvae) or 2h (trunco-caudal region of 35, 45 and 60 dph larvae) in 4 changes of molten paraffin (58 °C).

Serial transverse sections (10  $\mu\text{M}$ ) were prepared using a microtome (Leica, R2125), pasted on slides and dried at 37 °C for 48 hours.

Sections were stained with Ehrlich haematoxylin and 1 % eosin (Alami-Durante et al. 2007) after dewaxing sections in toluene (two changes for 5 min) and rehydrating through a graded ethanol series (100 %, 75 %, 50 % and 25 %) and washing in distilled water. Stained sections of 10 individuals per age group were photographed with a light microscope (Leica, DM2000) and analysed using ImageJ software (Abramoff et al. 2004). Cellular analyses were performed in a whole epaxial quadrant of myotome located at the vent level per fish. This quadrant of white muscle consisted of newly formed muscle fibers and older ones, and was selected for cellularity measurements, i.e. muscle hypertrophy and hyperplasia. The outline of all individual white muscle fibers was drawn, and the fiber diameter (WFD; diameter of a circle with an area equal to the muscle fiber; hereafter referred to as "fiber diameter"), area (WFA), and perimeter (WFP) was determined. Quantification of maximal hypertrophy of white muscle was achieved by calculation of the mean fiber diameter. Total number of white fibers (TNWF) present in the dorsal quadrant of white muscle was determined for each fish. Sections of 5 dph larvae were of low quality for cellularity measurements and were excluded from the morphometric analysis.

#### *4.2.3 RNA extraction*

Total RNA was extracted from whole 5, 15, 25, 35, 48 and 58 dph larvae using TRI Reagent (Sigma) according to the manufacturer's instructions. Total RNA was subsequently subjected to DNase treatment with DNA-free (Ambion) to remove traces of genomic DNA and was stored in -80 °C until further use. cDNA synthesis was performed in one reaction for all samples to ensure the same reaction efficiency. cDNA was generated from 1  $\mu\text{g}$  of total RNA using 200 U/ $\mu\text{l}$  SuperScript II Reverse transcriptase (Invitrogen), 3  $\mu\text{g}$  random primers (Invitrogen) and 40 U/ $\mu\text{l}$  recombinant RNaseOUT Ribonuclease Inhibitor (Invitrogen) in a total reaction volume of 27  $\mu\text{l}$ .

#### *4.2.4 Relative quantification of gene expression by real-time PCR analysis*

The gene expression levels of the three MLC2A transcripts (MLC2A-L, MLC2A-M and MLC2A-S), MLC2B, myogenin (MYOG), myostatin 1 (MSTN1), follistatin (FST), insulin-like

growth factor I (IGFI) and collagen 1a1 (COL1a1) were determined (Table 1). Real-time PCR (Q-PCR) was conducted in an MXPro 2000 (Stratagene) in duplicate using the KAPA SYBR FAST qPCR (2x) (KAPA Biosystems). All reactions were set up using 150-300 nmol/L of each primer and 0.17 µg/µl cDNA (1:5 diluted) in a reaction volume of 20 µl. The following PCR conditions were used: an initial denaturation step at 95 °C for 3 min, 40 cycles of amplification (each cycle is 30 sec at 95 °C, 1 min at 61 °C, 1 min at 72 °C), followed by the dissociation curve step (1 min at 95 °C, 30 sec at 55 °C, 30 sec at 95 °C) to verify the amplification of a single product. Efficiency curves were obtained for each cDNA template by plotting CT values against the log<sub>10</sub> of six serial dilutions of a cDNA pool created from all samples analysed. Q-PCR efficiency (E) was calculated according to  $E=10^{-1/\text{slope}}$  (Pfaffl et al. 2002) and varied between 95 % - 100 %. A series of housekeeping genes (EF1α, β-actin, RPL13a, RPS18) were validated for use and were rated using the geNorm VBA applet (Vandesompele et al. 2002). The normalization factor was calculated as the geometric mean of the three most stably expressed housekeeping genes (β-actin, RPL13 and EF1a).

**Table 1:** Gene identity, accession number and the forward and reverse primers used for real-time PCR (Q-PCR) gene expression analysis.

Gene	Accession number	Forward primer	Reverse primer	Product size (bp)
<i>EF1a</i>	AF184170	TCAAGGGATGGAAGGTTGAG	AGTTCCAATACCGCCGAT	151
<i>b actin</i>	AF384096	CGACATCCGTAAGGACCTGT	ACATCTGCTGGAAGGTGGAC	205
<i>RPL13a</i>	CV133427	TCTGGAGGACTGTCAGGGCATGC	AGACGCACAATCTTAAGAGCAG	147
<i>RPS18</i>	AM490061	AGGGTGTGGCAGACGTTAC	GAGGACCTGGCTGTATTTGC	196
<i>MLC2A-L</i>	*	GGCATGACAGGAAAAGTTGC	TGAAAACAGGAGAGAAAACAGC	179
<i>MLC2A-M</i>	*	TCTCTGTCCCTGCCTCTTGT	TCTCTGTCCCTGCCTCTTGT	201
<i>MLC2A-S</i>	*	GCCCCATCAACTTCACCGTCTTT	GGTTGGTCATCTCCTCAGCGG	188
<i>MLC2B</i>	FG618631	TCCCTTTGCTATTCTGCCTTC	AAATCAGCCCTATTCCCATA	180
<i>MYOG</i>	EF462191	CAGAGGCTGCCAAGGTG	CAGGTGCTGCCGAAGTGGGC	181
<i>MSTN-1</i>	AF258448	TTTTTGGACACAACCGATCCA	GTGTGTGTGTTCCCTGCATCC	186
<i>MRF4</i>	N034421	AGCGGGGAKGAGCACGTCCT	ATGGCGCTGMGTAAAATCTCC	240
<i>FST</i>	AY544167	GTACCAGGGGAAGTGAAGA	GCATAGATGATCCCGTCGTT	167

*Chapter Σφάλμα! Χρησιμοποιήστε την καρτέλα "Κεντρική σελίδα", για να εφαρμόσετε το  
Heading 1 στο κείμενο που θέλετε να εμφανίζεται εδώ.*

---

<i>IGFI</i>	AY996779	TCTTCAAGAGTGCGATGTGC	GCCGTAGCCAGGTTTACTGA	184
<i>COL1a1</i>	DQ324363	AGACCTGCGTATCCCCAACTC	GCCACCGTTCATAGCCTCTCC	109

\* Accession number does not exist in NCBI (<http://www.ncbi.nlm.nih.gov/>) for the gene.

#### 4.2.5 *Statistical analyses*

Gene expression data were square-root transformed to meet the assumptions of normality and/or homogeneity. Morphometric and Q-PCR results are expressed as means  $\pm$  standard error of the mean (SEM). Morphometric data failed to fit Kolmogorov–Smirnov test for normality and were analysed using a non-parametric Kruskal–Wallis ANOVA median test (Zar 1996). When a significant difference was observed, further statistical analysis was performed by post-hoc non-parametric Dunn’s test in order to determine the influence of age on larvae development. The frequency distribution of  $<5 \mu\text{m}$  diameter of white muscle fibers was evaluated with Pearson’s chi-squared test (Zar 1996). Spearman’s rank correlation was run in order to assess the statistical dependence between two variables (Zar 1996). For all statistical tests, differences were considered to be significant from a value of  $P < 0.05$ . Data were analysed using the SigmaStat software (version 3.5; STATCON).

Supervised hierarchical clustering was applied (Eisen 2002) to Q-PCR analysis and each gene was classified according to its expression profile. TreeView software was used to generate a visual representation of the classification.

## **4.3 Results**

### *4.3.1 Morphometry*

The axial growth of gilthead sea bream larvae recorded as total length was linear between 5 - 60 dph ( $P \leq 0.001$ , Figure 1A). Total number of white fibers (TNWF), the distribution of their diameter, perimeter and area were recorded in a whole epaxial quadrant of *Sparus aurata* larvae. TNWF increased significantly between 15 - 35 dph, from 250 on 15 dph to 742 on 35 dph, to slow down in subsequent stages ( $P \leq 0.001$ , Figure 1A). White muscle fiber diameter distribution in all age groups was monophasic rather than biphasic, shifting to bigger fibers with age increment (Figure 1B). Hyperplasia was dominant between 15 and 25 dph as revealed by the high increase in TNWF and the lack of differentiation in the distribution of muscle fiber diameter (Figure 1A-B).

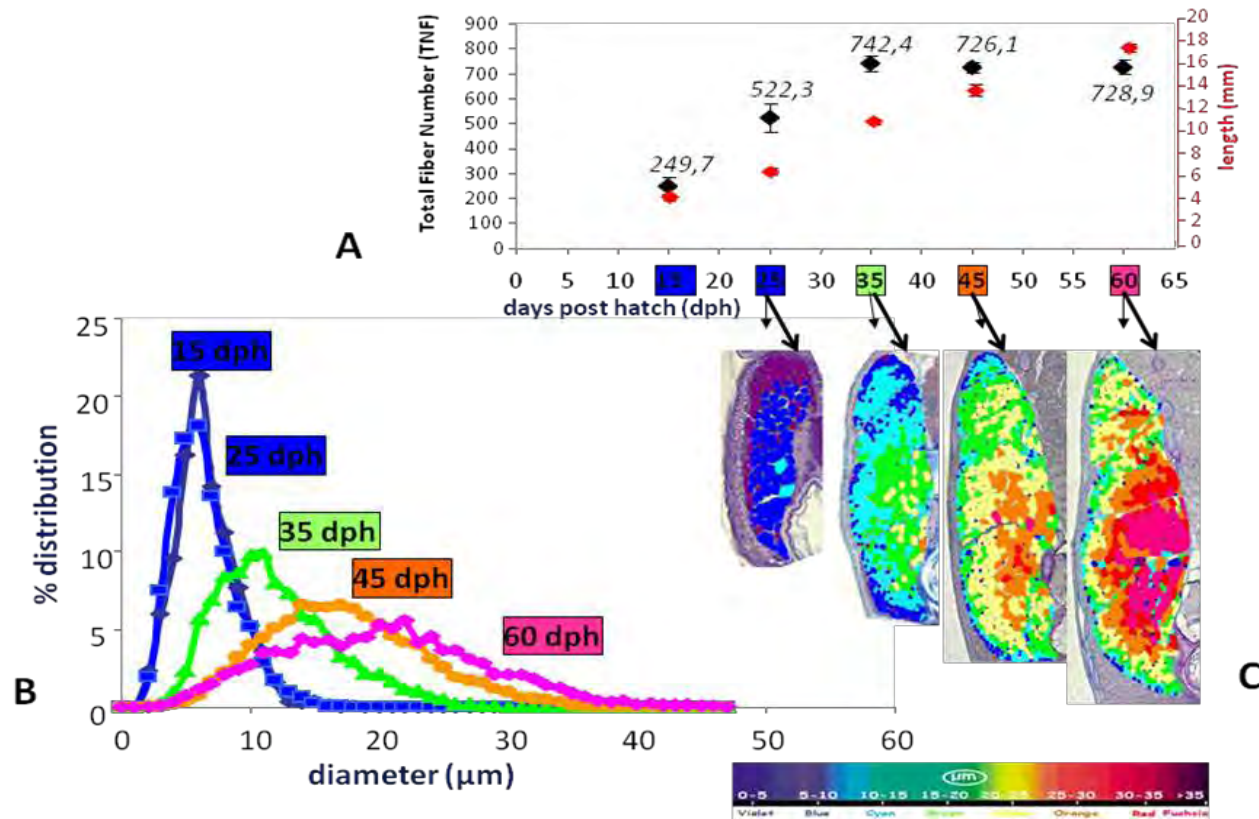

**Figure 1:** White muscle morphometry. **A.** Total length ( $N=50$ ) and total number of white muscle fibers ( $N=10$  larvae) with increasing age in gilthead sea bream larvae between 15 and 60 dph. Values are given as means  $\pm$  SEM; **B.** Distribution of white fiber diameter in a whole white muscle epaxial quadrant in gilthead sea bream larvae at 15, 25, 35, 45 and 60 dph larvae. **C.** Sections of a whole epaxial quadrant of gilthead sea bream larvae on 25, 35, 45 and 60 dph, respectively, showing the distribution of muscle fibers of differentiating diameter within the quadrant.



Furthermore, white muscle fibers with a diameter smaller than 5  $\mu\text{m}$  (WFD <5  $\mu\text{m}$ ) increased from 34 % in 15 dph larvae to its maximum value of 40 % in 25 dph larvae, and decreased thereafter to very low levels ( $P \leq 0.001$ , Figure 2A). Mean fiber diameter (WFD) doubled from 25 to 35 dph, to increase significantly again by 45 dph and 60 dph ( $P \leq 0.001$ , Figure 2B). Mean white muscle fiber perimeter (WFP) and area (WFA) did not change between 15 and 25 dph, yet there was a significant progressive increase after 25 dph (for both WFP and WFA  $P \leq 0.001$ , Figure 2C-D). As expected mean diameter was tightly correlated to mean area ( $R=1$ ,  $P=0.000$ ), and mean perimeter ( $R=0.990$ ,  $P=0.000$ ) as well as to total length ( $R=0.977$ ,  $P=0.000$ ) as indicated by Spearman rank correlation.

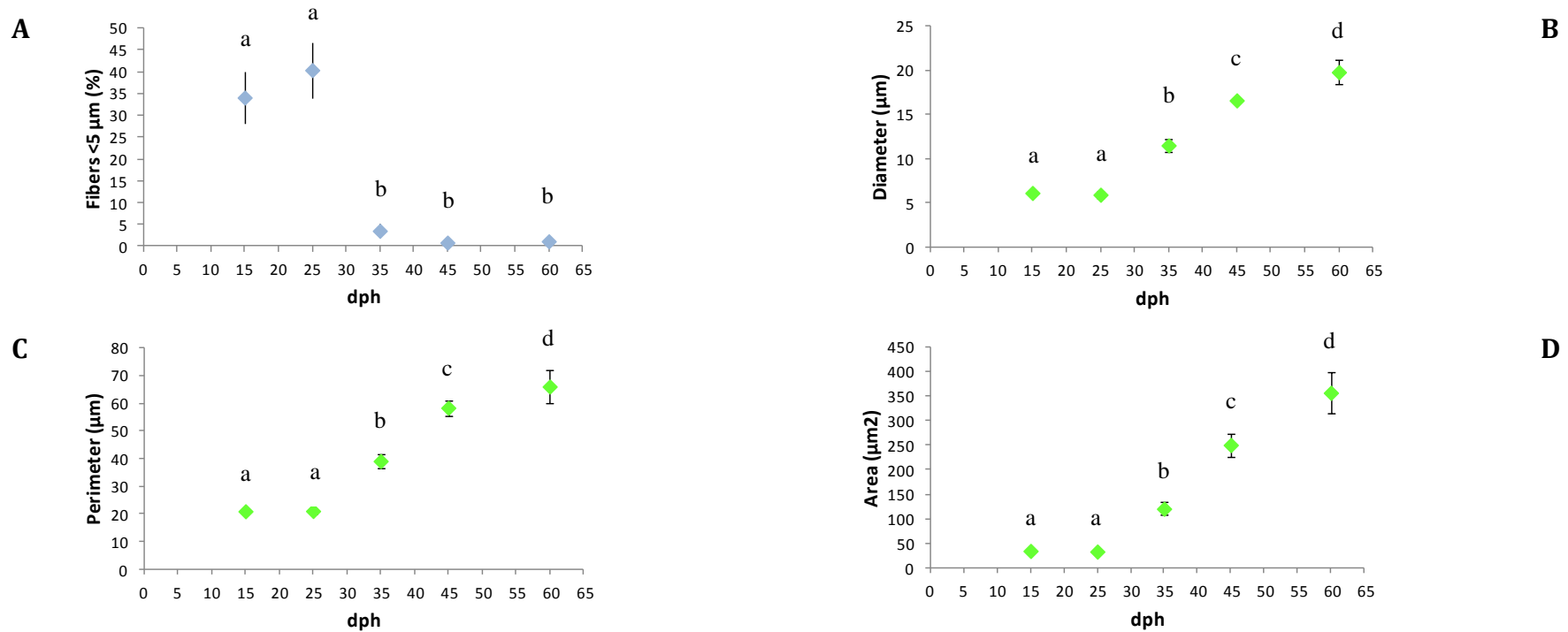

**Figure 2:** Frequency of fibers with diameter <5 μm (A), mean diameter (B), mean perimeter (C) and mean area (D) of white muscle fibers in gilthead sea bream larvae on 25, 35, 45 and 60 dph, respectively. Values are given as means ± SEM (N=10 larvae). a-d superscript letters indicate significant differences among the age groups (P<0.05).

#### *4.3.2 Developmental changes in the epaxial myotome of larvae*

Muscle cellularity was recorded at the level of the anal opening in gilthead sea bream larvae aged 15, 25, 35, 45 and 60 dph.

- *15 and 25 dph larvae*

At this developmental stage gilthead sea bream larvae have a weak swimming ability performing eel-like lateral undulatory movements. The predatory strategy is based on bursts of movement (Patrino et al. 1998). Stability and balance of the larvae is enhanced by the presence of the pectoral fin outline (Bone et al. 1995). From an anatomical view the horizontal septum splits up the myotome in epaxial and hypaxial myomeres. In most cases of the 15 dph larvae epaxial and hypaxial myotomes consisted of one myomere each but in a few larvae the epaxial myotome was separated into two myomeres. In 25 dph larvae the lateral muscle was formed of three to five myomeres epaxially and three or four myomeres hypaxially (Table 2). Myomeres of both 15 and 25 dph larvae had the typical W-shape arrangement of the mature myomere. In each myomere the distinction between white and red muscle was apparent from this very early age. In 15 dph larvae the lateral muscle consisted of a superficial monolayer of muscle fibers which was gradually replaced by red muscle fibers ventrally, close to the horizontal septum and in proximity to the lateral line nerve. This monolayer was most prominent in 25 dph gilthead sea bream. Underneath the superficial layer of muscle fibers the myotome was composed of layers of white muscle fibers, the size of which increased from both the dorsal apex to the horizontal myoseptum and from superficial extremities more adaxially in both 15 and 25 dph larvae, giving rise to stratified hyperplasia. White muscle fibers of very small diameter (fibers with mean diameter smaller than 5  $\mu\text{m}$ ) could be found in the most apical regions of the myotome. These immature fibers are indicative of the germinal zones that fuel hyperplasia (Patrino et al. 1998; Moutou et al. 2005).

**Table 2:** Number of epaxial and hypaxial myomeres in gilthead sea bream larvae. The epaxial and hypaxial germinal zone is apparent (+) or not (-). The number of + indicates the intensity of the hyperplastic response.

dph	Number of epaxial myomeres	Number of hypaxial myomeres	Epaxial germinal zone	Hypaxial germinal zone
15	1 or 2	1	+++	+++
25	3 or 4 or 5	3 or 4	+++	+++
35	3 or 4 or 5	3 or 4	+	+
45	3 or 4 or 5	3 or 4 or 5	-	-
60	5 or 6	5 or 6	-	-

- *35 dph larvae*

35 dph larvae had a more developed neuro-musculo-skeletal system. This pre-metamorphic stage is characterized by noteworthy anatomic changes. The flexion of the caudal fin is already developed as well as the neo-formed swim bladder. These appendixes altogether provide a better locomotor ability enhancing the propulsion of the larvae although locomotion is still mostly based on eel-like movements (Patrino et al. 1998). With regard to the myomere organization, the W-shape of the myomeres was well defined. The number of myomeres was three to five dorsally and three to four ventrally (Table 2). Fiber size distribution analysis in 35 dph larvae revealed an overall growth of the dorsal epaxial quadrant that exhibited a four-fold increment in mean area ( $P \leq 0.001$ ) and a two-fold increase in mean diameter ( $P \leq 0.001$ ) and mean perimeter ( $P \leq 0.001$ ) compared to 25 dph larvae (Figure 2). The germinal zones of small diameter white fibers in the dorsal and ventral regions of the myotome were still evident but the percentage of white muscle fibers smaller than 5  $\mu\text{m}$  was significantly decreased ( $P \leq 0.001$ , Figure 2A).

- *45 dph larvae*

45 dph larvae were initiating metamorphosis that is a crucial event in fish development. The overall macrostructure features were similar to previous stages. Swimming behaviour shifted towards propulsion through lateral movements of the tail and the larvae performed less undulatory eel-like movements. The number of epaxial and hypaxial myomeres ranged from

three to five with the ratio of hypaxial to epaxial deviating from 1 (Table 2). Myomere growth occurred by hypertrophy as indicated by the two-fold increase in mean area ( $P \leq 0.001$ ) and an overall significant increase of mean diameter ( $P \leq 0.001$ ) and mean perimeter ( $P \leq 0.001$ ) of fibers between 35 and 45 dph larvae although the total fiber number was not significantly changed. The germinal zones in myotome apices were no longer evident. This developmental stage had the fewest small-diameter white fibers localized in the apical regions.

- *60 dph larvae*

Remarkable differences in myotome appearance were evident in the first interval immediately after metamorphosis. Epaxial and hypaxial quadrants were separated by five or six myomeres (Table 2). A superficial monolayer of red muscle overlaid, and was readily distinguished from the deep white muscle. In the latter tissue, a new hyperplastic process emerged with recruitment of immature small diameter fibers that were dispersed in the epaxial quadrant and were not limited to previously identified proliferative zones. The interspersed small diameter white fibers among mature white fibers gave rise to mosaic hyperplasia, a typical post-metamorphic feature. Mean area ( $P \leq 0.001$ ), mean perimeter ( $P \leq 0.001$ ) and mean diameter ( $P \leq 0.001$ ) were all significantly elevated compared with 45 dph gilthead sea bream larvae (Figure 2).

#### *4.3.3 Gene expression patterns*

The expression of structural genes, myogenic and hormonal factors was monitored alongside with the cellular changes of the developing white muscle in gilthead sea bream larvae. MLC2A was the most abundant isoform ( $P < 0.001$ ) during the hyperplastic phase of muscle development (Figure 3A) and it was down-regulated ( $P < 0.001$ ) during hypertrophy. Expression of MLC2B isoform followed the reverse pattern; it was of low abundance during hyperplasia and it was up-regulated during hypertrophy (Figure 3A). Collagen 1a1 expression levels and pattern coincided with that of MLC2B. MLC2B expression was significantly lower than MLC2A at all times ( $P < 0.002$ ), making MLC2A the dominant isoform in early development. The expression of all three structural genes was significantly correlated during gilthead sea bream early development ( $P < 0.05$ , Table 3).

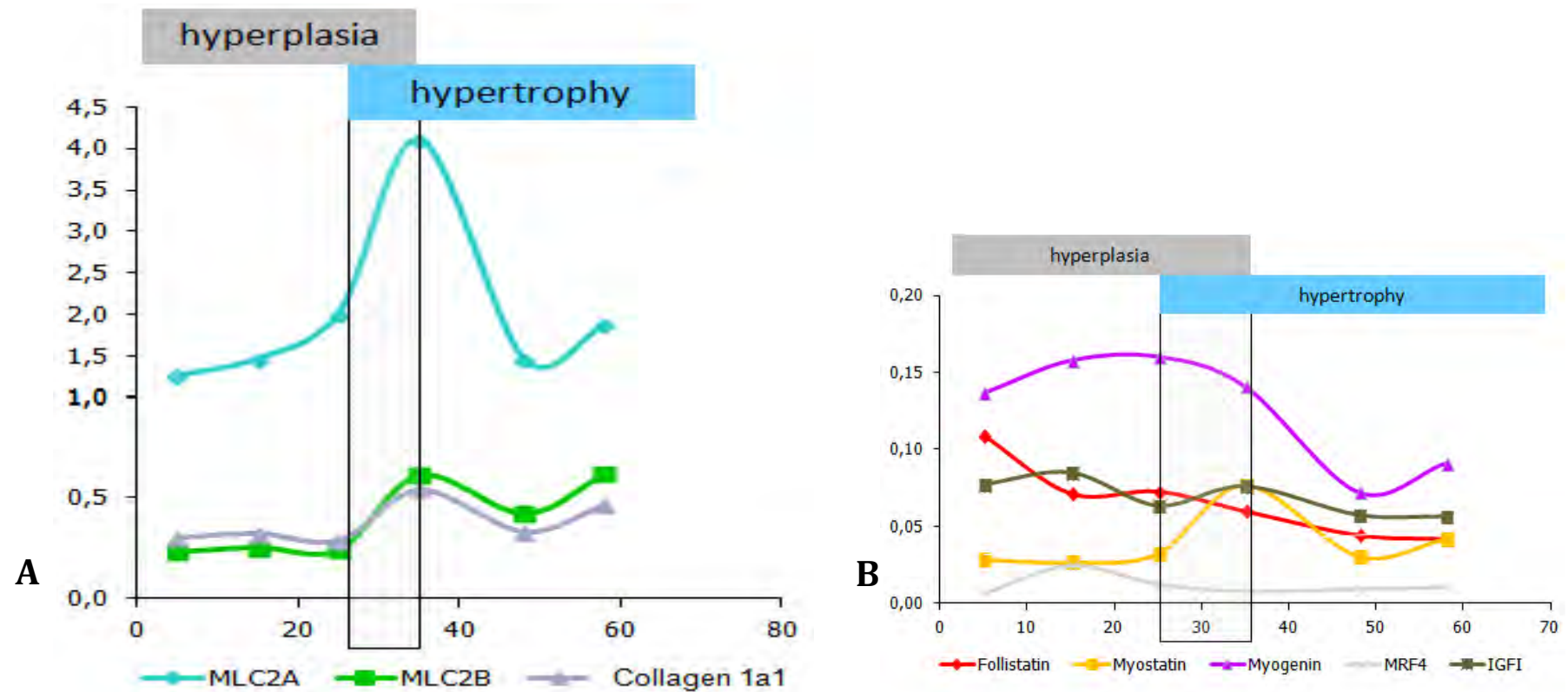

**Figure 3:** Expression patterns of structural (A; MLC2A, MLC2B, Col1a1) and regulatory (B; FST, MSTN-1, myogenin, MRF4, IGFI) genes in developing gilthead sea bream larvae. Values are given as means of normalized arbitrary expression levels of 10 larvae.

Myogenin was highly expressed during hyperplasia and it was down-regulated after 35 dph when the activity of the apical germinal zones ceased and hypertrophy became the predominant growth mechanism ( $P < 0.001$ , Figure 3B). Expression of MRF4 remained at very low levels throughout early development and a peak in its expression occurred at 15 dph and coincided with the establishment of apical germinal zones and the accumulation of newly-formed fibers ( $P = 0.02$ , Figure 3B). Myostatin 1 peaked transiently at 35 dph when the transition between hyperplasia and hypertrophy and MLC2A and MLC2B occurred (Figure 3A-B). Contrary to IGFI that exhibited steady expression during these early developmental stages, follistatin was most abundant on 5 dph and declined progressively as the development of muscle advanced ( $P \leq 0.001$ , Figure 3B).

**Table 3:** Spearman rank correlation coefficients between structural (shaded) genes, myogenic and regulatory factors in developing gilthead sea bream larvae. \* $P < 0.05$ ; \*\* $P < 0.01$ ; \*\*\* $P < 0.001$ .

	MLC2A-M	MLC2A-L	MLC2B	COL1a	MRF4	MYOG	MSTN	FST	IGF12
MLC2A-S	0.741***	0.807***	0.482***	0.457***	-	0.294***	0.589***	-	0.270***
MLC2A-M		0.785***	0.631***	0.402**	-	-	0.473***	-	-
MLC2A-L	-		0.460***	0.356**	-	0.287***	0.567***	-	0.356**
MLC2B	-	-		0.605***	-	-0.366**	0.643***	0.502***	-
COL1a					0.376**	-	0.735***	-0.288*	0.292*
MRF4	-	-	-			-	-0.289*	-	-0.300*
MYOG	-	-	-	-	-		-	0.632***	0.435**
MSTN	-	-	-			-		-0.276*	0.510***
FST	-	-	-		-	-	-		-



All three alternative transcripts of MLC2A were detected during development and exhibited similar expression patterns peaking on 35 dph (Figure 4). MLC2A-S was by far the most abundant transcript ( $P=0.003$ ) and corresponded to 41-52 % of the total MLC2A transcripts followed by MLC2A-L (Figure 4). MLC2A-M was generally the least abundant transcript but was the most variable and corresponded to 8-34 % of the total MLC2A transcripts detected at different times during development. The expression of all three MLC2A transcripts was significantly and positively correlated as indicated by Spearman rank correlation ( $P<0.05$ , Table 3).

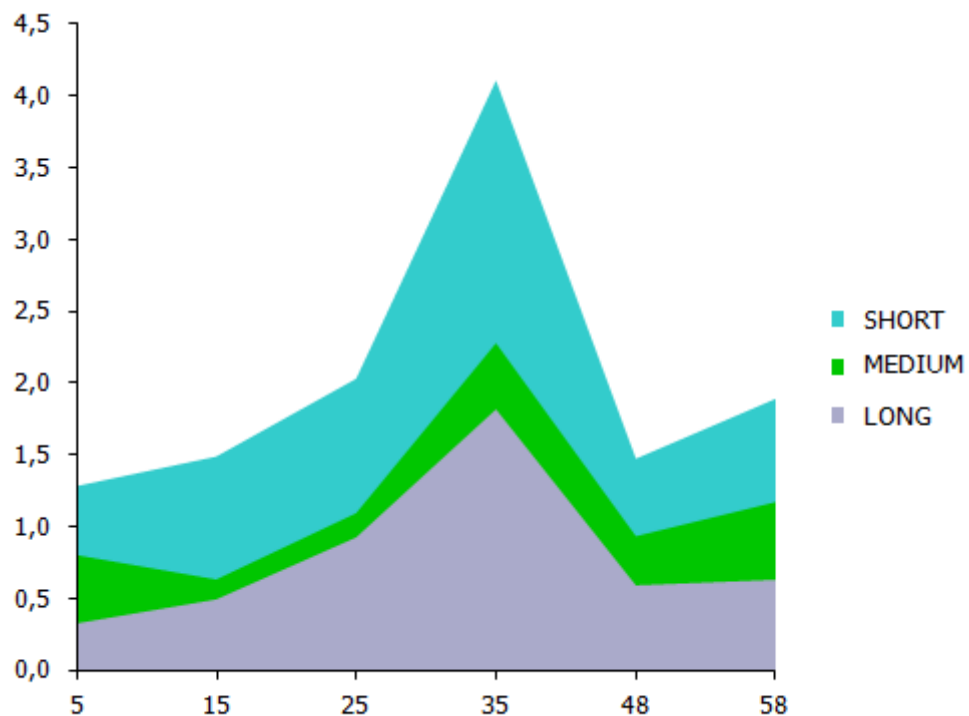

**Figure 4:** Expression patterns of the three alternative transcripts of MLC2A in developing gilthead sea bream larvae. Values are given as means of normalized arbitrary expression levels of 10 larvae.

#### *4.3.4 Hierarchical gene clustering*

Hierarchical clustering was performed on mean expression levels of the ten genes studied. Genes were clustered on the basis of the similarity of their expression during gilthead sea bream larval development. Two major clusters were formed: cluster I contained all the structural genes (MLC2A, MLC2B, COL1a) and cluster II all the regulatory factors (MYOG, IGFI, FST, MRF4) with the exception of myostatin that fell into cluster I (Figure 5). The expression of genes in both clusters changed at the transition from predominantly hyperplastic to hypertrophic growth (35 dph); genes in cluster I were up-regulated in hypertrophy whereas genes in cluster II were down-regulated (Figure 5).

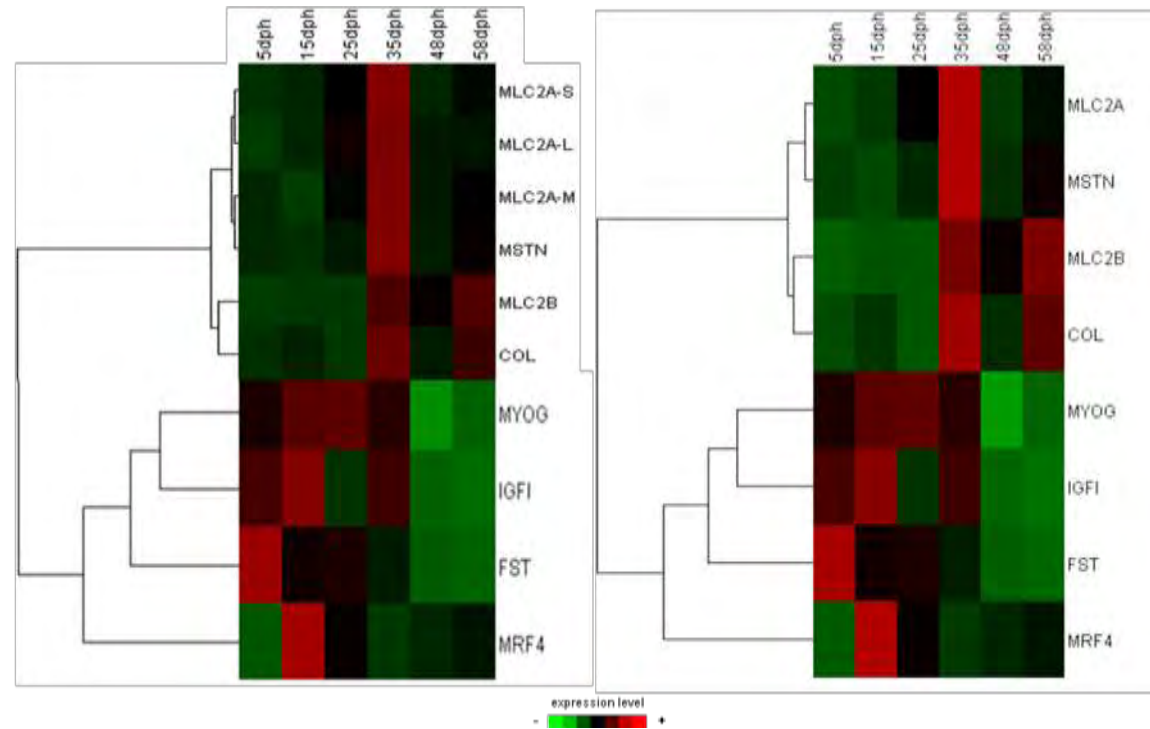

**Figure 5:** Hierarchical clustering of the eight target genes during gilthead sea bream larval development. Gene clustering is based on transcript expression levels. The different ages of gilthead sea bream larvae (days post hatch; dph) that were used in the analysis are represented in columns whereas the different genes are represented in rows. Relative abundance of each transcript across different ages is represented by a colour scale: red and green indicate an increase and a decrease in mean gene expression level compared with an initial level of expression from 5 to 58 dph respectively, black indicates no change. **A**, the three alternative transcripts of MLC2 are presented separately; **B**, the sum expression of MLC2A transcripts was used. *MLC2A-S*: short MLC2A transcript, *MLC2A-M*: medium MLC2A transcript, *MLC2A-L*: long MLC2A transcript, *MLC2B*: MLC2 isoform B, *MYOG*: myogenin, *MSTN*: myostatin, *COL*: collagen 1a1, *FST*: follistatin, *IGFI*: insulin-like growth factor I, *MRF4*: myogenic regulatory factor 4.

## **4.4 Discussion**

### *4.4.1 Muscle cellularity*

Muscle cellularity reflects the collective activity of different growth mechanisms that result in accumulation of structural muscle proteins. Total muscle fiber number has been tightly linked to the final size fish attained and their growth potential in the wild and under farmed conditions (Weatherley et al. 1988; Pitkänen et al. 2001; Johnston et al. 2004).

Early developmental stages in fish are characterized by an alteration of mechanisms that lead to new muscle fiber formation; embryonic muscle development is succeeded by stratified hyperplasia while mosaic hyperplasia takes over post-metamorphosis (Rowlerson & Veggetti 2001 and references therein). The period from hatch to metamorphosis is marked by dramatic hyperplastic growth with the formation of new fibers happening in the apical – dorsal and ventral – germinal zones. This pattern of development has previously been described in gilthead sea bream (Ramírez-Zarzosa et al. 1995; Rowlerson et al. 1995) and was confirmed in the present study. Transverse sections of muscle epaxial quadrants at 15, 25 and 35 days post hatch revealed the characteristic W-shape arrangement of myomeres divided by myosepta. Myotomal muscle consisted of a superficial red muscle layer and deep white muscle fibers underneath. The cellularity of a white muscle epaxial quadrant differed significantly between these early stages. Hyperplasia was the predominant mechanism of muscle growth up to 25 dph and muscle fibers continue forming up to 35 dph (Figure 1A). However, between 25 and 35 dph hypertrophic growth was initiated marking a transition state. A pause in fiber formation was recorded between 35 and 60 dph when hypertrophy was the main mechanism of muscle growth. Rowlerson and colleagues (1995) also failed to report a significant increase in TNWF between 46 and 60 dph. In the latter work, no significant increase in mean fiber area was reported up to 46 dph contrary to the present findings indicating high hypertrophic activity from 25 dph onwards. Furthermore, the percentage of fibers with diameter <5 μm reported on 15 and 25 dph was much lower than in the present study. Given that the same approach to fiber analysis was used in both studies it is possible that the discrepancies between the two studies reflect differences in genetic background and rearing temperature (15-18 °C vs 19 °C constant). As previously reported, the pace of both hyperplastic and hypertrophic growth and thus muscle

cellularity was highly affected by temperature during early larval rearing (Alami et al. 2000; Johnston et al. 1995, 2000; Alami-Durante et al. 2006).

Although total fiber number has been a strong marker of growth, in these early stages growth rate was not directly correlated to muscle fiber number throughout development and larval axial growth was linear even when no more fibers were formed. However, mean area, perimeter and diameter increased in a steady linear manner up to metamorphosis supporting axial growth indicating that a combination of parameters of muscle cellularity are required to assess growth at early stages.

35 dph most likely represented an intermediate stage in gilthead sea bream development as muscle growth was attributed to both hypertrophic and hyperplastic mechanisms. Small diameter white fibers (<5  $\mu\text{m}$ ), indicative of new fiber formation (Rowlerson et al. 1995), constituted a germinal zone in the most apical myotome edge. New white muscle fiber formation was more pronounced in 15 and 25 dph gilthead sea bream larvae. After metamorphosis (48 and 58 dph) the germinal zone expanded to the deeper white muscle surface and mosaic hyperplasia occurred as new small diameter fibers arose between the mature white fibers; a characteristic feature of species that attain a large final size (Rowlerson & Veggetti, 2001). As reported in other fish species, growth in gilthead sea bream larvae after 35 dph was achieved by an increase in muscle fiber size (Weatherley et al. 1988; Johnston et al. 2003). Many authors (Weatherley et al. 1988; Johnston et al. 2003, 2008) have proposed that new fiber input proceeds until fish achieve 40-45 % of their definite total length. However, the current experimental design did not allow for such an observation in gilthead sea bream.

#### *4.4.2 Gene expression and muscle development*

Larva to adult transition appeared well orchestrated in white muscle of gilthead sea bream larvae at the molecular level. The results of the present study suggest that the two isoforms of myosin light chain 2 may be under differential developmental regulation. Pre-metamorphic MLC2A increasing expression together with new fiber formation makes MLC2A a potential candidate marker of new fibers, while MLC2B that has a significant increase in expression at the onset of metamorphosis provides support to the idea that MLC2B may be the predominant adult isoform in gilthead bream muscle. Given that MLC2 is a sarcomeric protein, the correlation of its expression levels to muscle growth is largely expected but the significance

of the association of the two isoforms with either hyperplasia or hypertrophy requires further investigation. MLC2A protein derives from three different transcripts generated by alternative polyadenylation signal selection (Sarropoulou et al. 2005). All three transcripts encode exactly the same protein and differ only in the length of their 3' UTRs, making them subject to alternative regulation (Chapter 3). In agreement with previous results (Chapter 2) MLC2A-S was by far the most abundant transcript during development suggesting that this might be the "working" transcript utilized at the cellular level. MLC2-L was the second most abundant transcript followed very closely by MLC2A-M. However, unlike our previous results MLC2A-S constituted a lower percentage of the total MLC2A transcripts at all stages studied. This discrepancy might be indicative of the complex regulation that results from the regulatory elements residing in 3' UTRs (Chapter 3). An insight into the differential regulation imposed on the three transcripts was also offered by the hierarchical cluster analysis; although MLC2-M clustered closely with the other two transcripts, it clustered the closest with MSTN1 (Figure 5A).

Muscle differentiation is a complex process that requires the combined action of certain transcription factors, the myogenic regulatory factors (MRFs), the expression of which is finely regulated both temporally and spatially (Ferri et al. 2009). The transcription, subcellular localization and protein half-life of MyoD, Myf5, myogenin and MRF4 appear to be tightly regulated to ensure myogenic determination, proliferation and myotube differentiation (Zhang et al. 1995; Kassam-Duchossoy et al. 2004; Ishibashi et al. 2005; Patterson et al. 2008; Ferri et al. 2009). Myogenin and MRF4 are factors that govern middle and terminal differentiation phases and orchestrate the expression of the muscle-specific genes including those encoding for the contractile proteins (Sánchez and Robbins 1994; Blais et al. 2005). In the present study, myogenin was expressed at highest levels during the formation of new fibers up to 35 dph and then declined together with MLC2A (Figure 3B). The results of the present study are in agreement with our previous study of developing gilthead sea bream larvae, primary muscle cell cultures and the results from studies of other organisms that indicate myogenin is an important regulator of muscle differentiation (Chapter 2; Dedieu et al. 2002; Cao et al. 2006; Ferri et al. 2009). Cumulative data point to its crucial role in terminal differentiation and the control of synthesis of the proteins of the contractile apparatus (Blais et al. 2005). Studies in C2C12 cells showed that myogenin is already expressed in undifferentiated cells, where it is restricted in the cytoplasm. It is only after the induction of differentiation that it is translocated into the nucleus to exert its action (Ferri et al. 2009). This pattern is consistent with its high

expression levels as early as 5 dph in gilthead sea bream when proliferation of small fibers prevailed. The significant positive correlation between the expression of myogenin and transcripts of MLC2A both of which are elevated during the phase of intensive formation of new fibers, reinforces the notion that they may be good candidate markers of hyperplasia. The small rise in MRF4 expression at 15 dph is indicative of its role in determination rather than differentiation and this is in line with the contemporary hypothesis that MyoD, Myf5 and MRF4 define muscle identity and that muscle differentiation is driven by MyoD, myogenin and MRF4 (Kassar-Duchossoy et al. 2004; Ferri et al. 2009). Nonetheless, the relative expression levels of the myogenic factors MRF4 and MyoD followed the patterns reported in C2C12 cells with myogenin being the most abundantly expressed myogenic factor (Ferri et al. 2009).

Myostatin is considered to be an inhibitor of proliferating myoblasts and a major negative regulator of fiber number (Ostbye et al 2001). Two MSTN paralogues have been identified in gilthead sea bream, MSTN-1 and MSTN-2 (Maccatrozzo et al. 2001; Nadjar-Boger & Funkenstein 2011). MSTN-1 is predominantly expressed in muscle and MSTN-1 gene polymorphism has been associated with growth traits (Sanchez-Ramos et al. 2012). Consistent with its growth inhibitory role, MSTN-1 expression was previously reported to be low in gilthead sea bream during the early developmental stages (1 to 44 dph) (Maccatrozzo et al 2001). In the current study however, MSTN-1 had the same expression pattern as MLC2A and transiently peaked on 35 dph (Figure 3B), pointing to a possible role on regulating the shift from hypertrophy to hyperplasia. A similar pattern has been reported in C2C12 cells with MSTN being detected in the myotubes but not in the myoblasts (Artaza et al. 2002) and up-regulation was initiated with nuclei accretion. During the hypertrophic stage MSTN protein was localized within the nuclei suggesting it may have a role as a transcription factor. Stage-specific MSTN expression overlapped with strong up-regulation of the major myosin heavy chain isoform MHC-II and to a lesser degree with MHC-I (Artaza et al. 2002). A similar phenomenon was observed from hierarchical gene clustering, in the present study as MSTN-1 did not group with the other regulatory genes, but it fell within the cluster of structural genes (Figure 5, Table 3). These data combined together point to a versatile regulatory action of the myostatin molecule during ontogeny that is worth revisiting.

Myostatin action is antagonized by follistatin in mammals and chicks and several observations have connected FST to positive muscle growth (Matzuk et al. 1995; Lee & McPherron 2001; Amthor et al. 2004). A similar antagonistic myostatin-follistatin interaction

was shown in gilthead sea bream with the use of recombinant saFST over saMSTN activity in a reporter gene assay (Funkenstein & Rebhan 2007; Funkenstein et al. 2009). In adult gilthead sea bream tissues follistatin is expressed at higher levels than MSTN and its expression is detectable before hatch, 15-16 hours post fertilization (Funkenstein et al. 2009). The expression patterns of FST and MSTN in the present study are in agreement with the results of the previous study with larvae up to 10 dph (Funkenstein et al. 2009). We extended the temporal observations to show that FST expression declined slowly up to metamorphosis and it was significantly and negatively correlated with MSTN-1 expression, yet positively correlated with myogenin expression (Table 3). Thus, FST appeared to negatively interact with MSTN-1 *in vivo* and it was associated more with the hyperplastic than the hypertrophic phase.

IGF-1 is a molecule with a pleiotropic action in gilthead sea bream that appears to mediate the effects of growth hormone in seasonal growth, to have a pivotal role in compensatory growth following starvation, to induce osteoblast and myoblast proliferation in primary cell cultures and to increase glucose and amino acid uptake in cultured myoblasts through both MAPK and PI3K-Akt signal transduction pathways (Mingarro et al. 2002; Montserrat et al. 2007; Capilla et al. 2011; Rius-Francino et al. 2011; Montserrat et al. 2012). IGF-1 transcripts were detected in unfertilized gilthead sea bream eggs and its later expression appeared to be tissue- and age dependent with skeletal muscle displaying high immunoreactivity (Perrot et al. 1999). In Atlantic salmon increased IGF-1 expression marked the transition from zero to fast growth and was followed by increased expression of myosin genes including MLC2 (Bower et al. 2008). Three alternatively spliced transcripts of IGF-1 have been isolated in gilthead sea bream (Tiago et al. 2008) and each has a distinct expression pattern during development. IGF-1c is the dominant transcript and increased from hatch to metamorphosis (Tiago et al. 2008). The primers used in the present study were designed to amplify all three IGF-1 transcripts collectively. Nevertheless, total IGF-1 transcripts in the present study failed to exhibit a continuous increase as it was demonstrated by Fernández et al. (2011) for the same species and developmental stages. Instead, IGF-1 levels remained stable throughout the period of study and they did not display any fluctuation at the transition between hyperplasia and hypertrophy, in agreement with the findings of Perrot et al. (1999), who observed stable low IGF-1 expression levels throughout early development in gilthead sea bream. However, IGF-1 expression was significantly and positively correlated with the expression of muscle-specific structural genes and the expression of myogenin that manifested involvement in terminal differentiation and hypertrophic growth.



Collagen1a1, apart from MLC2 forms was the other structural gene studied and represents more than 90 % of the collagen in extracellular matrix proteins. Col 1a1 expression remained low at the early stages to rise after 35 dph. The expression pattern observed was consistent with earlier results in the same gilthead sea bream, in which col 1a1 expression was low up to 29 dph and was significantly up-regulated between 29-37 dph (Fernández et al. 2011). A similar expression pattern was also observed during European sea bass development where col 1a1 expression was positively correlated to bone development (Darias et al. 2008) suggesting col 1a1 high biological importance in providing mechanical support in both the growing skeleton and the increasing muscle fiber organization.

#### **4.5 Concluding remarks**

The development of white musculature in gilthead sea bream larvae demonstrated distinct hyperplastic and hypertrophic phases as evident by changes in muscle cellularity. The expression patterns of MLC2 marked the two phases in an isoform-specific manner; MLC2A marked new fiber formation in the germinal zones and appeared early in development; MLC2B was up-regulated only at hypertrophy in a later developmental stage. Myogenin and MSTN-1 were regulatory factors that were strongly correlated to changes in cellularity and also MLC2 expression profiles. Future studies will be aimed at understanding the interaction between regulatory factors and MLC isoforms.

*Chapter Σφάλμα! Χρησιμοποιήστε την καρτέλα "Κεντρική σελίδα", για να εφαρμόσετε το  
Heading 1 στο κείμενο που θέλετε να εμφανίζεται εδώ.*

---

## ***Chapter 5***

*Chapter Σφάλμα! Χρησιμοποιήστε την καρτέλα "Κεντρική σελίδα", για να εφαρμόσετε το  
Heading 1 στο κείμενο που θέλετε να εμφανίζεται εδώ.*

---

## **Chapter 5**

### **Can myosin light chain 2 isoforms serve as growth markers?**

#### **5.1 Introduction**

The ongoing demand for fish for human consumption has led the aquaculture sector to seek alternative hatchery techniques that improve juvenile quality and growth potential. Finfish larviculture has to cover a wide variety of species' habitats and prey preferences in order to mimic the natural environment and optimize the biological capacity (survival and growth) of juveniles. To that direction new aquaculture systems have emerged the last decade differing in the degree of intensiveness and water quality (Shields 2001; Hussenot et al. 2003). Similarly, hatchery systems encompass various techniques that differ in larvae stocking density (intensive, extensive and mesocosm systems), prey source and availability (phytoplankton or zooplankton, live or inert food, endogenous or exogenous prey supply), tank enclosures as well as quality of water and hydroid system (clean water, green water, pseudo-green water, open or closed water circuit). Intensive techniques that run expensive, indoor infrastructures with fully controlled environmental conditions and require highly specialized know-how have become the most common practice. Intensive systems can accommodate 80-100 larvae L<sup>-1</sup> as opposed to the semi-intensive mesocosm systems where larvae density is 2-10 larvae L<sup>-1</sup> (Divanach & Kentouri 2000). Mesocosm technology is applied in indoor or semi-outdoor facilities in which handling is minimal and stress is significantly reduced. Mesocosm systems present partial prey autarky due to the integrated plankton community that inhabits the tanks prior to larvae introduction. The more natural environment created in the mesocosm systems facilitates the production of fish with high resemblance to wild individuals and low incidence of deformities compared with the intensively-reared counterparts (Divanach & Kentouri 2000; Shields 2001; Zouiten et al. 2011; Khemis et al. 2012). In industrial scale certain marine species (gilthead sea bream, European sea bass, sole, turbot, flounder, red drum, cobia) are successfully reared in the intensive technology, in sharp contrast to mesocosm technology which accommodates many more species (Divanach & Kentouri 2000; Schwarz et al. 2009).

A common problem in hatchery practice is the heterogeneous body growth in larvae that results in alternate growth trajectories, juvenile size disparity and finally production loss

due to limited survival. Size variability in fish deriving from the same egg-batch is a common shortcoming in the aquaculture industry of many fish species due to its effect on survival (Huntingford et al. 1990; Stefánsson et al. 2000; Smith & Fuiman 2003; Saoud et al. 2007). A common practice to ameliorate growth rate discrepancies and achieve maximal biomass gain is size-grading at regular time intervals (Wallat et al. 2005; Ghanawi & Saud 2010). The rationale behind this is to avoid the establishment of dominant social interactions of large individuals to subordinates as a means to enhance uniform food distribution in the tank while reducing cannibalism indices. However, the effect of size-grading is not uniform across fish species. Rearing effectiveness after size-grading was not improved in Arctic charr (*Salvelinus alpine*, Wallace & Kolbeinshavn 1988; Baardvik & Jobling 1990), European eel (*Anguilla Anguilla*, Kamstra 1993), channel catfish (*Ictalurus punctatus*, Carmichael 1994), turbot (*Scophthalmus maximus*, Sunde et al. 1998), silver perch (*Bidyranus bidyanus*, Barki et al. 2000), cod (*Gadus morhua*, Lambert & Dutil 2001), pikeperch (*Sander lucioperca*, Zakęs et al. 2004), Dover sole (*Solea solea*, Overton et al. 2010), whereas higher growth rates and survival were observed in Atlantic salmon (*Salmo salar*, Gunnes 1976), gilthead sea bream (*Sparus aurata*, Popper et al. 1992) and Nile tilapia (*Oreochromis niloticus*, Brzeski & Doyle 1995). Molecular tools with capacity to predict growth performance at early stages and allow for informed decisions on handling of individuals with undesired traits could be valuable in the everyday practice as well as in marker-assisted selection schemes aiming at optimizing growth performance in a uniform manner.

Hatchery rearing systems and handling manipulations are expected to exert a significant impact on muscle quality, not yet elucidated. Axial skeletal muscle represents 45-65 % of fish body mass (Alami-Durante 1990; Valente et al. 1999) and is composed of white muscle fibers by 90 % (Alami-Durante et al. 2010a). White muscle development in larvae and somatic growth in juveniles rely on recruitment of newly formed fibers (hyperplasia) along with the progressive hypertrophic growth of existing white muscle fibers (Stellabotte & Devoto 2007; Rescan 2008; Johnston et al. 2011). In gilthead sea bream the same mechanisms of muscle development and growth have been observed (Rowlerson et al. 1995; Chapter 4). In Chapter 4 the hyperplastic and hypertrophic mechanisms of muscle growth were tightly linked to the expression of the isoforms of skeletal myosin light chain 2 (MLC2). *mlc2a* predominated the early pre-metamorphic larval stages marking the formation of new muscle fibers, while *mlc2a* gene expression gradually escalated from very low pre-metamorphic levels to a 10-fold higher expression compared with *mlc2a* post metamorphosis when hypertrophy prevailed.

Moreover, both *mlc2* isoforms were significantly affected by growth hormone administration, yet in a differential manner (Chapter 2).

In the present study, the validity of *mlc2* isoform expression as markers of muscle development and growth was investigated. Body growth measured as axial growth was used for comparison with *mlc2* gene expression. Two sets of experiments were designed based on common farming practices in collaboration with commercial farming facilities; a) comparison of intensive vs mesocosm technology and b) the effect of size-grading of juvenile gilthead sea bream produced under common hatchery practice with sorters of increasing diameter on juvenile gilthead sea bream growth and *mlc2* isoform expression. The results offer substantial links between *mlc2* expression and growth disparity and possible applications are discussed.

## 5.2 Materials & Methods

### 5.2.1 Experiment 1: Intensive vs mesocosm larvae rearing

Gilthead sea bream larvae emerged from the same egg-batch were obtained from a natural spawning population in the Hellenic Center for Marine Research (HCMR, Iraklion, Crete, Greece). Rearing procedures were performed in two different hatchery techniques, i.e. the intensive treatment and the mesocosm treatment.

*Mesocosm.* Circular flatbottomed 40 m<sup>3</sup> tanks with a water depth of about 2 m were initially stocked with approximately 3–4 yolk-sac gilthead sea bream larvae L<sup>-1</sup> at the facilities of the Hellenic Center for Marine Research, Heraklion, Greece. *Chlorella minutissima* was added prior to first feeding and until the end of the period of feeding with rotifers (4–25 days post hatch; dph). Enriched *Artemia metanauplii* were added from 14 up to 50 dph, whereas artificial diet was added after 25 dph. Rotifers were enriched by overnight incubation in Protein DHA Selco (Inve A/S, Belgium) and *Artemia metanauplii* were enriched by overnight incubation in Easy DHA Selco (Inve A/S, Belgium). Prey item concentration was kept to a minimum of 2–3 rotifers mL<sup>-1</sup> and 0.2–0.3 metanauplii mL<sup>-1</sup>. A continuous flow was maintained throughout the rearing period (20 % of tank volume/day renewal at the outset, and increasing thereafter). Water temperature was kept at 19.6 °C. Rearing in mesocosms continued until 50 dph, when they were moved to rectangular 5 m<sup>3</sup> tanks.

*Intensive.* During the first rearing phase, two cylindroconical 500 L tanks were used supported by a 1 m<sup>3</sup> biofilter unit. Each tank was stocked to a density of 100 yolk-sac gilthead sea bream larvae L<sup>-1</sup>. An air-lift pump inside each unit supplied a continuous movement of water even when the water supply from the biofilter unit was very low. The larvae were fed rotifers (4–30 dph), *Artemia* enriched metanauplii (24–50 dph), whereas artificial diet was added after 30 dph. Live food was enriched as described above in the protocol for mesocosm units. The microalgae *Chlorella minutissima* was added during the period of feeding with rotifers. On 55 dph, about 5,000 fish were transferred to rectangular 5 m<sup>3</sup> tanks.

Total length was measured in 5, 6, 9, 11, 12, 13, 16, 18, 24, 30, 37, 44, 51 dph larvae using a microscope ocular ruler. For the gene expression analysis samples were collected on 4,

15, 25, 45 and 81 dph. Larvae were anaesthetized by 2-phenoxyethanol (1:5000, Sigma) and maintained in *RNA-later* (Sigma) at -20 °C until further use.

### *5.2.2 Experiment 2: Size-grading*

This experiment was conducted in a local hatchery, Dias Aquaculture SA (Maliakos Gulf, Greece), according to standard practices employed in the hatchery. Two broodstocks (parental contribution of 66 and 166 individuals, respectively) of gilthead sea bream were used. Larvae derived from eggs laid of a single day were reared in a 500 L indoor tank containing filtered sea water. Renewal rate increased from 7.2 to 27.0 % per day as larvae grew in size. Larvae were kept under a 24-hr light regime up to 25 dph to switch to 16:8 LD afterwards. Salinity, mean water temperature and oxygen concentration ranged at 27-30 ‰, 18.0-20.5 °C and  $7 \pm 2$  mg L<sup>-1</sup> respectively. Larvae were fed in excess twice a day with rotifers up to 23 dph and newly hatched *Artemia nauplii* were co-fed from 13- 25 dph during the nursing period. Dry commercial diet was introduced on 20 dph.

On 55 dph gilthead sea bream siblings were size-graded using 1.5 mm sorter and were allocated in two tanks (sorting S1, *a* and *b* groups, Figure 1). Each one of the two groups was additionally separated in another two groups with a 3.5 mm sorter (sorting S2). Groups *aa* and *ab* groups were created from the sorting of group *a* on 90 dph, whereas group *b* was sorted two days later (92 dph) to give groups *ba* and *bb*. The final sorting (S3) was performed with a 5 mm sorter to divide each group in two more groups; 104 dph *aa* group in *aaa* and *aab* groups, 111 dph *ab* group in *aba* and *abb* groups, 111 dph *ba* group in *baa* and *bab* groups, and 117 dph *bb* group in *bba* and *bbb* groups (Figure 1). The experiment lasted 62 days in total. At each time point total length was measured from 20-50 individuals per group. The mean fresh body weight of each sorted group was recorded by the hatchery staff as the mean of 15 individuals.



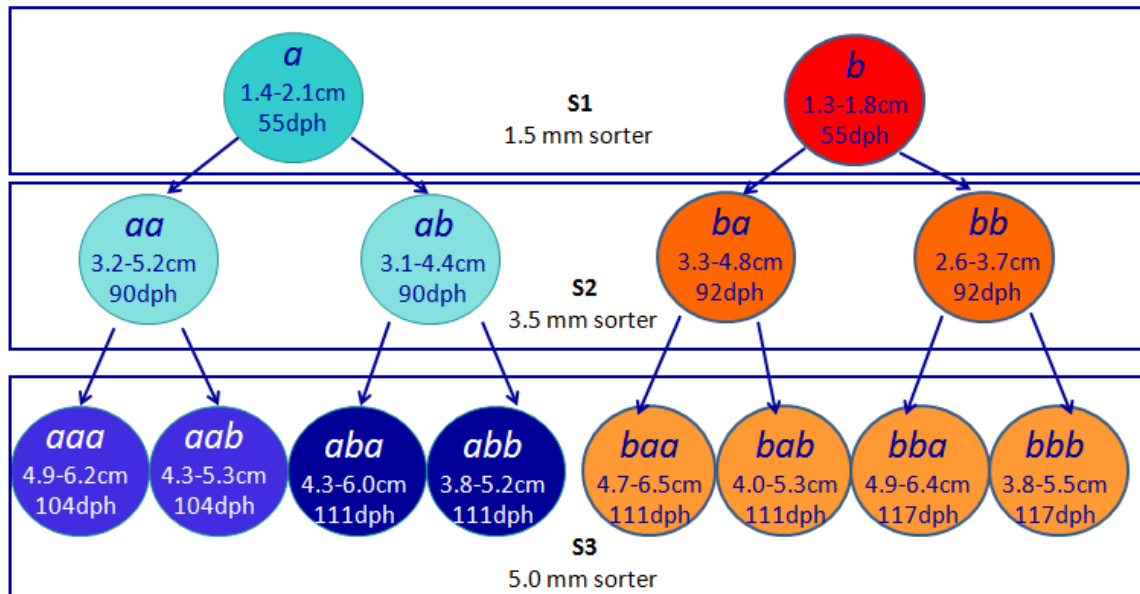

**Figure 1:** Graphical scheme of the three-stage size-grading procedure. The range of total length and the day of sorting are given for each group created: *a*, *b*, *aa*, *ab*, *ba*, *bb*, *aaa*, *aab*, *aba*, *abb*, *baa*, *bab*, *bba*, *bbb*. S1, sorting 1; S2, sorting 2; S3, sorting 3.

### 5.2.3 Gene expression analysis

In experiment 1, total RNA of 9 individuals was prepared from whole gilthead sea bream larvae of 4, 15, 25 dph whereas in 45 and 81 dph-old individuals white muscle was dissected for RNA extraction. Similarly, in experiment 2, total RNA was extracted from 9 individuals per group from the caudal part of the body. In both experiments RNA extraction was performed using TRI Reagent (Sigma) according to manufacturer's instructions. DNase treatment of total RNA to remove traces of genomic DNA was performed with *DNA-free* (Ambion) and RNA was stored in -80 °C. cDNA synthesis was carried out simultaneously for all samples to ensure the same reaction efficiency. 1 µg of total RNA was reverse transcribed using 200 U µL<sup>-1</sup> SuperScript II Reverse transcriptase (Invitrogen), 3 µg random primers (Invitrogen) and 40 U µl<sup>-1</sup> recombinant RNaseOUT Ribonuclease Inhibitor (Invitrogen) in total volume of 27 µl. The levels of *mlc2a* and *mlc2b* transcripts were measured (Table 1) by real-time PCR (MXPro 2000, Stratagene) in duplicate using KAPA SYBR FAST qPCR (2x) (KAPA Biosystems). All reactions were set up using 150-300 nmol L<sup>-1</sup> of each primer and 0.17 µg µl<sup>-1</sup> cDNA (1:5 diluted) in a reaction volume of 20 µl. The real-time PCR (Q-PCR) protocol consisted of an initial denaturation step at 95 °C for 3 min, 40 cycles of amplification (each cycle was 30 sec at 95 °C, 1

min at 61 °C, 1 min at 72 °C), followed by the dissociation curve step (1 min at 95 °C, 30 sec at 55 °C, 30 sec at 95 °C) for the verification of a single product amplification. Efficiency curves were generated for each cDNA template by plotting CT values against the log<sub>10</sub> of six serial dilutions of a mixed cDNA pool created from all samples analysed. Real-time PCR efficiency (E) was calculated as  $E=10^{-1/\text{slope}}$  (Pfaffl et al. 2002) and varied between 93 %-101 %. The normalization factor for each experiment separately was calculated as the geometric mean of the two most stably expressed housekeeping genes (RPL13 and RPS18).

#### *5.2.4 Statistical approach*

##### *5.2.4.1 Experiment 1*

In order to determine intergroup differences in gene expression levels of the two isoforms of *mlc2* two way analysis of variance (ANOVA) was used with age and system (mesocosm versus/intensive) as cofactors. Real-time PCR results are expressed as means ± S.E.M. Data failed to fit Kolmogorov–Smirnov test for normality were analysed using a non-parametric Kruskal–Wallis ANOVA median test (Zar 1996). When F values indicate significance, post-hoc non-parametric Tukey’s honestly significant difference multiple range test (Tukey HSD) was undertaken on individual means to determine the influence of age on *mlc2* gene expression and the influence of treatment within age group. For all statistical tests, level of significance was set at  $P<0.05$ . Data analysis was performed with the SigmaStat software (version 3.5; STATCON).

##### *5.2.4.2 Experiment 2*

In order to determine intergroup differences in gene expression levels of the two isoforms of *mlc2* one way analysis of variance (ANOVA) was used. Real-time PCR results are expressed as means ± S.E.M. Data failed to fit Kolmogorov–Smirnov test for normality were analysed using a non-parametric Kruskal–Wallis ANOVA median test (Zar 1996). When F values indicate significance, post-hoc non-parametric Dunn’s test was undertaken on individual means to determine the influence of size-grading on *mlc2* gene expression. For all statistical tests, level of significance was set at  $P<0.05$ . Data analysis was performed with the SigmaStat software

*Chapter Σφάλμα! Χρησιμοποιήστε την καρτέλα "Κεντρική σελίδα", για να εφαρμόσετε το  
Heading 1 στο κείμενο που θέλετε να εμφανίζεται εδώ.*

---

(version 3.5; STATCON). Spearman's rank correlation was run in order to assess the statistical dependence between two variables (Zar 1996).

**Table 1:** Genes, accession numbers, and primers used for real-time PCR gene expression analysis.

<b>Gene</b>	<b>Accession number</b>	<b>Forward primer</b>	<b>Reverse primer</b>	<b>Product size</b>
<b>RPL13a</b>	CV133427	TCTGGAGGACTGTCAGGGGCATGC	AGACGCACAATCTTAAGAGCAG	147
<b>RPS18</b>	AM490061	AGGGTGTGGCAGACGTTAC	GAGGACCTGGCTGTATTTGC	196
<b>MLC2A</b>	AF150904	GCCCCATCAACTTCACCGTCTTT	GGTTGGTCATCTCCTCAGCGG	188
<b>MLC2B</b>	FG618631	TCCCTTTGCTATTCTGCCTTC	AAATCAGCCCTATTCCCCATA	180

## 5.3 Results

### 5.3.1 Experiment 1

In both mesocosm and intensive rearing systems total length was recorded from 5 dph up to 51 dph. Larvae raised in the mesocosm system grew faster and reached a greater total length significantly different from 13 dph onwards ( $P < 0.05$ , Figure 2).

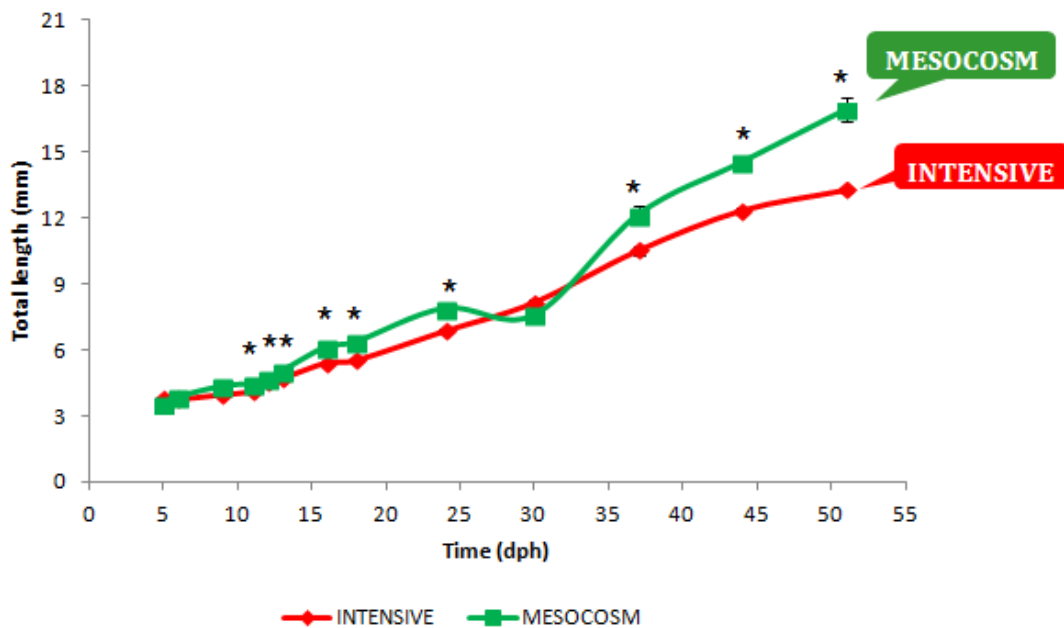

**Figure 2:** Evolution of total length (mean values  $\pm$  SEM) in gilthead sea bream larvae reared in intensive (red) and mesocosm (green) systems up to 55 days post hatch. Significant statistical differences between intensive and mesocosm at each time point are denoted with an asterisk ( $P < 0.05$ ).

Expression of the two isoforms of *mhc2* exhibited the same trend in the intensive and the mesocosm system. *mhc2a* expression increased gradually from 4 dph onwards and peaked on 45 dph ( $P < 0.001$  for both systems, Figure 3A). In intensively-reared individuals *mhc2a* expression remained at high levels up to 81 dph in contrast to mesocosm-reared individuals that *mhc2a* expression significantly declined ( $P < 0.001$ , Figure 3A). The expression pattern of *mhc2b* was the same in both larviculture systems (Figure 3B). *mhc2b* remained at low levels in the pre-metamorphic stages, to rise steadily from 45 to 81 dph ( $P = 0.002$ , Figure 3B). The ratio of *mhc2a/mhc2b* expression exhibited differentiating patterns between intensive and mesocosm

systems (Figure 3C). In intensively-reared larvae it fluctuated for 25 dph and reached the highest value on 45 dph ( $P<0.001$ ) before declining to very low levels by 81 dph ( $P<0.001$ , Figure 3C). In contrast, in mesocosm-reared larvae *mlc2a/mlc2b* expression increased to peak on 25 dph ( $P<0.001$ ) and a gradual decline followed by 81 dph ( $P<0.001$ ). *mlc2a/mlc2b* expression was significantly different between larvae from the two rearing systems on 15, 25 and 45 dph ( $P<0.001$ ).

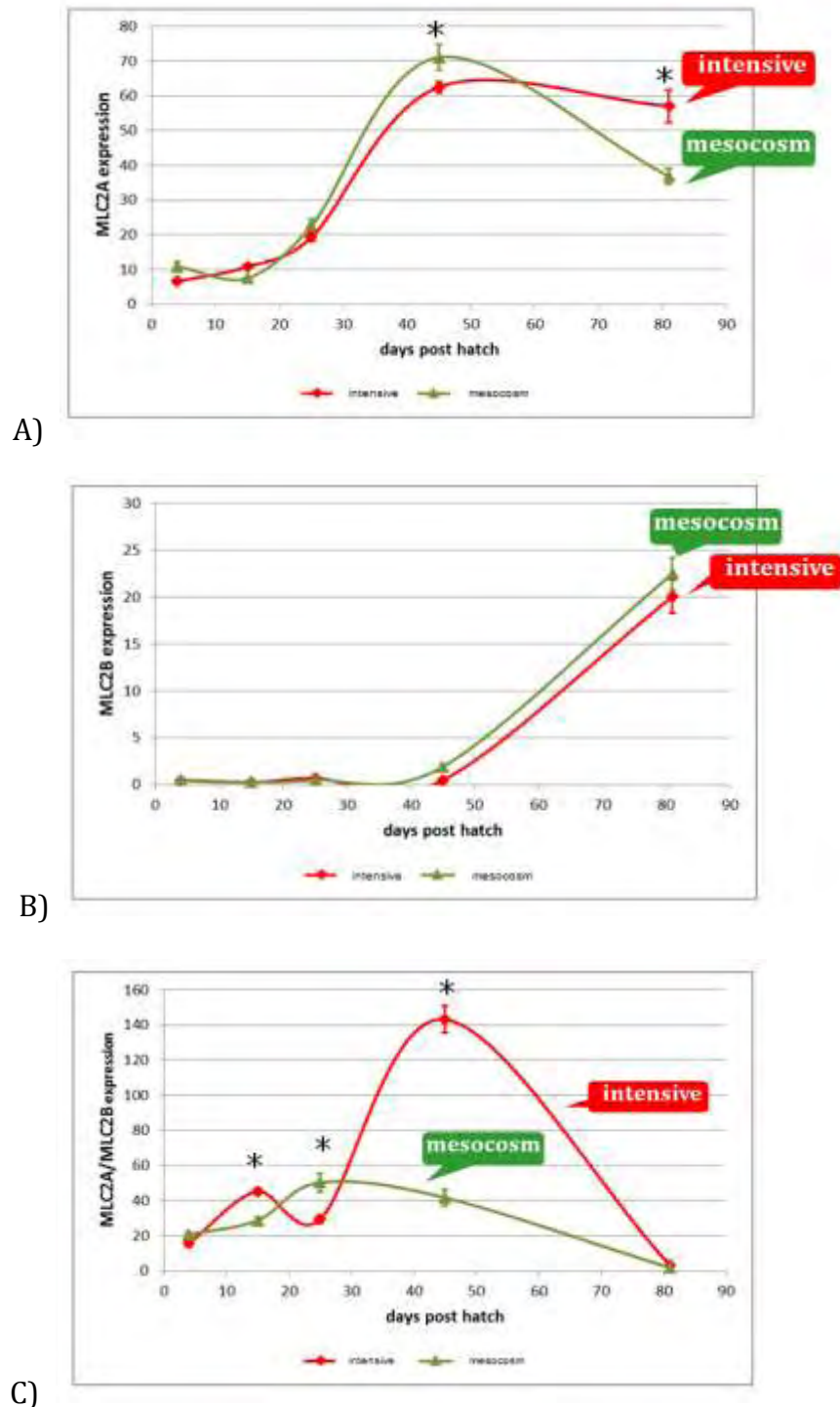

**Figure 3:** *mlc2a* (A), *mlc2b* (B) and *mlc2a/mlc2b* (C) expression levels in gilthead bream individuals reared in intensive or mesocosm system during hatchery stages. Values are means  $\pm$  SEM of 9-18 individuals. Significant statistical differences between intensive and mesocosm at each time point are denoted with an asterisk ( $P < 0.05$ ).

### 5.3.2 Experiment 2

Mean total length increased significantly over time ( $P < 0.05$ ) but remained at similar intergroup levels in each growth period (Table 2).

**Table 2:** Mean weight, mean total length  $\pm$  SEM and range of length in gilthead sea bream size-graded per growth period. Groups within each sorting sharing the same letters are not statistically different ( $P < 0.05$ ).

Group	Sorting No	Day of sorting	N	Mean weight (g)	Total length (cm)	Range of total length (cm)
<b>a</b>	S1	55	50	0.07	$1.78 \pm 0.0^a$	0.7
<b>b</b>	S1	55	50	0.03	$1.53 \pm 0.0^b$	0.5
<b>aa</b>	S2	90	20	0.90	$4.07 \pm 0.1^a$	2.0
<b>ab</b>	S2	90	20	0.44	$3.57 \pm 0.1^{b,c}$	1.3
<b>ba</b>	S2	92	20	0.85	$3.84 \pm 0.1^{a,c}$	1.5
<b>bb</b>	S2	92	20	0.39	$3.04 \pm 0.1^d$	1.1
<b>aaa</b>	S3	104	50	1.98	<b><math>5.35 \pm 0.0^{a,b,c}</math></b>	<b>1.3</b>
<b>aab</b>	S3	104	50	1.29	$4.82 \pm 0.0^d$	1.0
<b>aba</b>	S3	111	50	2.62	$5.24 \pm 0.1^b$	1.7
<b>abb</b>	S3	111	50	1.47	$4.52 \pm 0.0^d$	1.4
<b>baa</b>	S3	111	50	1.65	<b><math>5.58 \pm 0.1^{a,b}</math></b>	<b>1.8</b>
<b>bab</b>	S3	111	50	1.15	$4.83 \pm 0.0^d$	1.3
<b>bba</b>	S3	117	50	2.17	$5.54 \pm 0.0^b$	1.5
<b>bbb</b>	S3	117	50	1.09	$4.83 \pm 0.1^d$	1.7



Mean *mlc2a* expression (Figure 4) was not significantly different between the groups derived from S1 ( $P=0.204$ ) and S2 ( $P=0.110$ ). However, a highly significant difference was recorded between groups of S3 ( $P<0.0001$ ) with group *aab* exhibiting the highest expression (Figure 4). Although a decrease in average *mlc2a* expression was observed between S1 and S2, by S3 it had been restored to S1 levels.

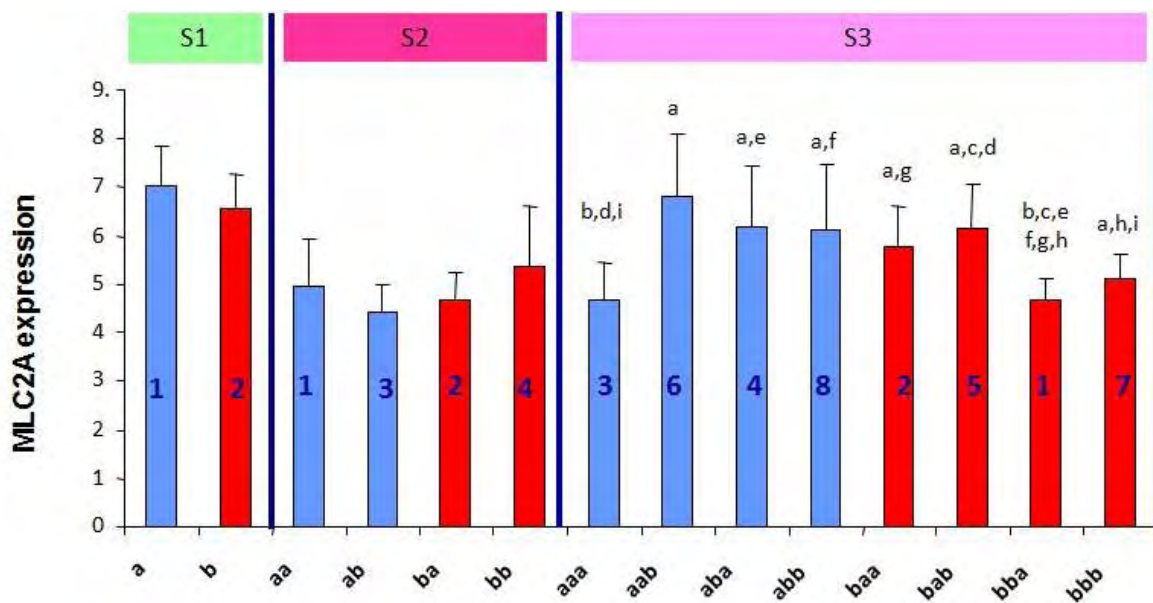

**Figure 4:** *mlc2a* expression levels (mean  $\pm$  SEM) in the groups of gilthead sea bream generated in three successive size-sortings (S1, S2, S3). Blue and red columns indicate the derivative groups of *a* and *b*, respectively. Groups within each sorting sharing the same letters are not statistically different ( $P<0.05$ ). Numbers within the columns indicate the comparative rating of group according to mean total length in each sorting.

Mean *mlc2b* expression significantly rose ( $P < 0.001$ ) from S1 to S2 and S3 (Figure 5). In S1 group *a* exhibited significantly higher expression ( $P < 0.0001$ ) than group *b*. Statistically significant differences in *mlc2b* expression were also observed between the groups created at S2 ( $P = 0.009$ ) and S3 ( $P = 0.0001$ ).

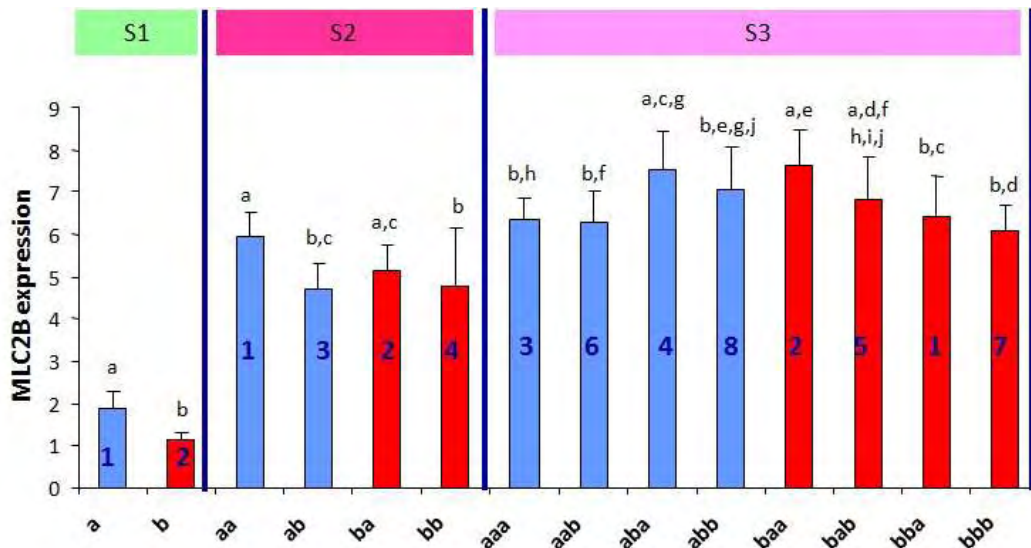

**Figure 5:** *mlc2b* expression levels (mean  $\pm$  SEM) in the groups of gilthead sea bream generated in three successive size-sortings (S1, S2, S3). Blue and red columns indicate the derivate groups of *a* and *b*, respectively. Groups within each sorting sharing the same letters are not statistically different ( $P < 0.05$ ). Numbers within the columns indicate the comparative rating of group according to mean total length in each sorting.

*mlc2a/mlc2b* expression levels dramatically decreased from S1 to S2 and S3 ( $P < 0.001$ , Figure 6), mainly due to an increase in *mlc2b* expression. Notably, a reverse relationship was observed between total length and *mlc2a/mlc2b* expression in the groups created in S1 and S2; the higher the *mlc2a/mlc2b* expression, the shorter the total length. This relationship was not detected with the same consistence in S3 (Figure 6).

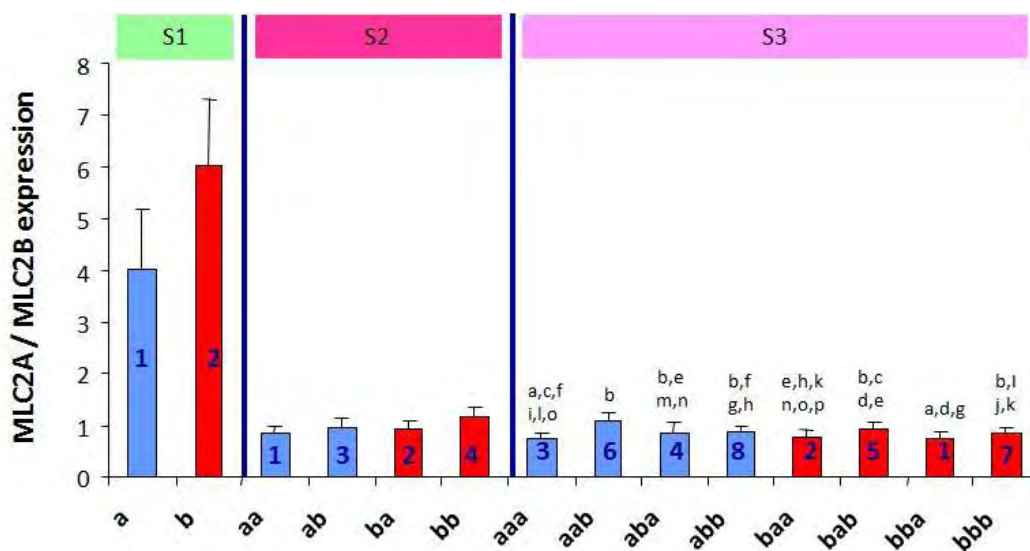

**Figure 6:** *mlc2a/mlc2b* expression levels (mean ± SEM) in the groups of gilthead sea bream generated in three successive size-sortings (S1, S2, S3). Blue and red columns indicate the derivate groups of *a* and *b*, respectively. Groups within each sorting sharing the same letters are not statistically different ( $P < 0.05$ ). Numbers within the columns indicate the comparative rating of group according to mean total length in each sorting.

Spearman rank correlation analysis did not reveal a significant correlation between *mlc2a* expression levels and total length in any of the sorting stages (Figure 7A). On the contrary, *mlc2b* expression levels were significantly correlated to total length increment ( $R = 0.773$ ,  $P = 0.039$ , Figure 7B), with tight correlations observed during S1 and S2. However, this correlation became insignificant by S3. No correlation was detected between *mlc2a* and *mlc2b* expression in S1 ( $R = 0.008$ ) and S2 ( $R = 0.185$ ). This correlation appeared to increase with increasing size and age to become significant by S3 ( $R = 0.326$ ). *mlc2a/mlc2b* levels on the other hand were significantly and highly correlated to total length ( $R = -0.707$ ,  $P = 0.000$ , Figure 7C) at each sorting stage and throughout the entire experimental period. A rapid decrease in

*mlc2a/mlc2b* expression was observed with increasing length in S1 that slowed down during S2 and S3 (Figure 7C).

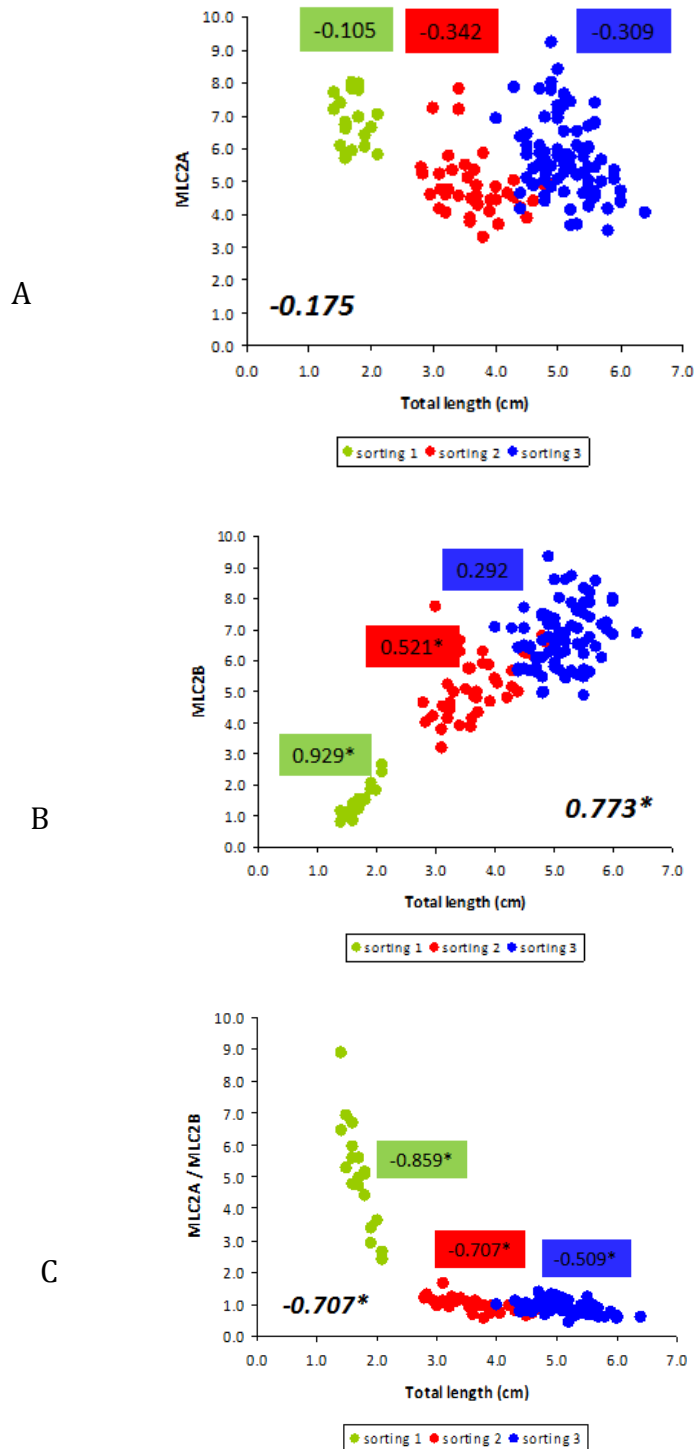

**Figure 7:** Correlation between (A) *mlc2a*, (B) *mlc2b*, (C) *mlc2a/mlc2b* expression levels and total length in gilthead sea bream after three size-sortings. Individual measurements are presented. Spearman correlation coefficients are given for each sorting in color frames; sorting 1, green; sorting 2 red; sorting

*Chapter Σφάλμα! Χρησιμοποιήστε την καρτέλα "Κεντρική σελίδα", για να εφαρμόσετε το  
Heading 1 στο κείμενο που θέλετε να εμφανίζεται εδώ.*

---

3, blue. Spearman correlation coefficients for the entire experimental period are given in italics. Significant correlations are marked with an asterisk.

## **5.4 Discussion**

Different rearing practices employed at the hatchery stages significantly affected gilthead sea bream growth performance and *mlc2* isoform expression. More importantly, significant correlations were detected between *mlc2* isoform expression and axial growth supporting further the validity of *mlc2* isoforms as candidate markers of growth performance.

Fish farming industry aims at healthy larvae of predictable growth performance with the highest possible biomass gain as juveniles. Inherent growth capacity exhibited by fish species or strains is dictated by the genotype and the interaction with the environment. Despite the perpetual efforts differential growth rates resulting in size disparity is a major bottleneck still unsolved in aquaculture practice. Physiological status in terms of food utilization, swimming ability, metabolic capacity and the allocation of energy to growth are key factors determining growth potential. Exogenous factors, such as temperature, salinity, light intensity, food availability and quality also have a large impact on growth performance. Hatchery practices determine stocking density and social interactions, larvae initial size disparity, hatching time, age and size at metamorphosis within a given population and can ultimately promote or delay growth (Kestemont et al. 2003; Onders et al. 2011). The advent of molecular markers with the capacity to predict growth performance at early stages would be of paramount importance in aquafarming. Selecting for strains or batches of faster growing individuals would increase profitability and contribute to the sustainability of the aquaculture sector.

White muscle phenotypic plasticity is the genetic-driven response to environmental stimuli, such as abiotic factors and prey availability (Johnston 1999, 2006). The bulk of white musculature is supported by the skeleton and in this sense, the size of the axial skeleton may become a limiting factor to growth. Early developmental events are crucial in constructing the skeletal scaffold that will subsequently accommodate the developing muscle and total larvae length was selected as growth measure at the early stages in the present study.

Mean length of mesocosm-reared larvae differentiated from that of the intensively-reared ones from 35 dph onwards. As previously observed (Chapter 4) 35 dph represents a transitional stage in gilthead sea bream development when hypertrophy takes over hyperplasia.

Indeed, by 45 dph both *mlc2a* and *mlc2b* expression that mark hyperplasia and hypertrophy respectively (Chapter 4), are higher in mesocosm-reared larvae (Figure 3) indicative of accelerated growth events in the musculature that might be accompanied by relevant processes in the axial skeleton. The difference between the mean length of mesocosm- and intensively-reared larvae kept increasing up to the end of recording period (55 dph) and it coincided with an abrupt decrease in *mlc2a* expression in mesocosm-reared individuals by 81 dph, whereas it persisted at stably high levels in intensively-reared ones. This negative correlation, albeit not significant, between *mlc2a* expression and axial growth was also confirmed in experiment 2 (Figure 7A) reinforcing the hypothesis that the faster replacement of MLC2A by MLC2B post-metamorphosis may provide an indication of faster growth. In support to this hypothesis, in experiment 2 *mlc2b* expression was significantly and positively correlated to axial growth (Figure 7B). An almost linear relationship of *mlc2b* to mean total length in juveniles underscored the importance of this isoform in muscle formation post-metamorphosis. This correlation appeared to weaken with age and size pointing to a differentiation in regulatory tuning between muscle and axial growth.

However, the tightest correlation was observed between *mlc2a/mlc2b* expression and axial growth that was highly significant throughout experiment 2. The ratio of expression of *mlc2* isoforms was more consistently linked to growth compared with the individual isoform expression (Figure 7A-C). Similarly, when mean expression levels and mean length were compared (Figures 4-6) *mlc2a/mlc2b* expression was lower in groups of higher mean length. In addition, this negative correlation was implied in experiment 1 that *mlc2a/mlc2b* expression was 3.5-fold higher in the smaller intensively-reared individuals by 45 dph (Figure 3C). Taken the present results together it is encouraging that the ratio of expression of *mlc2* isoforms was significantly and consistently linked to axial growth in cohorts of gilthead sea bream of different origin and treatment during early development. Given the plastic versatility prevailing early development, the present results provide strong evidence of the robustness of *mlc2* isoforms as markers of early growth.

Increased *mlc2* expression accompanied the higher rates of muscle hyperplasia in coho salmon (*Oncorhynchus kisutch*) transgenic for a growth hormone gene construct (Hill et al. 2000). Body protein gain and *mlc2* expression were also positively correlated in fast muscle of Senegalese sole, indicative of a close relationship of *mlc2* expression and growth performance in juveniles (Campos et al. 2010). Although different *mlc2* isoforms have not been identified yet in Senegalese sole, ClustalW alignment to gilthead sea bream *mlc2b* (data not shown) indicated

that in the latest study the authors were probably studying the expression of *mhc2b* isoform, underscoring *mhc2b* isoform relationship to muscle growth in both species. New muscle fiber formation in the juvenile stages has been correlated to myosin heavy chain gene in carp (Enion et al. 1995). Furthermore, expression of fast myosin heavy chain was correlated to growth rate and protein turnover in rainbow trout under variable nutritional status (Overturf & Hardy 2001; Alami et al. 2010a) as well as to muscle protein accretion in Atlantic salmon (Hevroy et al. 2006). During early larval and juvenile/adult stages variations in temperature also were shown to affect myosin heavy chain expression in a species- and developmental stage-specific manner yet hypertrophy and hyperplasia were not studied (Gerlach et al. 1990; Wilkes et al. 2001; Xie et al. 2001).

Pre-metamorphic larvae reared in the mesocosm technology express both isoforms in higher levels and present greater total length indicating that in the larval period mesocosm technology favors faster growth. Improved growth in fish cultured under the mesocosm system was also observed for the same species (Çoban et al. 2009; Andrade et al. 2012) as well as for European sea bass and white sea bream (*Dicentrarchus labrax*, *Diplodus sargus*, Divanach & Kentouri 2000). Furthermore, gilthead sea bream raised under the mesocosm strategy appeared to be in a better shape as limited mortality, better swimbladder development (Andrade et al. 2012), less skeletal abnormalities (Divanach & Kentouri 2000; Boglione et al. 2001) were recorded. Larval growth appeared to be favored in the mesocosm system, although not significantly, yet it is difficult to determine which of the variables in the culture conditions contributed the most; stocking density, rearing enclosures (type, size, indoor or outdoor facilities), prey source (food chain versus exogenous food) and availability, water quality and renewal are some of the known factors playing key roles in larvae and juvenile feeding and growth (Divanach & Kentouri 2000; Zouiten et al. 2011). In the present study, the more natural mesocosm environment has proven to be more appropriate both for gilthead sea bream larvae in the sensitive pre-metamorphic period. Marketable quality of intensively-reared gilthead sea bream was lower compared with the mesocosm-raised individuals usually due to changes of the shape of the fish and the progressive loss of the natural external appearance (Flos et al. 2002; Valente et al. 2011). Metabolism and muscle physiology was also influenced by the rearing method since priority was given in fat deposition and muscle fiber synthesis in fish cultured in the intensive system (Del Coco et al. 2009; Valente et al. 2011). Many studies have stressed the importance of the genetic determinism over body growth (Valente et al. 1999, 2011; Johnston 2006). Special care was taken to minimize inter-individual genetic variability in



both experiments by limiting the number of broodstock used. However, environment-genotype interactions would be interesting to be evaluated.

In gilthead sea bream production size-sorting is a widely used technique in order to compensate growth differences among specimens of the same cohort. Size-sorting is labour-intensive, requires more personnel and may induce additional handling stress depending on fish species (Pickering 1981; Jensen 1990). The results obtained here indicate that the size-grading method improves modestly gilthead sea bream somatic growth. It is highly possible that even in a highly frequent size-grading system dominant interactions among the same size-at-age individuals are quickly reestablished which is expected to lead to disproportional access to food acquisition and food wastage (Jobling & Reinsnens 1987; Sunde et al. 1998; Zakęs et al. 2004).

In conclusion, *mlc2* expression was shown to follow the hyperplastic and hypertrophic events of muscle growth in gilthead sea bream (Chapter 4), while *mlc2a/mlc2b* expression was significantly correlated to axial growth during the larval and early juvenile stages. Comparison of cohorts of gilthead sea bream of different origin, raised under different conditions and of different developmental stages (larvae vs juveniles) provided significant evidence for the robustness of *mlc2* expression as a marker of growth and pointed to observations warrant further investigation; whether the speed of replacement of MLC2A by MLC2B at metamorphosis is a marker of growth potential and how *mlc2a/mlc2b* expression follows growth fluctuations throughout the life cycle in gilthead sea bream.

*Chapter Σφάλμα! Χρησιμοποιήστε την καρτέλα "Κεντρική σελίδα", για να εφαρμόσετε το  
Heading 1 στο κείμενο που θέλετε να εμφανίζεται εδώ.*

---

## ***Chapter 6***

*Chapter Σφάλμα! Χρησιμοποιήστε την καρτέλα "Κεντρική σελίδα", για να εφαρμόσετε το  
Heading 1 στο κείμενο που θέλετε να εμφανίζεται εδώ.*

---

## Chapter 6

### General Discussion

#### 6.1 General discussion

In gilthead sea bream (*Sparus aurata*, L), two isoforms of the regulatory myosin light chain 2 (*mlc2*) have been isolated and characterized that encode for the same 170 aa peptide but differ in the 3' untranslated region (Moutou et al. 2001; Sarropoulou et al. 2006). *mlc2* isoform A (*mlc2a*) contains three potential polyadenylation signals in the 3' UTR generating three alternative transcripts through alternative polyadenylation site selection. Regarding their tissue distribution, *mlc2a* transcripts expression was restricted in white and red muscle. *mlc2* isoform B (*mlc2b*) exhibited a pleiotropic expression pattern with transcripts detected in all tissues examined (red, white, smooth and cardiac muscle, kidney, liver, spleen, brain, gills, epidermis) (Sarropoulou et al. 2006). Hybridization *in situ* showed that isoform A expression marks the newly formed white fibers and post-metamorphosis it is limited to small cells located in the inter-fiber space, most probably myogenic cells (Moutou et al. 2005).

#### ➡ *MLC2 isoforms are products of different genes*

The organization of the genes encoding for the two *mlc2* isoforms was predicted in gilthead sea bream using comparative genomics analysis (Chapter 2). *Mlc2a* and *mlc2b* predicted gene organization is conserved among teleosts as revealed by synteny analysis with model and non-model fish species. *Mlc2a* gene is composed by five exons separated by four introns whereas *mlc2b* gene is composed by six exons separated by five introns in European sea bass, zebrafish, Atlantic cod, three-spined stickleback, medaka and tetraodon. Exon-intron organization of gilthead sea bream of both *mlc2* genes and the spanning sequence of each exon/intron is more similar among evolutionary closer species which is further confirmed by the phylogenetic tree and is in agreement with already published data (Steinke et al. 2006; Sarropoulou et al. 2007, 2008; Near et al. 2012). Established syntenic relationship of gilthead sea bream to European sea bass (Sarropoulou et al. 2008) allowed the mapping of *mlc2* genes in the radiation hybrid (RH) map of gilthead sea bream; *mlc2a* was mapped on group RH11 and

*mlc2b* on group RH24. Given the low degree of evolution of medaka genome following the teleost-specific whole genome duplication and the high degree of conservation of *mlc2* genes, the evolutionary origin of *mlc2* isoforms were traced to proto-chromosomes *d* and *e*, in common with other myosin genes (Ikeda et al. 2007).

#### ➡ *cis-acting regulatory elements residing in the 3' UTRs of mlc2a alternative transcripts*

*Mlc2a* expression control is exerted through alternative polyadenylation signals and by *cis-acting* sequences lying in the 3' untranslated region (Chapter 3). Bioinformatic analysis revealed in total 1, 2 and 4 polyadenylation signals in *mlc2a*-short, -medium and -long alternative transcripts, respectively, and an additional unusual form of polyadenylation signal in *mlc2a*-medium and *mlc2a*-long transcripts. Unusual polyadenylation signals provide an extra level of gene regulation dynamics. In humans polyadenylation proceeds less efficiently using the unusual forms of polyadenylation sites and they may consist deleterious signals controlling mRNA processing (Beaudoing et al. 2000). Polyadenylation signal selection, in which CPSF binds, is based on flanking sequences apart from the consensus hexanucleotide. A U-rich sequence located downstream of the polyadenylation signal recruits CstF (diGiammartino et al. 2011) and is also detected in *mlc2a* alternative transcripts stressing the importance of *mlc2a* fine-tuned polyadenylation in regulation of expression and translation.

The *cis-acting* regulatory elements residing in the 3' UTR are bound by *trans-acting* factors, such as RNA-binding proteins and/or miRNAs, inducing mRNA degradation and hence inhibition of translation (diGiammartino et al. 2011; Alonso 2012). mRNA localization signals as well as sequences controlling mRNA processing and activation or stall of protein synthesis were detected in *mlc2a* alternative transcripts 3' UTRs. All three *mlc2a* alternative contain uORFs that were found to induce mRNA degradation in human genes (Calvo et al. 2009). Medium and long transcripts bear many more uORFs suggesting that these mRNAs are more prone to decay than the short transcript. Indeed, *mlc2a*-short was in high abundance in all cases determined as expected from its 3'UTR structure. Target sites of *lin-4* miRNA were found in *mlc2a* alternative 3' UTRs proposing a role in the developmental transition from larvae to adult stages in this species, which was confirmed in developing larvae (Chapters 2 and 4). The cytoplasmic polyadenylation element (CPE), the motif responsible for impairing translational efficiency in yeast and *Xenopus*, respectively (Moor & Richter 1999; Vilela et al. 1999), was also detected in both *mlc2a*-medium and -long transcripts mounting evidence for their impaired efficiency.

However, this assumption was not supported by the comparison of function of *mlc2a*-small vs *mlc2a*-medium and -long transcripts in CHO cell line.

#### ➡ *mlc2a* 3' UTRs modify gene expression in vitro

Functionality of 3' UTRs was studied in luciferase reporter vectors introduced to the CHO cell line using the transient mode of transfection for the immediate expression of the inserted DNA element. The highest luciferase expression was observed in cells transfected with *mlc2a*-medium and *mlc2a*-long 3' UTR constructs. Although, truncated transcripts are known to be favored under the high gene expression rates of cells for producing more protein in a cell culture (Mueller et al. 2013) *mlc2a*-short did not fall into this observation, despite less *cis*-acting down-regulating elements predicted in short transcript 3' UTR. Translation efficiency and post-transcriptional modifications of mRNA molecules with longer 3' UTRs are dependent on the foldings mRNAs can adopt. Overall, *mlc2a*-medium and *mlc2a*-long transcripts appeared to be more thermodynamically stable than *mlc2a*-short and therefore their expression was proved more favored.

The long transcript is subject to delicate control driven by more *cis*-acting localization and translation signals. Attenuation of *mlc2a*-long gene expression may be dictated by the Mushashi binding element (MBE), a context-specific regulator of translation (Arumugam et al. 2010; Nickerson et al. 2011) located in its 3' uncoding region. Sub-cellular compartmentalization of *mlc2a*-long transcript may be guided by the M1 motif first identified in yeast (Shalgi et al. 2005). *mlc2a*-long mRNA localization in mitochondrial surface may be an alternative way for the spatial control of gene expression enhancing it in the sub-cellular compartments that it is going to be used. Localization signals have been also found in myosin heavy chain (MHC) molecules in other organisms. Localization of slow and fast MHC in rat skeletal muscle fiber periphery alternatively to its uniform distribution were also suggested to be determined by motifs residing in 3' UTRs which are not conserved between rat and mouse (Kiri & Goldsprink 2002). Experimental evidence for a localization signal of the slow skeletal MHC driving mRNA to the perinuclear cytoplasm in myoblasts and early myotubes came from studies with b-globin-MyHC 3' UTR hybrid mRNA. The signal sequence guiding the sub-cellular distribution has not been determined (Wiseman et al. 1997).

It has been suggested that longer 3' UTRs possess more signals and are more prone to degradation due to their instability (diGiammartino et al. 2011; Alonso 2012). More *cis*-acting regulatory elements predicted in medium and long transcripts possibly infer greater instability

in these transcripts compared to the short transcript. A cellular mechanism to compensate inhibition of translation could be to augment transcriptional activity as in the case of increased transcriptional activity reflected in enhanced luciferase activity of *mlc2a*-long construct compared to *mlc2a*-medium construct as well as increased luciferase activity of both medium and long constructs compared to the short construct. Furthermore, the presence of more translational repression *cis*-acting elements, a less thermodynamically stable structure compared with the medium transcript as predicted by mfold program and the highest luciferase activity observed in cells transfected with the long construct suggest that the long transcript is a highly unstable molecule and needs to be expressed in a higher rate in order to exert its biological actions.

Enhanced luciferase activity of the *mlc2a*-long contradicts expression data in which the *mlc2a*-short transcript is the major transcript (Chapter 2). The discrepancy observed could be attributed to the nature of the molecules tested; only the 3' UTR was incorporated in the cell constructs, which might have attained an altered secondary structure or might have lacked other synergistic sequences or factors absent from the CHO cell line. Expression of the transcript with the shorter 3' UTR prevails in the myogenic environment of white muscle under the regulation of myogenic factors that are absent from the mammalian ovary cell line. *mlc2a*-short may be the transcript of choice in the highly dynamic environment of differentiation and development due to its thermodynamic instability; differentiation runs in fast pace and gene regulation mechanisms must follow that pace. Under such conditions, an instable transcript could be removed more quickly than a stable one, and cancellation of protein synthesis would be immediate. Similarly, a high number of instable transcripts would be required on high demand of the peptide they encode for, and specific transcription factors – like myogenic factors – would be responsible for keeping high the production of the instable transcript.

An alternative explanation to cumulative data from *in vivo* (Chapter 2) and *in vitro* (Chapters 2 & 3) studies could be that the short transcript might serve as a negative regulator of the other two transcripts. In the highly changing myogenic environment, should the short transcript regulate the expression of the other two transcripts it would need to be highly abundant. In non-myogenic CHO cells transfected with either medium or long constructs in the absence of the short construct, this negative control imposed by the short construct was abolished and both medium and long constructs were largely expressed while co-transfection with the *mlc2a*-short construct resulted in reduced luciferase activity in every case. It remains

to be investigated whether the myogenic environment would differentiate the picture seen in CHO cell line.

Co-transfection with two or all three 3' UTR constructs was used as an experimental model to study the dynamic preference over 3' UTR structures within cells and any possible interaction between the alternative transcripts. The display of comparable expression levels of medium and long transcripts in either myogenic or CHO environment questions the purpose of the existence of two alternative transcripts with similar transcriptional-translational potential. There is high possibility that both transcripts have alternate intracellular fates. mRNAs not currently used by the translational protein machinery they tend to accumulate in cytoplasmic foci called P-bodies and they are released upon request (Parker & Sheth 2007). In this scenario, long or medium transcripts could be stored transiently in P-bodies until cell decisions about proceeding to degradation or return to translation are made. This scenario could also explain the low transcription rate of either medium or long transcript observed in developing larvae and in primary myocytes: storing in P-bodies would save cell energy from producing new transcripts while increase translational availability in the times of need during muscle protein synthesis, also confirmed in CHO cells displaying the highest luciferase activity when transfected with both medium and long constructs. Compartmentalization is also a possibility; M1 localization motif predicted only in the long 3' UTR might drive long transcripts in close vicinity with mitochondria. Compartmentalization and localization in different sub-cellular organelles could increase mRNA half-life in the cell and increase translational efficiency while preventing mRNA degradation.

#### ➡ *Gilthead sea bream *mlc2* isoforms: a paradigm of divergent evolution*

MLC2 isoforms in gilthead sea bream make a good paradigm of divergent evolution of *cis*-regulatory elements. The minimal degree of conservation observed between the 3' UTR sequences of *mlc2a* and *mlc2b* (Sarropoulou et al. 2006) point to the existence of different regulatory mechanisms in all aspects governed by the 3' UTRs. In addition, the isolation of three alternative transcripts of *mlc2a* reinforces the idea that different regulatory mechanisms have evolved for the two isoforms of *mlc2* in gilthead sea bream as expected for duplicated genes on divergent trajectories. MLC2 isoforms share the same function as constituents of the myosin molecule. However, clear transitions in the expression of *mlc2a* and *mlc2b* were observed in primary muscle cell cultures and during development in gilthead sea bream. Each isoform is up-



regulated at different phases of myogenesis and muscle growth and they are differentially affected by growth hormone. These findings together with the large *mlc2a* and *mlc2b* clusters of potential homologues in teleost species in the phylogenetic analysis suggest that MLC2 isoforms have undergone subfunctionalization and are products of paralogue genes.

#### ➤ *mlc2a* marks myocyte differentiation

In primary muscle cell cultures from gilthead sea bream *mlc2a* expression was consistent to capacity of myocytes to differentiate and the timing of events was as previously described (Montserrat et al. 2007, Chapter 2). *Myogenin* and *mlc2a* exhibit similar and significantly correlating expression during the differentiation phase of the myocytes highlighting *mlc2a* important contribution to muscle formation. The presence of six E-boxes, binding sites to bHLH myogenic factors in *mlc2* promoter, provide a possible link between the action of the myogenin as an inducer of differentiation in myocytes and the up-regulation of *mlc2a* upon myocyte differentiation (Funkenstein et al. 2007; Ferri et al. 2009).

#### ➤ *mlc2* isoforms follow muscle development

Gene expression of *mlc2* isoforms and genes-key players in the myogenetic process was investigated in 15 to 60 days post hatch gilthead sea bream larvae coupled with cellularity measurements to identify hyperplastic and hypertrophic events (Chapter 4). *mlc2a* expression levels were elevated from 15 to 35 dph larvae accompanied by a dramatic increase in total fiber number (TFN), an established indicator of growth potential, and the high levels of very small diameter muscle fibers, indicative of new muscle formation. *mlc2b* expression levels were increased concomitantly with an increase in muscle fiber diameter. Overall, expression levels of *mlc2* isoforms followed very closely the formation and increase in diameter of muscle fibers and clearly distinguished the hyperplastic and hypertrophic phase of muscle formation; expression of *mlc2a* followed the hyperplastic pattern of muscle growth, i.e. new fiber formation until 35 dph, whereas it was dramatically down regulated when muscle cell proliferation came to a pause between 35 and 60 dph and hypertrophy took over as the main mechanism of muscle growth. Contrary to that pattern, *mlc2b* significantly increased only pre-metamorphosis when new fibers were not any longer formed. Consistent with these results, *in situ* hybridization experiments revealed *mlc1*, *mlc2* and *mlc3* transcripts in the larval germinal zones and in the

*Chapter Σφάλμα! Χρησιμοποιήστε την καρτέλα "Κεντρική σελίδα", για να εφαρμόσετε το  
Heading 1 στο κείμενο που θέλετε να εμφανίζεται εδώ.*

---

newly formed white muscle fibers dispersed in the juvenile (70 dph) blackspot sea bream fast muscle, marking hyperplasia (Silva et al. 2010).

### ➤ Links of *mlc2a* and *mlc2b* expression with transcriptional and hormonal factors

MLC2 isoforms intriguing role during muscle formation was further correlated to genes involved in muscle cells commitment and differentiation processes. Muscle differentiation is a complex process that requires the combined action of certain transcription factors, the myogenic regulatory factors (MRFs), the expression of which is finely tuned both temporally and spatially (Ferri et al. 2009). Myogenin and MRF4 drive middle and terminal differentiation phases while regulating the expression of genes encoding proteins of the sarcomeric assembly, like the myosin light chain 2 of gilthead sea bream (Buskin & Hauschka 1989; Wright et al. 1991). The significant positive correlation between the expression of myogenin and *mlc2a* transcripts both of which are elevated during the phase of intensive formation of new fibers, evidenced both by primary muscle cultures and gene expression data from the early developmental stages, reinforces the notion that myogenin might also be a candidate marker of hyperplastic growth. Additional evidence comes from rainbow trout larvae in which myoD and myogenin are considered markers of myogenic cell recruitment during the stratified hyperplastic growth (Steinbacher et al. 2007). MyoD2, white muscle specific gene in gilthead sea bream (Tan & Du 2002), exhibited the highest expression at 36 hpf and after that point, it was stably expressed throughout gilthead sea bream development. In primary muscle cell cultures MyoD2 was expressed at low levels and contrary to *mlc2* expression pattern, it exhibited a continuous gradual increase throughout the proliferation and differentiation phase, confirming its role as a transcription factor inducing myoblast differentiation (Ferri et al. 2009). *Mrf4* expression remained at low stable levels throughout sea bream development. The small rise in *Mrf4* expression at 15 dph is indicative of its role in myocyte determination rather than differentiation. *Mrf4* expression starts increasing slowly, although not significantly, after 45 dph reinforcing its role in hypertrophy (Knight & Kothary 2011). MRFs expression trends are in line with contemporary hypothesis that MyoD, Myf5 and *Mrf4* together define muscle identity and that muscle differentiation is driven by MyoD, myogenin and *Mrf4* (Kassar-Duchossoy et al. 2004; Ferri et al. 2009).

Myostatin is considered to be an inhibitor of proliferating myoblasts and a major negative regulator of fiber number (Ostbye et al. 2001). *mstn-1*, one of the two myostatin paralogues identified in gilthead sea bream (Maccatrozzo et al. 2001; Nadjar-Boger &

Funkenstein 2011), is predominantly expressed in muscle and MSTN-1 gene polymorphism has been associated with growth traits (Sanchez-Ramos et al. 2012). Consistent with its growth inhibitory role, *mstn-1* expression was previously reported to be low in sea bream during the early developmental stages (1 to 44 dph) (Maccatrozzo et al. 2001). In the current study however, *mstn-1* had the same expression pattern as *mlc2a* and transiently peaked on 35 dph, pointing to a possible role on regulating the shift from hypertrophy to hyperplasia. Further proof that myostatin acts on the switch from proliferating to the differentiating state of myoblasts comes from C2C12 cell line cultured with recombinant bovine myostatin. Myostatin inhibited myoblast proliferation by arresting myoblasts cell cycle to G1 phase prior to the S phase of DNA synthesis. Subsequently, myostatin levels increased during myoblasts fusing to multinucleated myotubes, controlling terminal differentiation and myotube formation (Budasz-Świdarska et al. 2005). In the same myogenic cell line myostatin was detected in the myotubes but not in the myoblasts (Artaza et al. 2002) and its up-regulation was initiated with nuclei accretion. During the hypertrophic stage myostatin was localized within the nuclei suggesting it may have a role as a transcription factor. The stage-specific myostatin expression overlapped with strong up-regulation of the major myosin heavy chain isoform MHC-II and to a lesser degree with MHC-I (Artaza et al. 2002). A similar phenomenon was observed from hierarchical gene clustering, as *mstn-1* did not group with the other regulatory genes studied (*igf-I*, follistatin, myogenin, *mrf4*) but it fell within the cluster of structural genes. An up-regulation of myostatin expression levels coincided with the earliest signs of muscle activity in post-hatching tilapia larvae (Rodgers et al. 2001), a myostatin expression trend also observed by gilthead sea bream larvae herein. In agreement with this, myostatin biological actions are not restricted to skeletal muscle with transcripts detected in other tissues in gilthead sea bream such as brain, eye, pyloric caeca among others, possibly regulating their growth (Funkenstein et al. 2009). These data combined together point to a versatile regulatory action of the myostatin molecule during ontogeny that is worth revisiting.

Myostatin action is antagonized by follistatin in mammals and chicks and several observations have connected follistatin to positive muscle growth (Matzuk et al. 1995; Lee & McPherron 2001; Amthor et al. 2004). Follistatin expression declined slowly up to metamorphosis and it was significantly and negatively correlated with *mstn-1* expression. Follistatin-myostatin antagonistic interaction along with follistatin positive correlation to myogenin expression levels suggests that follistatin's action associates more with the hyperplastic than the hypertrophic phase of muscle growth. In line with this, follistatin

promoted myocyte fusion *in vitro* and muscle regeneration *in vivo* acting downstream of mTOR pathway which involves MyoD-dependent expression of miR-1 (Sun et al. 2010).

Growth hormone is a pluripotent endocrine regulator of all the major growth pathways in fish. Its tissue-specific actions are exerted by the IGFs that are locally produced and act at a paracrine-autocrine function whereas there is evidence that growth hormone may be also a single player (Bjornsson et al. 2002). Given that white musculature consists approximately 70 % of the teleost body, the expression, synthesis and deposition of sarcomeric proteins represents the ultimately process of growth. Both *mhc2* isoforms expression was under the regulation of growth hormone (Chapter 2). *Mhc2* expression was augmented significantly by growth hormone treatment in a non dose-dependent manner that adds to the systemic supervision of growth by growth hormone, although the steps of this supervision were not deciphered. However, the timing of the induction differed between the two isoforms. The absence of growth hormone-driven induction of myogenin may point to a shift in the regulatory mechanisms governing growth in juveniles when muscle phenotype is already established as opposed to the early development. This finding warrants further investigation as it opposite to co-elevation of *igf-1*, myogenin and *mhc2* (probably *mhc2b*) expression levels in juvenile Atlantic salmon following a starvation period (Bower et al. 2008).

Total IGF-1 transcripts did not display any fluctuation at the transition between hyperplasia and hypertrophy in accordance with the findings of Perrot et al. (1999), who observed stable low IGF-1 expression levels throughout early development in sea bream. However, IGF-1 expression was significantly and positively correlated with the expression of the muscle structural genes under investigation and the expression of myogenin proposing a collateral role in terminal differentiation and hypertrophic growth.

### *mhc2a and mhc2b: markers of growth?*

Growth performance of fish species or strains has a genetic component, and manipulating the interaction of genotype with the environment is the goal of aquaculture managers. Gilthead sea bream larvae and juveniles reared in the more wild-like mesocosm system outperformed those intensively-reared in terms of axial growth (Chapter 5). Pre-metamorphic larvae reared in the mesocosm technology expressed both isoforms at higher levels and they underwent a faster transition from isoform A to B. In connection with results of

Chapter 4 where it was evident that *mlc2a* is a marker of hyperplasia and *mlc2b* a marker of hypertrophy, a quick shift between the hyperplastic and hypertrophic growth processes might have occurred in mesocosm-reared larvae.

Differential growth is an undesired phenomenon in fish farming that results in size disparity, a major bottleneck still unsolved. In largely produced gilthead sea bream size-sorting is a widely used technique in order to improve biomass gain and compensate growth differences among the same cohort specimens. Successive size-sortings of gilthead sea bream juveniles with three increasing diameter sorters improve only modestly somatic growth. *mlc2a* expression was inversely correlated to axial growth, observed in both experiments, whereas *mlc2b* expression was significantly and positively correlated to axial growth. An almost linear relationship of *mlc2b* to mean total length in juveniles stressed the importance of this isoform in muscle formation post-metamorphosis. These findings strengthen the hypothesis that the faster replacement of MLC2A by MLC2B post-metamorphosis may provide an indication of faster growth.

In both independent experiments run according to commercial practice in cohorts of gilthead sea bream of different origin and treatment during early development, *mlc2ba/mlc2b* ratio provided a significantly consistent correlation with axial growth in+ larval and juvenile stages. *mlc2a/mlc2b* ratio diminished abruptly post-metamorphosis and later on followed the prevailing *mlc2b* expression. Given the plastic versatility prevailing early development, the present results provide strong evidence of the robustness of *mlc2* isoforms as markers of early growth.

Overall, the data presented herein suggest that MLC2 isoforms represent robust molecular markers of muscle development and growth in gilthead sea bream, as they appear to fulfill certain prerequisites; they were correlated to established muscle growth markers, their expression followed the muscle developmental program, they were under the GH-IGF axis regulation and they were consistently correlated with axial growth in gilthead sea bream. The development of such markers predicting growth potential and juvenile quality in early life stages could contribute significantly to optimization of aquaculture practices.

## **6.2 Concluding remarks**

The results of the present thesis suggest that the two isoforms of myosin light chain 2 of gilthead sea bream are under differential developmental regulation exhibiting specific both unique and overlapping expression time-windows during ontogeny. The dynamic plasticity of *mlc2* isoforms reflects muscle cellularity in early life and subsequent juvenile period. *mlc2a* dominates the early stages in ontogeny holding a part in the complex myogenic network. *mlc2b* is the juvenile isoform prevailing after the metamorphic climax correlating tightly with total length. *mlc2ba/mlc2b* ratio illustrates growth potential and can be successfully incorporated to aquaculture practices. Over and above, correlation to established growth markers and regulation under the growth hormone axis emphasize their validity as useful markers of juvenile gilthead sea bream growth capacity.

*Chapter Σφάλμα! Χρησιμοποιήστε την καρτέλα "Κεντρική σελίδα", για να εφαρμόσετε το  
Heading 1 στο κείμενο που θέλετε να εμφανίζεται εδώ.*

---



## **Future Directions**

This PhD thesis has explored aspects of the regulation of myosin light chain 2 and demonstrated its robustness as a molecular marker of early and juvenile growth. Obtained results have arisen more questions:

- Although *mlc2a* and *mlc2b* expression has been linked to regulatory molecules involved in the myogenetic process, the mechanisms by which this interaction is accomplished need to be elucidated. Identifying the nature of mRNA-protein interactions in the muscle, the region (probably the 3' UTR) necessary for protein binding and the possible other co-factors will provide further clues of the tight regulation of muscle formation in teleosts. Interactions of MLC2 protein with other members of the cytoskeleton should be assessed. Also, the intriguing correlation of myostatin and *mlc2* questions the established role of myostatin as a negative regulator of muscle growth and requires further investigation.

- Differential expression levels of *mlc2a* alternative transcripts have been revealed to follow primary myocytes formation and white muscle development. *mlc2a*-short transcript expression prevails, *mlc2a*-medium is the second in expression levels followed very closely by *mlc2a*-long. Precise role of alternative transcripts of *mlc2a* during gilthead sea bream development and during the myogenetic process should shed some light on reasons for their existence since the cellular energetic expenditure is greater for three transcripts instead of one. Sub-cellular localization experiments with immunohistochemical and immunocytochemistry techniques can reveal the specific compartments each transcript localizes or over-lapping roles when they co-localize.

- Bioinformatic analyses on 3' UTRs of alternative transcripts of *mlc2a* have revealed *cis*-acting sequences regulating its expression. Experimental evidence proving their role in post-transcriptional gene processing, the mechanisms, the timing and the final outcome must be obtained. Functional role of the predicted *cis*-acting sequences can be examined in site-directed mutagenesis experiments, where each *cis*-acting sequence can be deleted and the final outcome can be assessed with *in vitro* transcriptional/translational systems. Current knowledge encourages the searching of many more trans-acting factors that modulate transcripts expression patterns. Present work suggested a model about functionality of *mlc2a* 3' UTRs *in vitro*. Cell culture assays with myogenic cell lines, such as C2C12 will add more pieces to this puzzle.

- 3' UTR of isoform B and possible alternative transcripts should be further explored. Comparisons to *mlc2a* will enable a better understanding of the existed data as well as it will provide further clues regarding *mlc2* gene regulation during gilthead sea bream ontogeny.
- Further experiments should aim at studying the response of *mlc2* expression under fasting/refeeding cycles, differential nutritional regime as well as temperature and pH fluctuations. The results will fill our gaps in optimal diets or optimal ambient conditions for this highly valuable species of Mediterranean aquaculture.

*Σφάλμα! Χρησιμοποιήστε την καρτέλα "Κεντρική σελίδα", για να εφαρμόσετε το  
Bibliography στο κείμενο που θέλετε να εμφανίζεται εδώ.*

---

## ***References***

*Σφάλμα! Χρησιμοποιήστε την καρτέλα "Κεντρική σελίδα", για να εφαρμόσετε το  
Bibliography στο κείμενο που θέλετε να εμφανίζεται εδώ.*

---

---

## References

- Abràmoff, M.D., Magalhães, P.J., Ram, S.J.** (2004) Image processing with ImageJ. *Biophoton. Internat.* 11(7): 36-42
- Aburomia, R., Khaner, O., Sidow, A.** (2003) Functional evolution in the ancestral lineage of vertebrates or when genomic complexity was wagging its morphological tail. *J. Struct. Funct. Genom.* 3(1-4): 45-52
- Addis, M.F., Cappuccinelli, R., Tedde, V., Pagnozzi, D., Porcu, M.C., Bonaglini, E., Roggio, T., Uzzau, S.** (2010) Proteomic analysis of muscle tissue from gilthead sea bream (*Sparus aurata*, L.) farmed in offshore floating cages. *Aquacult.* 309: 245-252
- Ainger, K., Avossa, D., Diana, A.S., Barry, C., Barbarese, E., Carson, J. H.** (1997) Transport and Localization elements in myelin basic protein mRNA. *J. Cell Biol.* 138(5): 1077-1087
- Alami-Durante, H.** (1990) Growth of organs and tissues in carp (*Cyprinus carpio* L.) larvae. *Grow. Dev. Aging* 54: 109-116
- Alami-Durante, H., Bergot, P., Rouel, M., Goldspink, G.** (2000) Effects of environmental temperature on the development of the myotomal white muscle in larval carp (*Cyprinus carpio* L.). *J. Exp. Biol.* 203: 3675-3688
- Alami-Durante, H., Fauconneau, B., Rouel, M., Escaffre, A.M., Bergot, P.** (1997) Growth and multiplication of white skeletal muscle fibres in carp larvae in relation to somatic growth rate. *J. Fish Biol.* 50: 1285-1302
- Alami-Durante, E., Rouel, M., Kentouri, M.** (2006) New insights into temperature-induced white muscle growth plasticity during *Dicentrarchus labrax* early life: a developmental and allometric study. *Marin. Biol.* 149: 1551-1565
- Alami-Durante, E., Olive, N., Rouel, M.** (2007) Early thermal history significantly affects the seasonal hyperplastic process occurring in the myotomal white muscle of *Dicentrarchus labrax* juveniles. *Cell Tissue Res.* 327: 553 - 570
- Alami-Durante, H., Médale, F., Cluzeaud, M., Kaushik, S.J.** (2010a) Skeletal muscle growth dynamics and expression of related genes in white and red muscles of rainbow trout fed diets with graded levels of a mixture of plant protein sources as substitutes for fishmeal. *Aquacult.* 303: 50-58
- Alami-Durante, H., Wrutniak-Cabello, C., Kaushik, S.J., Médale, F.** (2010b) Skeletal muscle cellularity and expression of myogenic regulatory factors and myosin heavy chains in rainbow trout (*Oncorhynchus mykiss*): Effects of changes in dietary plant protein sources and amino acid profiles. *Comp. Biochem. Physiol. Part A* 156: 561-568
- Alonso, C.R.** (2012) A complex 'mRNA degradation code' controls gene expression during animal development. *Trend. Genet.* 28(2): 78-88
- Allendorf, F.W., Utter, F.M.** (1973) Gene duplication within the family salmonidae: disomic inheritance of two loci reported to be tetrasomic in rainbow trout. *Genet.* 4: 647-654
- Almuly, R., Cavari, B., Ferstman, H., Kolodny, O., Funkenstein, B.** (2000) Genomic structure and sequence of the gilthead seabream (*Sparus aurata*) growth hormone-encoding gene: identification of minisatellite polymorphism in intron I. *Genom.* 43: 836-845
- Almuly, R., Poleg-Danin, Y., Gorshkov, S., Gorshkova, G., Rapoport, B., Soller, M., Kashi, Y., Funkenstein, B.** (2005) Characterization of the 5' flanking region of the growth hormone gene of the marine teleost, gilthead sea bream (*Sparus aurata*): analysis of a polymorphic microsatellite in the proximal promoter. *Fish. Scienc.* 71: 479-490
- Almuly, R., Skopal, T., Funkenstein, B.** (2008) Regulatory regions in the promoter and first intron of *Sparus aurata* growth hormone gene: Repression of gene activity by a polymorphic minisatellite. *Comp. Biochem. Physiol. D* 3: 43 - 50
- Amthor, H., Nicholas, G., McKinnell, I., Kemp, C.F., Sharma, M., Kambadur, R., Patel, K.** (2004) Follistatin complexes myostatin and antagonises myostatin-mediated inhibition of myogenesis. *Dev. Biol.* 270(1): 19-30
- Andrade, C., Nogueira, N., Silva, P., Dinis, M.T., Narciso, L.** (2012) Mesocosm hatcheries using semi-intensive methodologies and species diversification in aquaculture. *J. Agricult. Scienc. Techn.* B(2): 428-437

**Σφάλμα! Χρησιμοποιήστε την καρτέλα "Κεντρική σελίδα", για να εφαρμόσετε το**

**Bibliography στο κείμενο που θέλετε να εμφανίζεται εδώ.**

- 
- Andreassi, C., Riccio, A.** (2009) To localize or not to localize: mRNA fate is in 3'UTR ends. *Trends Cell Biol.* 19(9): 465-474
- Artaza, J.N., Bhasin, S., Mallidis, C., Taylor, W., Ma, K., Gonzalez-Cadavid, N.** (2002) Endogenous expression and localization of myostatin and its relation to myosin heavy chain distribution in C2C12 skeletal muscle cells. *J. Cell Physiol.* 190: 170-179
- Arumugam, K., Wang, Y., Hardy, L.L., MacNicol, M.C., MacNicol, A.M., Embo, J.** (2010) Enforcing temporal control of maternal mRNA translation during oocyte cell-cycle progression. *EMBO J.* 29(2): 387-397
- Baardvik, B.M., Jobling, M.S.** (1990) Effect of size-sorting on biomass gain and individual growth rates in Arctic charr, *Salvelinus alpinus* L. *Aquacult.* 90: 11-16
- Bailey, L.A., Hatton, D., Field, R., Dickson, A.J.** (2012) Determination of Chinese hamster ovary cell line stability and recombinant antibody expression during long-term culture. *Biotechnol. Bioeng.* 109(8): 2093-2103
- Barki, A., Haepaz, S., Hulata, G., Karpus, I.** (2000) Effects of larger fish and size grading on growth and size variation in fingerling silver perch. *Aquacult. Internat.* 8: 391-401
- Bashirullah, A., Halsell, S.R., Cooperstock, R.L., Kloc, M., Karaiskakis, M., Fisher, W.W., Fu, W., Hamilton, J.K., Etkin, I.D., Lipshitz, H.D.** (1999) Joint action of two RNA degradation pathways controls the timing of maternal transcript elimination at the midblastula transition in *Drosophila melanogaster*. *EMBO J.* 18(9): 2610-2620
- Beaudoing, E., Freier, S., Wyatt, J.R., Claverie, J.M., Gautheret, D.** (2000) Patterns of variant polyadenylation signal usage in human genes. *Genom. Res.* 10(7): 1001-1010
- Beckman, B.R.** (2011) Perspectives on concordant and discordant relations between insulin-like growth factor 1 (IGF1) and growth in fishes. *Gener. Comp. Endocrinol.* 170: 233-252
- Benedito-Palos, L., Saera-Vila, A., Calduch-Giner, J.A., Kaushik, S., Pérez-Sánchez, J.** (2007) Combined replacement of fish meal and oil in practical diets for fastgrowing juveniles of gilthead sea bream (*Sparus aurata* L.): Networking of systemic and local components of GH/IGF axis. *Aquacult.* 267: 199-212
- Benetti, D.D.** (2001) Mesocosm systems for semi-intensive larval rearing of marine fish. *Advoc.* 17-18
- Benhaïm, D., Péan, S., Brisset, B., Leguay, D., Bégout, M.L., Chatain, B.** (2011) Effect of size grading on sea bass (*Dicentrarchus labrax*) juvenile self-feeding behaviour, social structure and culture performance. *Aquat. Living Resour.* 24: 391-402
- Berg, J.M., Tymoczko, J.L., Stryer, L.** (2002) *Biochemistry*, 5th edition, Ed. by W.H. Freeman
- Bermejo-Nogales, A., Saera-Vila, A., Calduch-Giner, J.A., Navarro, J.C., Sitjà-Bobadilla, A., Pérez-Sánchez, J.** (2007) Differential metabolic and gene expression profile of juvenile common dentex (*Dentex dentex* L.) and gilthead sea bream (*Sparus aurata* L.) in relation to redox homeostasis. *Aquacult.* 267: 213 - 224
- Björnsson, B.T., Johansson, V., Benedet, S., Eir Einarsdottir, I., Hildahl, J., Agustsson, T., Jónsson, E.** (2002) Growth hormone endocrinology of salmonids: regulatory mechanisms and mode of action. *Fish Physiol. Biochem.* 27: 227-242
- Blais, A., Tsikitis, M., Acosta-Alvear, D., Sharan, R., Kluger, Y., Dynlacht, D.** (2005) An initial blueprint for myogenic differentiation. *Genes Dev.* 19: 553-569
- Boglione, C., Gagliardi, F., Scardi, M.D., Cataudella, S.** (2001) Skeletal descriptors and quality assessment in larvae and post-larvae of wild-caught and hatchery-reared gilthead sea bream (*Sparus aurata* L. 1758). *Aquacult.* 192: 1-22
- Bone, Q.** (1978) Locomotor muscle 7: 361-424. In *Fish Physiology*. Academic Press
- Bone, Q., Marshall, N.B., Blaxter, J.H.S.** (1995) *Biology of fishes*. Taylor & Francis
- Borrell, Y.J., Gallego, V., García-Fernández, C., Mazzeo, I., Pérez, L., Asturiano, J.F., Carleos, C.E., Vázquez, E., Sánchez, J.A., Blanco, G.** (2011) Assessment of parental contributions to fast - and slow - growing progenies in the sea bream *Sparus aurata* L. using a new multiplex PCR. *Aquacult.* 314: 58-65
- Boutet, S.C., Cheung, T.H., Quach, N.L., Liu, L., Prescott, S.L., Edalati, A., Iori, K., Rando, T.A.** (2012) Alternative polyadenylation mediates microRNA regulation of muscle stem cell function. *Cell Stem Cell* 10: 327-336
- Bower, N.I., Xuejun, L., Taylor, R.G., Johnston, I.A.** (2008) Switching to fast growth: the insulin-like growth factor (IGF) system in skeletal muscle of Atlantic salmon. *J. Exp. Biol.* 211: 3859-3870

**Σφάλμα! Χρησιμοποιήστε την καρτέλα "Κεντρική σελίδα", για να εφαρμόσετε το  
Bibliography στο κείμενο που θέλετε να εμφανίζεται εδώ.**

- 
- References*
- Bower, N.I., Taylor, R.G., Johnston, I.A.** (2009) Phasing of muscle gene expression with fasting-induced recovery growth in Atlantic salmon. *Front. Zool.* 6: 18
- Bower, N.I., Johnston, I.A.** (2010) Discovery and characterization of nutritionally regulated genes associated with muscle growth in Atlantic salmon. *Physiol. Genom.* 42A: 114-130
- Bregues, M., Teixeira, D., Parker, R.** (2005) Movement of eukaryotic mRNAs between polysomes and cytoplasmic processing bodies. *Scienc.* 310(5747): 486-489
- Brooks, S., Johnston, I.A.** (1993) Influence of development and rearing temperature on the distribution, ultrastructure and myosin subunit composition of myotomal muscle-fibre types in the plaice *Pleuronectes platessa*. *Mar. Biol.* 117: 501-513
- Brzeski, V.J. and Doyle, R.W.** (1995) A test of an on-farm selection procedure for tilapia growth in Indonesia. *Aquacult.* 137: 219-230
- Budasz-Widerska, M., Jank, M., Motylt, T.** (2005) Transforming growth factor- $\beta$ 1 upregulates myostatin expression in mouse C2C12 myoblasts. *J. Physiol. Pharmacol.* 56(3): 195-214
- Buskin, J.N., Hauschka, S.D.** (1989) Identification of a myocyte nuclear factor that binds to the muscle-specific enhancer of the mouse muscle creatine kinase gene. *Mol. Cell. Biol.* 9: 2627-2640
- Calduch-Giner, J.A., Sitja-Bobadilla, A., Alvarez-Pellitero, P., Perez-Sanchez, J.** (1997) Growth hormone as an in vitro phagocyte-activating factor in the gilthead sea bream (*Sparus aurata*). *Cell Tissue Res.* 287(3): 535-40
- Calduch-Giner, J.A., Mingarro, M., Vega-Rubín de Celis, S., Boujard, D., Pérez-Sánchez, J.** (2003) Molecular cloning and characterization of gilthead sea bream (*Sparus aurata*) growth hormone receptor (GHR). Assessment of alternative splicing. *Comp. Biochem. Physiol. B Biochem. Mol. Biol.* 136(1): 1-13
- Calduch-Giner, J.A., Bermejo-Nogales, A., Benedito-Palos, L., Estensoro, I., Ballester-Lozano, G., Sitja-Bobadilla, A., Pérez-Sánchez, J.** (2013) Deep sequencing for de novo construction of a marine fish (*Sparus aurata*) transcriptome database with a large coverage of protein-coding transcripts. *BMC Genom.* 14: 178
- Calvo, S.E., Pagliarini, D.J., Mooth, V.K.** (2009) Upstream open reading frames cause widespread reduction of protein expression and are polymorphic among humans *PNAS* 106(18): 7507-7512
- Campos, C., Valente, L.M., Borges, P., Bizuayehu, T., Fernandes, J.M.** (2010) Dietary lipid levels have a remarkable impact on the expression of growth-related genes in Senegalese sole (*Solea senegalensis* Kaup). *J. Exp. Biol.* 213: 200-209
- Capilla, E., Teles-García, A., Acerete, L., Navarro, I., Gutiérrez, J.** (2011) Insulin and IGF-I effects on the proliferation of an osteoblast primary culture from sea bream (*Sparus aurata*). *Gener. Comp. Endocrinol.* 172(1): 107-114
- Castillo, J., Codina, M., Martinez, M.L., Navarro, I., Gutierrez, J.** (2004) Metabolic and mitogenic effects of IGF-I and insulin on muscle cells of rainbow trout. *Am. J. Physiol. Regul. Integr. Comp. Physiol.* 286, R935-R941
- Cao, Y., Kumar, R.M., Penn, B.H., Berkes, C.A., Kooperberg, C., Boyer, L.A., Young, R.A., Tapscott, S.J.** (2006) Global and gene-specific analyses show distinct roles for Myod and Myog at a common set of promoters. *EMBO J* 25(3): 502-511
- Carmichael, G.J.** (1994) Effects of size-grading on variation and growth in channel catfish reared at similar densities. *J. World Aquacult. Soc.* 25: 7-24
- Cenadelli, S., Maran, V., Bongioni, G., Fusetti, L., Parma, P., Aleandri, R.** (2007) Identification of nuclear SNPs in gilthead seabream. *J. Fish Biol.* 70: 399-405
- Chauvigné, F., Ralliere, C., Cauty, C., Rescan, P.Y.** (2006) In situ hybridisation of a large repertoire of muscle-specific transcripts in fish larvae: the new superficial slow-twitch fibres exhibit characteristics of fast-twitch differentiation. *J. Exp. Biol.* 209: 372-379
- Chen, T.T., Kight, K., Lin, C.M., Powers, D.A., Hayat, M., Chatakondi, N., Ramboux, A.C., Duncan, P.L., Dunham, R.A.** (1993) Expression and inheritance of RSVLTR-rtGH1 complementary DNA in the transgenic common carp, *Cyprinus carpio*. *Mol. Mar. Biol. Biotechnol.* 2(2): 88-95

- 
- Chen, J.F., Mandel, E.M., Thomson, J.M., Wu, Q., Callis, T.E., et al. (2006) The role of microRNA-1 and microRNA-133 in skeletal muscle proliferation and differentiation. *Nat. Genet.* 38: 228-233
- Chen, J.F., Tao, Y., Li, J., Deng, Z., Yan, Z., et al. (2010) MicroRNA-1 and microRNA-206 regulate skeletal muscle satellite cell proliferation and differentiation by repressing Pax7. *J. Cell Biol.* 190: 867-879
- Clemmons, D.R. (2009) Role of IGF-I in skeletal muscle mass maintenance. *Trends Endocrinol. Metab.* 20(7): 349-356
- Çoban, D., Kamaci, H.O., Suzer, C., Saka, Ş., Firat, K. (2009) Allometric growth in hatchery-reared gilthead seabream. *North Amer. J. Aquacult.* 71(3): 189-196
- Codina, M., García de la serrana, D., Sánchez-Gurmaches, J., Montserrat, N., Chistyakova, O., Navarro, I., Gutiérrez, J. (2008) Metabolic and mitogenic effects of IGF-II in rainbow trout (*Oncorhynchus mykiss*) myocytes in culture and the role of IGF-II in the PI3K/Akt and MAPK signalling pathways. *Gener. Comp. Endocrinol.* 157: 116-124
- Colgan, D.F., Manley, J.L. (1997) Mechanism and regulation of mRNA polyadenylation. *Genes Dev.* 11: 2755-2766
- Company, R., Caldach-Giner, J.A., Kaushik, S., Pérez-Sánchez, J. (1999) Growth performance and adiposity in gilthead sea bream (*Sparus aurata*): risks and benefits of high energy diets. *Aquacult.* 171: 279 - 292
- Company, R., Astola, A., Pendón, C., Valdivia, M.M., Pérez-Sánchez, J. (2001) Somatotropic regulation of fish growth and adiposity: growth hormone (GH) and somatolactin (SL) relationship. *Comp. Biochem. Physiol.* 130C: 435-445
- Conti, E., Izaurrealde, E., (2005) Nonsense-mediated mRNA decay: molecular insights and mechanistic variations across species. *Curr. Opin. Cell Biol.* 17: 316-325
- Coolican, S.A., Samuel, D.S., Ewton, D.Z., McWade, F.J., Florini, J.R. (1997) The mitogenic and myogenic actions of insulin-like growth factors utilize distinct signaling pathways. *J. Biol. Chem.* 272: 6653-6662
- Crockford, T., Johnston, I.A. (1990) Temperature acclimation and the expression of contractile protein isoforms in the skeletal muscles of the common carp (*Cyprinus carpio* L.). *J. Comp. Physiol. B* 160(1): 23-30
- Crockford, T., Johnston, I.A. (1993) Developmental changes in the composition of myofibrillar proteins in the swimming muscles of Atlantic herring, *Clupea harengus*. *Mar. Biol.* 115: 15-22
- Cserjesi, P., Olson, E.N. (1991) Myogenin induces the myocyte-specific enhancer-binding factor MEF-2 independently of other muscle-specific gene products. *Mol. Cell Biol.* 11: 4854-4862
- Dahanukar, A., Wharton, R.P. (1996) The Nanos gradient in *Drosophila* embryos is generated by translational regulation. *Genes Dev.* 10: 2610-2620
- Darias, M.J., Zambonino-Infante, J.L., Hugot, K., Cahu, C.L., Mazurais, D. (2008) Gene expression patterns during the larval development of European sea bass (*Dicentrarchus labrax*) by microarray analysis. *Mar. Biotechnol.* 10: 416-428
- Dedieu, S., Mazères, G., Cottin, P., Brustis, J.J. (2002) Involvement of myogenic regulator factors during fusion in the cell line C2C12. *Int. J. Dev. Biol.* 46: 235-241
- Del Coco, L., Papadia, P., De Pascali, S.A., Bressani, G., Storelli, C., Zonno, V., Fanizzi, F.P. (2009) Comparison among different gilthead sea bream (*Sparus aurata*) farming systems: Activity of intestinal and hepatic enzymes and <sup>13</sup>C-NMR analysis of lipids. *Nutr.* 1: 291-301
- Devlin, R.H., Yesaki, T.Y., Donaldson, E.M., Du, S.J., Hew, C.L. (1995) Production of germline transgenic Pacific salmonids with dramatically increased growth performance. *Canadian J. Fish. Aquat. Scienc.* 52: 1376-1384
- Devlin, R.H. (1997) Transgenic salmonids: 105-117. In *Transgenic animals: Generation and Use* Ed. by L.M. Houdebine, Harwood Academic Publishers
- Devlin, R.H., Sundström, L.F., Muir, W.M. (2006) Interface of biotechnology and ecology for environmental risk assessments of transgenic fish. *Trends Biotechnol.* 24: 89-97
- Divanach, P., Kentouri, M. (2000) Hatchery techniques for specific diversification in Mediterranean finfish larviculture, in: *Recent advance. Mediter. aquacult. finfish species diversific.* Zaragoza : CIHEAM, 2000. pp: 75-87. (Cahiers Options Méditerranéennes; n. 47). Seminar of the CIHEAM Network on Technology of Aquaculture in the Mediterranean on "Recent advances in Mediterranean aquaculture finfish species diversification", 1999/05/24-28, Zaragoza (Spain).



- 
- Duguay, S. J., Zhang-Lai, J., Steiner, D. F., Funkenstein, B., and Chan, S. J. (1996) Developmental and tissue-regulated expression of IGF-I and IGF-II mRNAs in *Sparus aurata*. *J. Mol. Endocrinol.* 16: 123-132
- Ebert, A.M., McAnelly, C.A., Srinivasan, A., Lockridge Mueller, R., Garrity, D.B., Garrity, D.M. (2008) The calcium channel  $\beta 2$  (CACNB2) subunit repertoire in teleosts. *BMC Mol. Biol.* 9:38 *References*
- Edmondson, D.G., Cheng, T.C., Cserjesi, P., Chakraborty, T., Olson, E.N. (1992) Analysis of the myogenin promoter reveals an indirect pathway for positive autoregulation mediated by the muscle-specific enhancer factor MEF-2. *Mol. Cell. Biol.* 12: 3665-3677
- Eisen, M. (2002) Cluster 3.0 manual. Stanford University 1998-1999
- Emerson, C.P. Jr., Bernstein, S.I. (1987) Molecular genetics of myosin. *Annu. Rev. Biochem.* 56: 695-726
- Ennion, S., Gauvry, L., Butterworth, P., Goldspink, G. (1995) Small-diameter white myotomal muscle fibres associated with growth hyperplasia in carp (*Cyprinus carpio*) express a distinct myosin heavy chain gene. *J. Exp. Biol.* 198: 1603-1611
- Ennion, S., Wilkes, D., Gauvry, L., Alami-Durante, H., Goldspink, G. (1999) Identification and expression analysis of two developmentally regulated myosin heavy chain gene transcripts in carp (*Cyprinus carpio*). *J. Exp. Biol.* 202(9): 1081-1090
- Fabian, M.R., Sonenberg, N., Filipowicz, W. (2010) Regulation of mRNA translation and stability by microRNAs. *Annu. Rev. Biochem.* 79: 351-379
- FEAP Annual Report (2011)  
[http://issuu.com/designtactics/docs/61910\\_10\\_feap\\_annual\\_report\\_2011\\_web\\_2?mode=embed&layout=http%3A%2F%2Fskin.issuu.com%2Fv%2Fcolor%2Flayout.xml&background-color=2A5083&showFlipBtn=true](http://issuu.com/designtactics/docs/61910_10_feap_annual_report_2011_web_2?mode=embed&layout=http%3A%2F%2Fskin.issuu.com%2Fv%2Fcolor%2Flayout.xml&background-color=2A5083&showFlipBtn=true)
- Federation of Greek Mariculture (2008), <http://www.imbc.gr/fgm/en/activ/index.html>
- Felsenstein, J. (1985) Confidence limits on phylogenies: An approach using the bootstrap. *Evol.* 39: 783-791
- Fernald, R.D. (1990) Teleost vision: seeing while growing. *J. Exp. Zool. Suppl.* 5: 167-180
- Fernández, I., Darias, M., Andree, K.B., Mazurais, D., Zambonino-Infante, J.L., Gisbert, E. (2011) Coordinated gene expression during gilthead sea bream skeletogenesis and its disruption by nutritional hypervitaminosis A. *BMC Dev. Biol.* 11: 7
- Ferraresso, S., Vitulo, N., Mininni, A.N., Romualdi, C., Cardazzo, B., Negrisolo, E., Reinhardt, R., Canario, A.V.M., Patarnello, T., Bargelloni, L. (2008) Development and validation of a gene expression oligo microarray for the gilthead sea bream (*Sparus aurata*). *BMC Genom.* 9: 580
- Ferri, P., Barbieri, E., Burattini, S., Guescini, M., D'Emilio, A., Biagiotti, L., Del Grande, P., De Luca, A., Stocchi, V., Falcieri, E. (2009) Expression and sub-localization of myogenic regulatory factors during the differentiation of skeletal muscle C2C12 myoblasts. *J. Cell Biochem.* 108: 1302-1317
- Filipowicz, W., Bhattacharyya, S.N., Sonenberg, N. (2008) Mechanisms of post-transcriptional regulation by microRNAs: are the answers in sight? *Nat. Rev. Genet.* 9: 102-114
- Flos, R., Reig, L., Oca, J., Ginovart, M. (2002) Influence of marketing and different land-based systems on gilthead sea bream (*Sparus aurata*) quality. *Aquacult. Internat.* 10(3): 189-206
- Focant, B., Huriaux, F., Vandewalle, P., Castelli, M., Goessens, G. (1992) Myosin, parvalbumin and myofibril expression in barbel (*Barbus barbus* L.) lateral white muscle during development. *Fish Physiol. Biochem.* 10: 133-143
- Focant, B., Vandewalle, P., Huriaux, F. (1994) Myosin polymorphism during the development of the trout, *Oncorhynchus mykiss*. *Arch. Int. Physiol. Biochim. Biophys.* 102: B54
- Focant, B., Collin, S., Vandewalle, P., Huriaux, F. (2000) Expression of myofibrillar proteins and parvalbumin isoforms in white muscle of the developing turbot *Scophthalmus Maximus* (Pisces, Pleuronectiformes). *Basic Appl. Myol.* 10(6): 269-278
- Focant, B., Vandewalle, R., Huriaux, F. (2003) Expression of myofibrillar proteins and parvalbumin isoforms during the development of a flatfish, the common sole *Solea solea*: comparison with the turbot *Scophthalmus maximus*. *Comp. Biochem. Physiol. Part B: Biochem. Mol. Biol.* 135: 493-502

- 
- Force, A., Lynch, M., Pickett, F.B., Amores, A., Yan, Y.L., Postlethwait, J. (1999) Preservation of duplicate genes by complementary. *Degener. Mutat. Genet.* 151: 1531-1545
- Franch, R., Louro, B., Tsalavouta, M., Chatziplis, D., Tsigenopoulos, C.S., Sarropoulou, E., Antonello, J., Magoulas, A., Mylonas, C.C., Babbucci, M., Patarnello, T., Power, D.M., Kotoulas, G., Bargelloni, L. (2006) A genetic linkage map of the hermaphrodite teleost fish *Sparus aurata* L. *Genet.* 174: 851-861
- Fuentes, E.N., Valdés, J.A., Molina, A., Björnsson, B.T. (2013) Regulation of skeletal muscle growth in fish by the growth hormone – Insulin-like growth factor system. *Gener. Comp. Endocrinol.*, in press
- Funkenstein, B., Skopal, T., Rapoport, B., Rebhan, Y., Du, S.J., Radaelli, G. (2007) Characterization and functional analysis of the 5' flanking region of myosin light chain-2 gene expressed in white muscle of the gilthead sea bream (*Sparus aurata*). *Comp. Biochem. Physiol. Part D2*: 187-199
- Funkenstein, B., Rebhan, Y. (2007) Expression, purification, renaturation and activation of fish myostatin expressed in *Escherichia coli*: facilitation of refolding and activity inhibition by myostatin prodomain. *Protein. Expr. Purif.* 54: 54-65
- Funkenstein, B., Tandler, A., Cavari, B. (1992) Developmental expression of the growth hormone gene in the gilthead sea bream *Sparus aurata*. *Molec. Cell. Endocrinol.* 87: R7-R9
- Funkenstein, B., Cohen, I. (1996) Ontogeny of growth hormone protein and mRNA in the gilthead sea bream *Sparus aurata*. *Growth Regul.* 6: 16-21
- Funkenstein, B., Almuly, R., and Chan, S. J. (1997) Localization of IGF-I and IGF-I receptor mRNA in *Sparus aurata* larvae. *Gener. Comp. Endocrinol.* 107: 291-303
- Funkenstein, B., Skopal, T., Rapoport, B., Rebhan, Y., Du, S.J., Radaelli, G. (2007) Characterization and functional analysis of the 5' flanking region of myosin light chain-2 gene expressed in white muscle of the gilthead sea bream (*Sparus aurata*) *Comp. Biochem. Physiol., Part D 2*: 187-199
- Funkenstein, B., Rebhan, Y., Skopal, T. (2009) Molecular cloning and characterization of follistatin in the gilthead sea bream, *Sparus aurata*. *Mol. Biol. Rep.* 36(3): 501-511
- Gahr, S.A., Vallejo, R.L., Weber, G.M., Shepherd, B.S., Silverstein, J.T. & Rexroad III, C.E. (2008) Effects of short-term growth hormone treatment on liver and muscle transcriptomes in rainbow trout (*Oncorhynchus mykiss*). *Physiol. Genom.* 32: 380-392
- Galloway, T.F., Kjorsvik, E., Kryvi, H. (1999) Muscle growth and development in Atlantic cod larvae (*Gadus morhua* L.) related to different somatic growth rates. *J. Exp. Biol.* 202: 2111-2120
- Galloway, T.F., Bardal, T., Kvam, S.N., Dahle, S.W., Nesse, G., Randø, M., Kjorsvik, E., Andersen, O. (2006) Somite formation and expression of MyoD, myogenin and myosin in Atlantic halibut (*Hippoglossus hippoglossus* L.) embryos incubated at different temperatures: transient asymmetric expression of MyoD. *J. Exp. Biol.* 209: 2432-2441
- Garcia de la serrana, D., Estévez, A., Andree Ian A Johnston, K. (2012) Fast skeletal muscle transcriptome of the gilthead sea bream (*Sparus aurata*) determined by next generation sequencing. *BMC Genom.* 13: 181
- Garneau, N.L., Wilusz, J., Wilusz, S.J. (2007) The highways and byways of mRNA decay. *Nat. Rev. Mol. Cell Biol.* 8: 113-126
- Gauthier, G.F., Lowey, S., Benfield, P. A., Hobbs, A. W. (1982) Distribution and properties of myosin isozymes in developing avian and mammalian skeletal muscle fibres. *J. Cell Biol.* 92: 472-484
- Gerlach, G.F., Turay, L., Malik, K.T.A., Lida, J., Scutt, A., Goldspink, G. (1990) Mechanisms of temperature acclimation in the carp: a molecular biological approach. *Am. J. Physiol.* 259: R237-R244
- Ghanawi, J., Saoud, I.P., Shalaby, S.M. (2010) Effect of size sorting on growth performance of juvenile spinefoot rabbitfish, *Siganus rivulatus*. *J. World Aquacult. Soc.* 41(4): 565-573
- Di Giammartino, D.C., Nishida, K., Manley, J.L. (2011) Mechanisms and consequences of alternative polyadenylation. *Mol. Cell* 43(16): 853-866
- Glass, D.J. (2003) Molecular mechanisms modulating muscle mass. *Trends Mol. Med.* 9(8): 344-350
- Glass, D.J. (2005) Skeletal muscle hypertrophy and atrophy signaling pathways. *Int. J. Biochem. Cell Biol.* 37(10): 1974-1984
- Goldspink, G. (1972) Postembryonic growth and differentiation of striated muscle. In *The structure and function of muscle*, Vol. 1, 2nd Ed., 179-236. Academic Press

**Σφάλμα! Χρησιμοποιήστε την καρτέλα "Κεντρική σελίδα", για να εφαρμόσετε το**

**Bibliography στο κείμενο που θέλετε να εμφανίζεται εδώ.**

- 
- Gómez-Requeni, P., Mingarro, M., Calduch-Giner, J.A., Méedale, F., Martin, S.A.M., Houlihan, D.F., Kaushik, S., Pérez-Sánchez, J.** (2004) Protein growth performance, amino acid utilisation and somatotropic axis responsiveness to fish meal replacement by plant protein sources in gilthead sea bream (*Sparus aurata*). *Aquacult.* 232: 493-510
- Goodarzi, H., Najafabadi, H.S., Oikonomou, P., Greco, T.M., Fish, L., Salavati, R., Cristea, I.M., Tavazoie, S.** (2012) Systematic discovery of structural elements governing stability of mammalian messenger RNAs. *Nat. 485(7397): 264-268* References
- Goode, D.K., Callaway, H.A., Cerda, G.A., Lewis, K.E., Elgar, G.** (2011) Minor change, major difference: divergent functions of highly conserved cis-regulatory elements subsequent to whole genome duplication events. *Dev.* 138(5): 879-884
- Gossett, L.A., Kelvin, D.J., Sternberg, E.A., Olson, E.N.** (1989) A new myocytes specific enhancer-binding factor that recognizes a conserved element associated with multiple muscle-specific genes. *Mol. Cell. Biol.* 9: 5022-5033
- Groves, J.A., C., Hammond, L., Hughes, S.M.** (2005) Fgf8 drives myogenic progression of a novel lateral fast muscle fibre population in zebrafish. *Dev.* 132: 4211-4222
- Gunnes, K.** (1976) Effect of size grading young Atlantic salmon (*Salmo salar*) on subsequent growth. *Aquacult.* 9: 381-386
- Ha, I., Wightman, B., Ruvkun, G.** (1996) A bulged lin-4/lin-14 RNA duplex is sufficient for *Caenorhabditis elegans* lin-14 temporal gradient formation. *Genes Dev.* 10: 3041-3050
- De Heredia, M.L., Jansen, R.P.** (2003) mRNA localization and the cytoskeleton. *Curr. Opin. Cell Biol.* 16: 1-6
- Herrero-Turrión, M.J., Rodríguez, R.E., Velasco, A., González-Sarmiento, R., Aijón, J., Lara, J.M.** (2003) Growth hormone expression in ontogenic development in gilthead sea bream. *Cell Tissue Res.* 313: 81-92
- Hevroy, E.M., Jordal, A.E.O., Hordvik, I., Espe, M., Hemre, G.I., Olsvik, P.A.** (2006) Myosin heavy chain mRNA expression correlates higher with muscle protein accretion than growth in Atlantic salmon, *Salmo salar*. *Aquacult.* 252: 453-461
- Hill, J.A., Kiessling, A., Devlin, R.H.** (2000) Coho salmon (*Oncorhynchus kisutch*) transgenic for a growth hormone gene construct exhibit increased rates of muscle hyperplasia and detectable levels of differential gene expression. *Can. J. Fish. Aquat. Scienc.* 57: 939-950
- Hirayama, Y., Kobiyama, A., Ochiai, Y., Watabe, S.** (1998) Two types of mRNA encoding regulatory light chain in carp fast skeletal muscle differ in their 3' non-coding regions and expression patterns following temperature acclimation. *J. Exp. Biol.* 201: 2815-2820
- Holland, L.Z., Pace, D., Blink, M., Kene, M. and Holland, N.D.** (1995) Sequence and expression of amphioxus alkali myosin light chain (amphiMLC-alk) throughout development: implications for vertebrate myogenesis. *Dev. Biol.* 171: 665-676
- Hollway, G.E., Bryson-Richardson, R.J., Berger, S., Cole, N.J., Hall, T.E., Currie, P.D.** (2007) Whole-somite rotation generates muscle progenitor cell compartments in the developing zebrafish embryo. *Dev. Cell* 12(2): 207-219
- Huang, T.H., Zhu, M.J., Li, X.Y., Zhao, S.H.** (2008) Discovery of porcine microRNAs and profiling from skeletal muscle tissues during development. *PLoS One* 3: e3225
- Huntingford, F.A., Metcalfe, N.B., Thorpe, J.E., Graham, W.D., Adams, C. E.** (1990) Social dominance and body size in Atlantic salmon parr, *Salmo salar* L. *J. Fish Biol.* 36: 877-881
- Huriaux, F., Vandewalle, P., Baras, E., Legendre, M., Focant, B.** (1999) Myofibrillar proteins in white muscle of the developing African catfish *Heterobranchus longifilis* (Siluriforms, Clariidae). *Fish Physiol. Biochem.* 21: 287-301
- Hussenot, J. M. E.** (2003) Emerging effluent management strategies in marine fish-culture farms located in European coastal wetlands. *Aquacult.* 226(1-4): 113-128
- Huxley, A.F.** (2000) Mechanics and models of the myosin motor. *Phil. Trans. R. Soc. Lond. B Biol. Scienc.* 355: 433-440
- Imai, J., Hirayama, Y., Kikuchi, K., Kakinuma, M., Watabe, S.** (1997) cDNA cloning of myosin heavy chain isoforms from carp fast skeletal muscle and their gene expression associated with temperature acclimation. *J. Exp. Biol.* 200(1): 27-34

**Σφάλμα! Χρησιμοποιήστε την καρτέλα "Κεντρική σελίδα", για να εφαρμόσετε το**

**Bibliography στο κείμενο που θέλετε να εμφανίζεται εδώ.**

- 
- Ishibashi, J., Perry, R.L., Asakura, A., Rudnicki, M.A.** (2005) MyoD induces myogenic differentiation through cooperation of its NH<sub>2</sub>- and COOH-terminal regions. *J. Cell Biol.* 171(3): 471–482
- Izumo, S., Nadal-Ginard, B., Mahdavi, V.** (1986) All members of MHC multigene family respond to thyroid hormone in a highly tissue-specific manner. *Scienc.* 231: 597–600
- Jensen, G. L.** (1990) Sorting and grading warmwater fish. *Southern Regional Aquaculture Center Publication No. 391*, Stoneville, Mississippi
- Ji, Z., Lee, J.Y., Pan, Z., Tian, B.** (2009) Progressive lengthening of 3' untranslated regions of mRNAs by alternative polyadenylation during mouse embryonic development. *PNAS* 106 (17): 7028–7033 *References*
- Jiménez-Amilburu, V., Salmerón, C., Codina, M., Navarro, I., Capilla, E., Gutiérrez, J.** (2013) Insulin-like growth factors effects on the expression of myogenic regulatory factors in gilthead sea bream muscle cells. *Gener. Comp. Endocrinol.* 188: 151–158
- Jimenez-Delgado, S., Pascual-Anaya, J., Garcia-Fernández, J.** (2009) Implications of duplicated *cis*-regulatory elements in the evolution of metazoans: the DDI model or how simplicity begets novelty. *Brief. Funct. Genomic. Proteomic.* 8: 266-275
- Jobling, M., Reinsnes, T.G.** (1987) Effect of sorting on size-frequency distributions and growth of Arctic charr, *Salvelinus alpinus* L. *Aquacult.* 60: 27-31
- Johnston, I.A., Vieira, V.L.A., Abercrombie, M.** (1995) Temperature and myogenesis in embryos of the Atlantic herring *Clupea harengus*. *J. Exp. Biol.* 198: 1389–1403
- Johnston, I.A., Cole, N., Viera, V.L.A., Davidsont, I.** (1997) Temperature and developmental plasticity of muscle phenotype in herring larvae. *J. Exp. Biol.* 200: 849–868
- Johnston, I.A., Cole, N.J., Abercromby, M., Vieira, V.L.A.** (1998) Embryonic temperature modulates muscle growth characteristics in larval and juvenile herring. *J. Exp. Biol.* 201: 623–646
- Johnston, I. A.** (1999) Muscle development and growth: potential implications for flesh quality in fish. *Aquacult.* 177: 99-115
- Johnston, I.A., Mclay, H.A., Abercromby, M., Robins, D.** (2000) Early thermal experience has different effects on growth and muscle fibre recruitment in spring- and autumn-running Atlantic salmon populations. *J. Exp. Biol.* 203: 2553–2564
- Johnston, I.A., Manthri, S., Smart, A., Campbell, P., Nickell, D., Alderson, R.** (2003) Plasticity of muscle fibre number in seawater stages of Atlantic salmon in response to photoperiod manipulation. *J. Exp. Biol.* 206: 3425-3435
- Johnston, I.A., Hall, T.E.** (2004) Mechanisms of muscle development and responses to temperature change in fish larvae. *Am Fisheries Soc. Symp.* 40: 85–116
- Johnston, I. A.** (2006) Environment and plasticity of myogenesis in teleost fish. *J. Exp. Biol.* 209: 2249-2264
- Johnston, I.A., Macqueen, D.J., Watabe, S.** (2008) Molecular biotechnology of development and growth in fish muscle. *Fisher. Global Welfar. Environm.* 241–262, 5th World Fisher. Congr.
- Johnston, I.A., Lee, H.T., Macqueen, D.J., Paranthaman, K., Kawashima, C., Anwar, A., Kinghorn, J.R., Dalmay, T.** (2009) Embryonic temperature affects muscle fibre recruitment in adult zebrafish: genome-wide changes in gene and microRNA expression associated with the transition from hyperplastic to hypertrophic growth phenotypes. *J. Exp. Biol.* 212(12): 1781-1793
- Johnston, I.A., Bower, N.I., Macqueen, D.J.** (2011) Growth and the regulation of myotomal muscle mass in teleost fish. *J. Exp. Biol.* 214: 1617-1628
- Ikeda, D., Ono, Y., Snell, P., Edwards, Y.J., Elgar, G., Watabe, S.** (2007) Divergent evolution of the myosin heavy chain gene family in fish and tetrapods: evidence from comparative genomic analysis. *Physiol. Genom.* 32(1): 1-15
- Kamstra, A.** (1993) The effect of size grading on individual growth in eel, *Anguilla anguilla*, measured by individual marking. *Aquacult.* 112: 67–77
- Kasahara, M., Naruse, K., Sasaki, S., Nakatani, Y., Qu, W., Ahsan, B., Yamada, T., Nagayasu, Y., Doi, K., Kasai, Y., Jindo, T., Kobayashi, D., Shimada, A., Toyoda, A., Kuroki, Y., Fujiyama, A., Sasaki, T., Shimizu, A., Asakawa, S., Shimizu, N., Hashimoto, S., Yang, J., Lee, Y., Matsushima, K., Sugano, S., Sakaizumi, M., Narita, T., Ohishi, K., Haga, S., Ohta, F., Nomoto, H., Nogata, K., Morishita, T., Endo, T., Shin, I.T., Takeda, H., Morishita, S., Kohara, Y.** (2007) The medaka draft genome and insights into vertebrate genome evolution. *Nat.* 447: 714–719

Σφάλμα! Χρησιμοποιήστε την καρτέλα "Κεντρική σελίδα", για να εφαρμόσετε το

*Bibliography* στο κείμενο που θέλετε να εμφανίζεται εδώ.

- 
- Kassar-Duchossoy, L., Gayraud-Morel, B., Gomés, D., Rocancourt, D., Buckingham, M., Shinin, V., Tajbakhsh, S.** (2004) Mrf4 determines skeletal muscle identity in Myf5:Myod double-mutant mice. *Nat.* 431(7007): 466-471
- Kent, WJ.** (2002) BLAT - the BLAST - like alignment tool. *Genom. Res.* 12(4): 656-664
- Kestemont, P., Jourdan, S., Houbart, M., Mélard, C., Paspatis, M., Fontaine, P., Cuvier, A., Kentouri, M., Baras, E.** (2003) Size heterogeneity, cannibalism and competition in cultured predatory fish larvae: biotic and abiotic influences. *Aquacult.* 227: 333-356
- Khemis, I.B., Gisbert, E., Alcaraz, C., Zouiten, D., Besbes, R., Zouiten, A., Masmoudi, A.S., Cahu, C.** (2012) Allometric growth patterns and development in larvae and juveniles of thick-lipped grey mullet *Chelon labrosus* reared in mesocosm conditions. *Aquacult. Res.* 1-17
- Kiessling, A., Ruohonen, K., Bjørnevik, M.** (2006) Muscle fibre growth and quality in fish. *Arch. Tierz., Dummerstorf* 49; Special Issue, 137-146
- Kim, H.H., Gorospe, M.** (2008) GU-rich RNA: expanding CUGBP1 function, broadening mRNA turnover. *Mol. Cell.* 29(2): 151-152
- Kim, T.K., Eberwine, J.H.** (2010) Mammalian cell transfection: the present and the future. *Anal. Bioanal. Chem.* 397: 3173-3178
- Kim-Ha, J., Kerr, K., Macdonald, P.M.** (1995) Translational regulation of oskar mrna by Bruno, an ovarian RNA-binding protein, is essential. *Cell* 81: 403-412
- Kiri, A., Goldspink, G.** (2002) RNA-protein interactions of the 3' untranslated regions of myosin heavy chain transcripts. *J. Muscl. Res. Cell Motil.* 23: 119-129
- Kislauskis, E.H., and Singer, R.H.** (1992) Determinants of mRNA localization. *Curr. Opin. Cell Biol.* 4: 975-978
- Knight, J.D.R., Kothary, R.** (2011) The myogenic kinome: protein kinases critical to mammalian skeletal myogenesis. *Skelet. Muscl.* 1: 29
- Koumoundouros, G., Gagliardi, F., Divanach, P., Boglione, C., Cataudella, S., Kentouri, M.** (1997) Normal and abnormal osteological development of caudal fin in *Sparus aurata* L. fry. *Aquacult.* 149: 215-226
- Koumoundouros, G., Ashton, C., Xenikoudakis, G., Giopanou, I., Georgakopoulou, E., Stickland, N.** (2009) Ontogenetic differentiation of swimming performance in Gilthead seabream (*Sparus aurata*, Linnaeus 1758) during metamorphosis. *J. Exp. Mar. Biol. Ecol.* 370: 75-81
- Krasnov, A., Teerijoki, H., Gorodilov, Y., Mölsä, H.** (2003) Cloning of rainbow trout (*Oncorhynchus mykiss*) a-actin, myosin regulatory light chain genes and the 5' -flanking region of a-tropomyosin. Functional assessment of promoters. *J. Exp. Biol.* 206: 601-608
- Kuhl, H., Sarropoulou, E., Tine, M., Kotoulas, G., Magoulas, A., Reinhardt, R.** (2011) A comparative BAC map for the gilthead sea bream (*Sparus aurata* L.). *J. Biomed. Biotechn.*: 329025
- Lal, A., Mazan-Mamczarz, K., Kawai, T., Yang, X., Martindale, J.L., Gorospe, M.** (2004) Concurrent versus individual binding of HuR and AUF1 to common labile target mRNAs. *EMBO J.* 23(15): 3092-3102
- Lambert, Y., Dutil, J.D.** (2001) Food intake and growth of adult Atlantic cod (*Gadus morhua* L.) reared under different conditions of stocking density, feeding frequency and size-grading. *Aquacult.* 192: 233-247
- Lee, R.C., Feinbaum, R.L., Ambrost, V.** (1993) The *C. elegans* heterochronic gene *lin-4* encodes small RNAs with antisense complementarity to *lin-14*. *Cell* 75: 843-854
- Lee, S.J., McPherron, A.C.** (2001) Regulation of myostatin activity and muscle growth. *PNAS* 98(16): 9306-9311
- Lee, S.Y., Kim, D.S., Nam, Y.K.** (2012) Genomic organization, intronic duplications, and promoter characteristics of the fast skeletal myosin light chain-2 gene (*mlc2f*) from Javanese ricefish *Oryzias javanicus*. *Fish Aquat. Scienc.* 15(4): 325-335
- Levine, M., Tjian, R.** (2003) Transcription regulation and animal diversity. *Nat.* 424(10): 147-151
- Li, J., Johnson, S.E.** (2006) ERK2 is required for efficient terminal differentiation of skeletal myoblasts. *Biochem. Biophys. Res. Commun.* 345: 1425-1433

- 
- Liu, H., Rodgers, N.D., Jiao, X., Kiledjian, M.** (2002) The scavenger mRNA decapping enzyme DcpS is a member of the HIT family of pyrophosphatases. *EMBO J.* 21: 4699–4708
- Louro, B., Passos, A.L.S., Souche, E.L., Tsigenopoulos, C., Beck, A., Lagnel, J., Bonhomme, F., Cancela, L., Cerdà, J., Clark, M., Lubzens, E., Magoulas, A., Planas, J.V., Volckaert, F.A.M., Reinhardt, R., Canario, A.V.M.** (2010) Gilthead sea bream (*Sparus auratus*) and European sea bass (*Dicentrarchus labrax*) expressed sequence tags: Characterization, tissue-specific expression and gene markers. *Mar. Genom.* 3: 179–191
- Lowey, S.** (1994) The structure of vertebrate muscle myosin: 485-505. In *Myology*. Ed. A.G. Engel, C. Franzini-Armstrong. McGraw- Hill Book Co
- Lutz, C.S.** (2008) Alternative polyadenylation: a twist on mRNA 3' end formation. *ACS Chem. Biol.* 3(10): 609-617
- Maccatrozzo, L., Bargelloni, L., Radaelli, G., Mascarello, F., Patarnello, T.** (2001) Characterization of the myostatin gene in the gilthead seabream (*Sparus aurata*): sequence, genomic structure, and expression pattern. *Mar. Biotechnol.* 3(3): 224-230
- Macqueen, D.J., Johnston, I.A.** (2008) An update on myod evolution in teleosts and a proposed consensus nomenclature to accommodate the tetraploidization of different vertebrate genomes. *PLoS* 3(2): e1567
- Macqueen, D.J., Robb, D., Johnston, I.A.** (2007) Temperature influences the coordinated expression of myogenic regulatory factors during embryonic myogenesis in Atlantic salmon (*Salmo salar* L.). *J. Exp. Biol.* 210(16): 2781-2794
- Maniatis, T., Fritsch, E.F., Sambrook, J.** (1982) Molecular cloning. A laboratory manual. *Cold Spring Harbor Laboratory*
- Martí-Palanca, H., Martínez-Barbera, J.P., Pendón, C., Valdivia, M.M., Pérez-Sánchez, J., Kaushik, S.** (1996) Growth hormone as a function of age and dietary protein: energy ratio in a marine teleost, the gilthead sea bream (*Sparus aurata*). *Growth Regul.* 6(4): 253-259
- Martin, K.C., Ephrussi, A.** (2009) mRNA localization: gene expression in the spatial dimension. *Cell* 136(4): 719
- Martinez, I., Christiansen, J.S., Ofstad, R., Olsen, R.L.** (1991) Comparison of myosin isoenzymes present in skeletal and cardiac muscles of the Arctic charr *Salvelinus alpinus* (L.). Sequential expression of different myosin heavy chains during development of the fast white skeletal muscle. *Eur. J. Biochem.* 195(3): 743-753
- Matzuk, M.M., Lu, N., Vogel, H., Sellheyer, K., Roop, D.R., Bradley, A.** (1995) Multiple defects and perinatal death in mice deficient in follistatin. *Nat.* 374: 360–363
- Mendez, R., Richter, J.D.** (2001) Translational control by CPEB: a means to the end. *Nat. Rev. Mol. Cell Biol.* 2: 521–529
- Mignone, F., Gissi, C., Liuni, S., Pesole, G.** (2002) Untranslated regions of mRNAs. *Genom. Biol.* 3: 3
- Mingarro, M., Vega-Rubín de Celis, S., Astola, A., Pendón, C., Valdivia, M.M., Pérez-Sánchez, J.** (2002) Endocrine mediators of seasonal growth in gilthead sea bream (*Sparus aurata*): the growth hormone and somatotactin paradigm. *Gener. Comp. Endocrinol.* 128(2): 102-111
- Mishima, Y., Abreu-Goodger, C., Staton, A.A., Stahlhut, C., Shou, C., et al.** (2009) Zebrafish miR-1 and miR-133 shape muscle gene expression and regulate sarcomeric actin organization. *Genes Dev.* 23: 619–632
- Miyamoto, S., Chiorini, J.A., Urcelay, E., Safer, B.** (1996) Regulation of gene expression for translation initiation factor eIF-2 alpha: importance of the 3' untranslated region. *Biochem J.* 315(3): 791–798
- Montserrat, N., Capilla, E., Navarro, I., Gutiérrez, J.** (2012) Metabolic effects of insulin and IGFs on gilthead sea bream (*Sparus aurata*) muscle cells. *Front. Endocrinol.* 3: 55
- Montserrat, N., Sánchez-Gurmaches, J., García de la Serrana, D., Navarro, M.I., Gutiérrez, J.** (2007) IGF-I binding and receptor signal transduction in primary cell culture of muscle cells of gilthead sea bream: changes throughout in vitro development. *Cell Tissue Res.* 330: 503–513
- de Moor, L., Richter, J.D.** (1997) The Mos pathway regulates cytoplasmic polyadenylation in *Xenopus* oocytes. *Mol. Cell. Biol.* 17: 6419–6426
- de Moor, L., Richter, J.D.** (1999) Cytoplasmic polyadenylation elements mediate masking and unmasking of cyclin B1 mRNA. *EMBO J.* 18(8): 2294–2303

**Σφάλμα! Χρησιμοποιήστε την καρτέλα "Κεντρική σελίδα", για να εφαρμόσετε το**

**Bibliography στο κείμενο που θέλετε να εμφανίζεται εδώ.**

- 
- de Moor, C.H., Meijer, H., Lissenden, S.** (2005) Mechanisms of translational control by the 3' UTR in development and differentiation. *Semin. Cell Dev. Biol.* 16: 49–58
- Moretti, A., Fernandez-Criado, M.P., Cittolin, G., Guidastrì, R.** (1999) Manual on hatchery production of seabass and gilthead seabream. *FAO*, Vol. 2, <http://www.fao.org/docrep/008/y6018e/y6018e00.HTM>
- Moriyama, S., Ayson, F.G., Kawauchi, H.** (2000) Growth regulation by insulin-like growth factor I in fish. *Bioscienc. Biotechnol. Biochem.* 64(8): 1553-1561
- Mosconi, G., Carnevali, O., Habibi, H.R., Sanyal, R., Polzonetti-Magni, M.** (2002) Hormonal mechanisms regulating hepatic vitellogenin synthesis in the gilthead sea bream, *Sparus aurata*. *Amer. J. Physiol. Cell Physiol.* 283: C673–C678
- Moutou, K.A., Canario, A.V.M., Mamuris, Z., Power, D.M.** (2001) Molecular cloning and sequence of *Sparus aurata* skeletal myosin light chains expressed in white muscle: developmental expression and thyroid regulation. *J. Exp. Biol.* 204: 3009–3018
- Moutou, K.A., Silva, N., Mamuris, Z., Power, D.M.** (2005) Expression of the myosin light chains 1 and 2 in the developing fast muscle of gilthead sea bream (*Sparus aurata*). *Arch. Tierz. Dummerst.* 48. Special Issue, 75
- Moutoussamy, S., Kelly, P.A., Finidori, J.** (1998) Growth-hormone-receptor and cytokine-receptor-family signaling. *Eur. J. Biochem.* 255(1): 1-11
- Mueller, A.A., Cheung, T.H., Rando, T.A.** (2013) All's well that ends well: alternative polyadenylation and its implications for stem cell biology. *Curr. Opin. Cell Biol.* 25(2): 222-232
- Mugue, N.S., Ozernyuk, N.D.** (2006) Comparative structural analysis of myosin light chains and gene duplication in fish. *Biol. Bull.* 33(1): 30–34
- Muñoz-Cueto, J.A., Martínez-Barberá, J.P., Pendón, C., Rodríguez, R.B., Sarasquete, S.** (1996) Autoradiographic localization of growth hormone binding sites in *Sparus aurata* tissues using a recombinant gilthead seabream growth hormone. *Comp. Biochem. Physiol. Part C: Pharmac. Toxicol. Endocrinol.* 14: 17–22
- Nadjar-Boger, E., Funkenstein, B.** (2011) Myostatin-2 gene structure and polymorphism of the promoter and first intron in the marine fish *Sparus aurata*: evidence for DNA duplications and/or translocations. *BMC Genet.* 12: 22
- Nagalakshmi, U., Wang, Z., Waern, K., Shou, C., Raha, D., Gerstein, M., Snyder, M.** (2008) The transcriptional landscape of the yeast genome defined by RNA sequencing. *Scienc.* 320: 1344–1349
- Near, T.J., Eytan, R.I., Dornburg, A., Kuhn, K.L., Davis, M.P., Wainwright, P.C., Friedman, M., Smith, W.L.** (2012) Resolution of ray-finned fish phylogeny and timing of diversification, *PNAS* 109: 34
- Nei, M., Kumar, S.** (2000) *Molecular Evolution and Phylogenetics*. Oxford University Press, New York
- Nickerson, P.E.B., Myers, T., Clarke, D.B., Chow, R.L.** (2011) Changes in Musashi-1 subcellular localization correlate with cell cycle exit during postnatal retinal development. *Exp. Eye Res.* 92: 344-352
- Nikcevic, G., Perhonen, M., Boateng, S.Y., Russell, B.** (2000) Translation is regulated via the 3' untranslated region of alpha-myosin heavy chain mRNA by calcium but not by its localization. *J. Muscl. Res. Cell Motil.* 21(6): 599-607
- Niessing, D., Dostatni, N., Ja'ckle, H., and Rivera-Pomar, R.** (1999) Sequence interval within the PEST motif of Bicoid is important for translational repression of caudal mRNA in the anterior region of the *Drosophila* embryo. *EMBO J.* 18: 1966–1973
- Nunes, N.M., Li, W., Tian, B., and Furger, A.** (2010) A functional human poly(A) site requires only a potent DSE and an A-rich upstream sequence. *EMBO J.* 29: 1523–1536
- Ohno, S.** (1970) *Evolution by gene duplication*. Springer-Verlag
- On ders, R.J., Mims, S.D., Dasgupta, S.** (2011) Effect of size-grading and feeding frequency on growth and size variation of paddlefish, *Polyodon spathula*, juveniles reared in ponds. *J. Aquacult. Soc.* 42(1): 127-134
- Opazo, J.C., Butts, G.T., Nery, M.F., Storz, J.F., Hoffmann, F.G.** (2012) Whole-genome duplication and the functional diversification of teleost fish hemoglobins. *Mol. Biol. Evol.* 30(1): 140–153

- 
- Ostareck-Lederer, A., Ostareck, D.H., Standart, N., Thiele, B.J.** (1994) Translation of 15-lipoxygenase mRNA is inhibited by a protein that binds to a repeated sequence in the 3' untranslated region. *EMBO J.* 13(6): 1476-1481
- Ostaszewska, T., Dabrowski, K., Wegner, A., Krawiec, M.** (2008) The effects of feeding on muscle growth dynamics and the proliferation of myogenic progenitor cells during pike perch development (*Sander lucioperca*). *J. Aquacult. Societ.* 39(2): 184-195
- Ostbye, T.K., Galloway, T.F., Nielsen, C., Gabestad, I., Bardal, T., Andersen, O.** (2001) The two myostatin genes of Atlantic salmon (*Salmo salar*) are expressed in a variety of tissues. *Europ. J. Biochem.* 268: 5249-5257
- Overton, J.L., Steinfeldt, S.J., Pedersen, P.B.** (2010) The effects of grading on the growth and survival of juvenile Dover sole (*Solea solea* L.). *Aquacult. Res.* 42: 31-39
- Overturf, K., Hardy, R.W.** (2001) Myosin expression levels in trout muscle: a new method for monitoring specific growth rates for rainbow trout *Oncorhynchus mykiss* (Walbaum) on varied planes of nutrition. *Aquacult. Res.* 32: 315-322
- Paillard, L., Omilli, F., Legagneux, V., Bassez, T., Maniey, D., Osborne, H.B.** (1998) EDEN and EDEN-BP, a *cis* element and an associated factor that mediate sequence-specific mRNA deadenylation in *Xenopus* embryos. *EMBO J.* 17(1): 278-287
- Papandroulakis, N., Kentouri, M., Maingot, E., Divanach, P.** (2004) Mesocosm: a reliable technology for larval rearing of *Diplodus puntazzo* and *Diplodus sargus sargus*. *Aquacult. Internat.* 12: 345-355
- Parker, R., Sheth, U.** (2007) P bodies and the control of mRNA translation and degradation. *Mol. Cell.* 25(5): 635-646
- Patterson, S.E., Mook, L.B., Devoto, S.H.** (2008) Growth in the larval zebrafish pectoral fin and trunk musculature. *Dev. Dyn.* 237(2): 307-315.
- Patrino, M., Radaelli, G., Mascarello, F., Carnevali, M.D.C.** (1998) Muscle growth in response to changing demands of functions in the teleost *Sparus aurata* (L.) during development from hatching to juvenile. *Anat. Embryol.* 198: 487-504
- Pavlidis, M., Mylonas, C.C.** (2011) Sparidae. Biology and aquaculture of gilthead seabream and other species. Wiley-Blackwell
- Peng, S.S., Chen, C.Y., Shyu, A.B.** (1996) Functional characterization of a non-AUUUA AU-rich element from the c-jun proto-oncogene mRNA: evidence for a novel class of AU-rich elements. *Mol. Cell Biol.* 16: 1490-1499
- Pérez-Sánchez, J., Martí-Palanca, H., Le Bail, P.-Y.** (1994) Homologous growth hormone (GH) binding in gilthead sea bream (*Sparus aurata*). Effect of fasting and refeeding on hepatic Gh-binding and plasma somatomedin-like immunoreactivity. *J. Fish Biol.* 44: 287-301
- Pérez-Sánchez, J., Martí-Palanca, H., Kaushik, S.J.** (1995) Ration size and protein-intake affect circulating growth-hormone concentration, hepatic growth-hormone binding and plasma insulin-like growth-factor-I immunoreactivity in a marine teleost, the gilthead sea bream (*Sparus aurata*). *J. Nutr.* 125: 546-552
- Pérez-Sánchez, J., Calduch-Giner, J.A., Mingarro, M., Vega-Rubín de Celis, S., Gómez-Requeni, P., Saera-Vila, A., Astola, A. & Valdivia, M.M.** (2002) Overview of fish growth hormone family. New insights in genomic organization and heterogeneity of growth hormone receptors. *Fish Physiol. Biochem.* 27: 243-258
- Perrot, V., Moiseeva, E.B., Gozes, Y., Chan, S.J., Ingleton, P., Funkenstein, B.** (1999) Ontogeny of the insulin-like growth factor system (igf-i, igf-ii, and igf-1r) in gilthead seabream (*Sparus aurata*): expression and cellular localization. *Gener. Comp. Endocrinol.* 116: 445-460
- Pfaffl, M.W., Horgan, G.W., Dempfle, L.** (2002) Relative Expression Software Tool (REST) for group-wise comparison and statistical analysis of relative expression results in real-time PCR. *Nucl. Acids Res.* 30(9): e36
- Pickering, A.D.** (1981) Introduction: The concept of biological stress, in: In: Pickering, A.D. (Eds.), Stress and Fish, Academic Press, pp. 1-9
- Pitkänen, T.I., Xie, S.Q., Krasnov, A., Mason, P.S., Mölsä, H., Stickland, N.C.** (2001) Changes in tissue cellularity are associated with growth enhancement in genetically modified arctic charr (*Salvelinus alpinus* L.) carrying recombinant growth hormone gene. *Mar. Biotechnol.* 3: 188-197
- Popper, D.M., Golden, O., Shezifi, Y.** (1992) Size distribution of juvenile gilthead sea bream (*Sparus aurata*), practical aspects. *Isr. J. Aquacult. Bamidgeh* 44: 147-148
- Postlethwait, J.H., Woods, I.G., Ngo-Hazelett, P., Yan, Y.L., Kelly, P.D., Chu, F., Huang, H., Hill-Force, A., Talbot, W.S.** (2000) Zebrafish comparative genomics and the origins of vertebrate chromosomes. *Genom. Res.* 10: 1890-1902



- 
- Qu, X., Qi, Y., Qi, B.** (2002) Generation of multiple mRNA transcripts from the novel human apoptosis-inducing gene hap by alternative polyadenylation utilization and the translational activation function of 3' untranslated region. *Arch. Biochem. Biophys.* 400: 233–244
- Radaelli, G., Patruno, M., Maccatrozzo, L., Funkenstein, B.** (2003) Expression and cellular localization of insulin-like growth factor-II protein and mRNA in *Sparus aurata* during development. *J. Endocrinol.* 178(2): 285-99
- Ramírez-Zarzosa, G., GiP, F., Latorre, R., Ortega, I.A., Garcia-Alcarfiz, A., Abellfin, E., Vfizquez, J.M., López-Albors, O., Arencibia, A., Moreno, E.** (1995) The larval development of lateral musculature in gilthead sea bream *Sparus aurata* and sea bass *Dicentrarchus labrax*. *Cell Tissue Res.* 280: 217-224
- Rao, P.K., Kumar, R.M., Farkhondeh, M., Baskerville, S., Lodish, H.F.** (2006) Myogenic factors that regulate expression of muscle-specific microRNAs. *Proc. Nat. Acad. Scienc.* 103(23): 8721-8726
- Rayment, I., Holden, H.M., Whittaker, M., Yohn, C.B., Lorenz, M., Holmes, K.C., Milligan, R.A.** (1993) Structure of the actin-myosin complex and its implications for muscle contraction. *Scienc.* 261(5117): 58–65
- Reinecke, M.** (2010) Influences of the environment on the endocrine and paracrine fish growth hormone–insulin-like growth factor-I system. *J. Fish Biol.* 76: 1233–1254
- Reinecke, M., Bjornsson, B. T., Dickhoff, W. W., McCormick, S. D., Navarro, I., Power, D. M., Gutierrez, J.** (2005) Growth hormone and insulin-like growth factors in fish: where we are and where to go. *Gener. Comp. Endocrinol.* 142: 20–24
- Reiser, P.J., Bicer, S.** (2006) Multiple isoforms of myosin light chain 1 in pig diaphragm slow fibers: correlation with maximal shortening velocity and force generation. *Arch. Biochem. Biophys.* 456(2): 112-118
- Rescan, P.Y.** (2008) New insights into skeletal muscle development and growth in teleost fishes. *J. Exp. Zool. Mol. Dev. Evol.* 310B: 541–548
- Rius-Francino, M., Acerete, L., Jiménez-Amilburu, V., Capilla, E., Navarro, I., Gutiérrez, J.** (2011) Differential effects on proliferation of GH and IGFs in sea bream (*Sparus aurata*) cultured myocytes. *Gener. Comp. Endocrinol.* 172: 44–49
- Rodgers, B.D., Weber, G.M., Sullivan, C.V., Levine, M.A.** (2001) Isolation and characterization of myostatin complementary deoxyribonucleic acid clones from two commercially important fish: *Oreochromis mossambicus* and *Morone chrysops*. *Endocrinol.* 142(4): 1412-1418
- Rosenberg, M.I., Georges, S.A., Asawachaicharn, A., Analau, E., Tapscott, S.J.** (2006) MyoD inhibits Fstl1 and Utrn expression by inducing transcription of miR-206. *J. Cell Biol.* 175: 77–85
- Rotter, M., Zimmerman, K., Poustka, A., Soussi-Yanicostas, N., Starzinski-Powitz, A.** (1991) The human embryonic myosin alkali light chain gene: use of alternative promoters and 3' non-coding regions. *Nucl. Acids Res.* 19(7): 1497-1504
- Rotllant, J., Balm, P.H.M., Pérez-Sánchez, J., Wendelaar-Bonga, S.E., Tort, L.** (2001) Pituitary and interrenal function in gilthead sea bream (*Sparus aurata* L., Teleostei) after handling and confinement stress. *Gener. Comp. Endocrinol.* 121: 333–342
- Rowlerson, A., Mascarello, F., Radaelli, G., Veggetti, A.** (1995) Differentiation and growth of muscle in the fish *Sparus aurata* (L) II: Hyperplastic and hypertrophic growth of lateral muscle from hatching to adult. *J. Muscl. Res. Cell Motil.* 16: 223-236
- Rowlerson, A., Veggetti, A.** (2001) Cellular mechanisms of post-embryonic muscle growth in aquaculture species. In *Fish Physiol.* 18: 103–140. Ed. by Johnston I.A., Academic Press
- Russo, T., Costa, C., Cataudella, S.** (2007) Correspondence between shape and feeding habit changes throughout ontogeny of gilthead sea bream *Sparus aurata* L., 1758. *J. Fish Biol.* 71: 629–656
- Sachdev, S., Raychowdhury, M.K., Sarkar, S.** (2003) Human fast skeletal myosin light chain 2 cDNA: isolation, tissue specific expression of the single copy gene, comparative sequence analysis of isoforms and evolutionary relationships. *DNA Seq.* 14(5): 339–350
- Saera-Vila, A., Calduch-Giner, J., Pérez-Sánchez, J.** (2005) Duplication of growth hormone receptor (GHR) in fish genome: gene organization and transcriptional regulation of GHR type I and II in gilthead sea bream (*Sparus aurata*). *Gener. Comp. Endocrinol.* 142: 193–203
- Saera-Vila, A., Calduch-Giner, J., Pérez-Sánchez, J.** (2007) Co-expression of IGFs and GH receptors (GHRs) in gilthead sea bream (*Sparus aurata* L.): sequence analysis of the GHR-flanking region. *J. Endocrinol.* 194: 361–372

**Σφάλμα! Χρησιμοποιήστε την καρτέλα "Κεντρική σελίδα", για να εφαρμόσετε το  
Bibliography στο κείμενο που θέλετε να εμφανίζεται εδώ.**

- Saitou, N., Nei, M.** (1987) The neighbor-joining method: A new method for reconstructing phylogenetic trees. *Mol. Biol. Evol.* 4: 406-425
- Sánchez, A., Robbins, J.** (1994) Unprocessed myogenin transcripts accumulate during mouse embryogenesis. *J. Biol. Chem.* 269(3): 1587-1590
- Sánchez-Ramos, I., Barrios, M., Cross, I., Rebordinos, L.** (2005) Identificación de RFLP en genes relacionados con el crecimiento en dorada *Sparus aurata* L., 1758. *Bolet. Instit. Espan. Ocean.* 21: 253-259
- Sánchez-Ramos, I., Cross, I., Mácha, J., Martínez-Rodríguez, G., Krylov, V., Rebordinos, L.** (2012) Assessment of tools for marker-assisted selection in a marine commercial species: significant association between *mstn-1* gene polymorphism and growth traits. *Scient. World J.*: 369802
- Sangiao-Alvarellos, S., Arjona, F.J., Míguez, J.M., Martín del Río, M.P., Soengas, J.L., Mancera, J.M.** (2006) Growth hormone and prolactin actions on osmoregulation and energy metabolism of gilthead sea bream (*Sparus auratus*). *Comp. Biochem. Physiol., Part A* 144: 491-500
- De Santis, C., Evans, B.S., Smith-Keune, C., Dean, R.J.** (2008) Molecular characterization, tissue expression and sequence variability of the barramundi (*Lates calcarifer*) myostatin gene. *BMC Genom.* 9: 82
- Saoud, I. P., Ghanawi, J., Lebbos, N.** (2007) Effects of stocking density on survival, growth, size variation and condition index of the rabbitfish *Siganus rivulatus*. *Aquacult. Internat.* 16: 109-116
- Sarropoulou, E., Power, D.M., Magoulas, A., Geisler, R., Kotoulas, G.** (2005) Comparative analysis and characterization of expressed sequence tags in gilthead sea bream (*Sparus aurata*) liver and embryos. *Aquacult.* 243: 69-81
- Sarropoulou, E., Power, D.M.P., Mamuris, Z., Moutou, K.A.** (2006) The two isoforms of myosin light chain 2 in gilthead sea bream (*Sparus aurata*); alternative polyadenylation site selection and tissue expression. *Arch. Tierz. Dumm.* 49; Special Issue, 92-96
- Sarropoulou, E., Franch, R., Louro, B., Power, D.M., Bargelloni, L., Magoulas, A., Senger, F., Tsalavouta, M., Patarnello, T., Galibert, F., Kotoulas, G., Geisler, R.** (2007) A gene- based radiation hybrid map of the gilthead sea bream *Sparus aurata* refines and exploits conserved synteny with *Tetraodon nigroviridis*. *BMC Genom.* 8: 44
- Sarropoulou, E., Nousdili, D., Magoulas, A., Kotoulas, G.** (2008) Linking the genomes of nonmodel teleosts through comparative genomics. *Mar. Biotechnol.* 10: 227-233
- Sarropoulou, E., Fernandes, J.MO.** (2011) Comparative genomics in teleost species: Knowledge transfer by linking the genomes of model and non-model fish species. *Comp. Bioch. Biotech.* Part D6: 92-102
- Schwarz, M.H., Delbos, B., Mclean, E., Crais, S.** (2009) Intensive marine finfish larviculture. *Virgin. Cooper. Extens.* publication 600-050
- Senger, F., Priat, C., Hitte, C., Sarropoulou, E., Franch, R., Geisler, R., Bargelloni, L., Power, D., Galibert, F.** (2006) The first radiation hybrid map of a perch-like fish: the gilthead seabream (*Sparus aurata* L). *Genom.* 87: 793-800
- Shalgi, R., Lapidot, M., Shamir, R., Pilpel, Y.** (2005) A catalog of stability-associated sequence elements in 3' UTRs of yeast mRNAs. *Genom. Biol.* 6(10): R86
- Shi, Y., Di Giammartino, D.C., Taylor, D., Sarkeshik, A., Rice, W.J., Yates, J.R., 3rd, Frank, J., Manley, J.L.** (2009) Molecular architecture of the human pre-mRNA 3' processing complex. *Mol. Cell* 33: 365-376
- Shields, R.J.** (2001) Larviculture of marine finfish in Europe. *Aquacult.* 200: 55-88
- Siepel, A., Bejerano, G., Pedersen, J.S., Hinrichs, A.S., Hou, M., Rosenbloom, K., Clawson, H., Spieth, J., Hillier, L.W., Richards, S., Weinstock, G.M., Wilson, R.K., Gibbs, R.A., Kent, W.J., Miller, W., Haussler, D.** (2005) Evolutionarily conserved elements in vertebrate, insect, worm, and yeast genomes. *Genom. Res.* 15(8): 1034-1050
- Silva, P., Power, D.M., Valente, L.M.P., Silva, N., Monteiro, R.A.F., Rocha, E.** (2010) Expression of the myosin light chains 1, 2 and 3 in the muscle of blackspot seabream (*Pagellus bogaraveo*, Brunnich), during development. *Fish Physiol. Biochem.* 36: 1125-1132
- Siomi, H., Siomi, M.C.** (2010) Posttranscriptional regulation of microRNA biogenesis in animals. *Mol. Cell* 38(3): 323-332

**Σφάλμα! Χρησιμοποιήστε την καρτέλα "Κεντρική σελίδα", για να εφαρμόσετε το  
Bibliography στο κείμενο που θέλετε να εμφανίζεται εδώ.**

- Smith, M.E., Fuiman, L.A.** (2003) Causes of growth depensation in red drum, *Sciaenops ocellatus*, larvae. *Environ. Biol. Fish.* 66: 49–60
- Sola, L., Moretti, A., Crosetti, D., Karaiskou, N., Magoulas, A., Rossi, A. R., Rye, M., Triantafyllidis A. and Tsigenopoulos C.S.** (2007) Gilthead seabream—*Sparus aurata*. In genetic effects of domestication, culture and breeding of fish and shellfish, and their impacts on wild population, 47–54. *Genetic impact of aquaculture activities on native population*. Ed. by T. Svasand, D. Crosetti, E. Garcia-Vazquez, E. Verspoor
- Squire, J.M.** (1997) Architecture and function in the muscle sarcomere. *Curr. Opin. Struct. Biol.* 7: 247–257
- Stark, A., Brennecke, J., Bushati, N., Russell, R.B., Cohen, S.M.** (2005) Animal microRNAs confer robustness to gene expression and have a significant impact on 3'UTR evolution. *Cell* 123: 1133–1146
- Stebbins-Boaz, B., Richter, J. D.** (1994) Multiple sequence elements and a maternal mRNA product control cdk2 RNA polyadenylation and translation during early *Xenopus* development. *Mol. Cell Biol.* 14: 5870–5880
- Stefánsson, M.O., Imsland, A.K., Jenssen, M.D., Jonassen, T.M., Stefánsson, S.O., FitzGerald, R.** (2000) The effect of different initial size distributions on the growth of Atlantic halibut. *J. of Fish Biol.* 56: 826–836
- Steinbacher, P., Haslett, J.R., Obermayer, A., Marschallinger, J., Bauer, H.C., Sanger, A.M., Stoiber, W.** (2007) MyoD and myogenin expression during myogenic phases in brown trout: a precocious onset of mosaic hyperplasia is a prerequisite for fast somatic growth. *Dev. Dyn.* 236: 1106–1114
- Steinbacher, P., Haslett, J.R., Six, M., Gollmann, H.P., Sanger, A.M., Stoiber, W.** (2006) Phases of myogenic cell activation and possible role of dermomyotome cells in teleost muscle formation. *Dev. Dyn.* 235: 3132–3143
- Steinke, D., Salzburger, W., Meyer, A.** (2006) Novel relationships among ten fish model species revealed based on a phylogenomic analysis using ESTs. *J. Mol. Evol.* 62: 772–784
- Stellabotte, F., Devoto, S.H.** (2007) The teleost dermomyotome. *Dev. Dyn.* 236: 2432–2443
- Sun, Y., Ge, Y., Drnevich, J., Zhao, Y., Band, M., Chen, J.** (2010) Mammalian target of rapamycin regulates miRNA-1 and follistatin in skeletal myogenesis. *J. Cell Biol.* 189: 1157–1169
- Sunde, L.M., Imsland, A.K., Folkvord, A., Stefánsson, S.O.** (1998) Effects of size grading on growth and survival of juvenile turbot at two temperatures. *Aquacult. Int.* 6: 19–32
- Sweeney, H.L., Stull, J.T.** (1990) Alteration of cross-bridge kinetics by myosin light chain phosphorylation in rabbit skeletal muscle: implications for regulation of actin-myosin interaction. *Proc. Nat. Acad. Sci.* A87(1): 414–418
- Sweeney, H.L., Bowman, B.F., Stull, J.T.** (1993) Myosin light chain phosphorylation in vertebrate striated muscle: regulation and function. *Am. J. Physiol. Cell Physiol.* 264: C1085–C1095
- Szczesna, D., Zhao, J., Jones, M., Zhi, G., Stull, J., Potter, J.D.** (2002) Phosphorylation of the regulatory light chains of myosin affects Ca<sup>2+</sup> sensitivity of skeletal muscle contraction. *J. Appl. Physiol.* 92: 1661–1670
- Tamura, K., Peterson, D., Peterson, N., Stecher, G., Nei, M., Kumar, S.** (2011) MEGA5: Molecular evolutionary genetics analysis using maximum likelihood, evolutionary distance, and maximum parsimony methods. *Mol. Biol. Evol.* 28(10): 2731–2739
- Tan, X., Du, S.J.** (2002) Differential expression of two MyoD genes in fast and slow muscles of gilthead seabream (*Sparus aurata*). *Dev. Genes Evol.* 212(5): 207–217
- Tapscott, S.J.** (2005) The circuitry of a master switch: MyoD and the regulation of skeletal muscle gene transcription. *Dev.* 132: 2685–2695
- Taulli, R., Bersani, F., Foglizzo, V., Linari, A., Vigna, E., et al.** (2009) The muscle-specific microRNA miR-206 blocks human rhabdomyosarcoma growth in xenotransplanted mice by promoting myogenic differentiation. *J. Clin. Invest.* 119: 2366–2378
- Tekotte, H., Davis, I.** (2002) Intracellular mRNA localization: motors move messages. *Trends Genet.* 18: 636–642
- Teles, M., Boltaña, S., Reyes-López, F., Santos, M.A., Mackenzie, S., Tort, L.** (2013) Effects of chronic cortisol administration of GR and the liver transcriptome in *Sparus aurata*. *Mar. Biotechnol.* 15: 104 – 114

- 
- Thompson, J.D., Higgins, D.G., Gibson, T.J., Clustal, W.** (1994) Improving the sensitivity of progressive multiple sequence alignment through sequence weighting, position-specific gap penalties and weight matrix choice. *Nucl. Acids Res.* 22(22): 4673-4680
- Thomsen, S., Anders, S., Janga, S.C., Huber, W., Alonso, C.R.** (2010) Genome-wide analysis of mRNA decay patterns during early *Drosophila* development. *Genom. Biol.* 11: R93
- Tiago, D.M., Laizé, V., Cancela M.L.** (2008) Alternatively spliced transcripts of *Sparus aurata* insulin-like growth factor 1 are differentially expressed in adult tissues and during early development. *Gener. Comp. Endocrinol.* 157: 107-115
- Tian, B., Hu, J., Zhang, H., and Lutz, C.S.** (2005) A large-scale analysis of mRNA polyadenylation of human and mouse genes. *Nucl. Acids Res.* 33: 201-212
- Topisirovic, I., Siddiqui, N., Orolicki, S., Skrabanek, L.A., Tremblay, M., Hoang, T., Borden, K.L.** (2009) Stability of eukaryotic translation initiation factor 4E mRNA is regulated by HuR, and this activity is dysregulated in cancer. *Mol. Cell Biol. Mar.* 29(5): 1152-1162
- Tranter, M., Helsley, R.N., Paulding, W.R., McGuinness, M., Brokamp, C., Haar, L., Liu, Y., Ren, X., Jones, W.K.** (2011) Coordinated post-transcriptional regulation of hsp70.3 gene expression by microRNA and alternative polyadenylation. *J. Biol. Chem.* 286(34): 29828-29837
- Tucker, M., Staples, R.R., Valencia-Sanchez, M.A., Muhrad, D., Parker, R.** (2002) Ccr4p is the catalytic subunit of a Ccr4p/Pop2p/Notp mRNA deadenylase complex in *Saccharomyces cerevisiae*. *EMBO J.* 21(6): 1427-1436
- Ulitsky, I., Shkumatava, A., Jan, C., Subtelny, A.O., Koppstein, D., Bell, G., Sive, H., Bartel, D.** (2012) Extensive alternative polyadenylation during zebrafish development. *Genom. Res.* 22: 2054-2066
- Uribe, C., Folch, H., Enriquez, R., Moran, G.** (2011) Innate and adaptive immunity in teleost fish: a Review *Veterin. Medic.* 56(10): 486-503
- Valente, L.M.P., Rocha, E., Gomes, E.F.S., Silva, M.W., Oliveira, M.H., Monteiro, R.A.F., Fauconneau, B.** (1999) Growth dynamics of white and red muscle fibres in fast- and slow-growing strains of rainbow trout. *J. Fish Biol.* 55: 675-691
- Valente, L.M.P., Cornet, J., Donnay-Moreno, C., Gouygou, J.P., Bergé, J.P., Bacelar, M., Escórcio, C., Rocha, E., Malhão, F., Cardinal, M.** (2011) Quality differences of gilthead sea bream from distinct production systems in Southern Europe: Intensive, integrated, semi-intensive or extensive systems. *Food Contr.* 22: 708-717
- Valente, L.M.P., Moutou, K.A., Conceição, L.E.C., Engrola, S., Fernandes, J.M.O., Johnston, I.A.** (2013) What determines growth potential and juvenile quality of farmed fish species? *Rev. Aquacult.* 5(1): S168-S193
- Vandesompele, J., De Preter, K., Pattyn, F., Poppe, B., Van Roy, N., De Paepe, A., Speleman, F.** (2002) Accurate normalization of real-time quantitative RT-PCR data by geometric averaging of multiple internal control genes. *Genom. Biol.* 3(7): research0034.1
- Vargas-Chacoff, L., Astola, A., Arjona, F.J., Martín del Río, M.P., García-Cózar, F., Mancera, J.M. & Martínez-Rodríguez, G.** (2009) Gene and protein expression for prolactin, growth hormone and somatolactin in *Sparus aurata*: Seasonal variations. *Comp. Biochem. Physiol. Part B*, 153: 130-135
- Veggetti, A., Mascarello, F., Scapolo, P.A., Rowlerson, A., Candia Carnevali, M.D.** (1993) Muscle growth and myosin isoform transitions during development of a small teleost fish, *Poecilia reticulata* (Peters) (Atheriniformes, Poeciliidae): a histochemical, immunohistochemical, ultrastructural and morphometric study. *Anat. Embryol.* 187: 353-361
- Velloso, C.P.** (2008) Regulation of muscle mass by growth hormone and IGF-I. *Br. J. Pharmacol.* 154(3): 557-568
- Venuti, J.M., Morris, J.H., Vivian, J.L., Olson, E.N., Klein, W.H.** (1995) Myogenin is required for late but not early aspects of myogenesis during mouse development. *J. Cell Biol.* 128(4): 563-576
- Vicente-Manzanares, M., Ma, X., Adelstein, R.S., Horwitz, A.R.** (2009) Non-muscle myosin II takes centre stage in cell adhesion and migration. *Nat. Rev. Mol. Cell Biol.* 10(11): 778-790
- Vieira, F.A., Gregório, S.F., Ferrareso, S., Thorne, M.A.S., Costa, R., Milan, M., Bargelloni, L., Clark, M.S., Canario, A.V.M., Power, D.M.** (2011) Skin healing and scale regeneration in fed and unfed sea bream *Sparus auratus*. *BMC Genom.* 12: 490

**Σφάλμα! Χρησιμοποιήστε την καρτέλα "Κεντρική σελίδα", για να εφαρμόσετε το**

**Bibliography στο κείμενο που θέλετε να εμφανίζεται εδώ.**

- 
- Vilela, C., Ramirez, C.V., Linz, B., Rodrigues-Pousada, C., McCarthy, J.E. (1999) Post-termination ribosome interactions with the 5' UTR modulate yeast mRNA stability. *EMBO J.* 18: 3139-3152
- Vlasova, I.A., Tahoe, N.M., Fan, D., Larsson, O., Rattenbacher, B., Sternjohn, J.R., Vasdewani, J., Karypis, G., Reilly, C.S., Bitterman, P.B., Bohjanen, P.R. (2008) Conserved GU-rich elements mediate mRNA decay by binding to CUG-binding protein 1. *Mol. Cell* 29: 263-270
- Volff, J.N. (2005) Genome evolution and biodiversity in teleost fish. *Hered.* 94(3): 280-294
- Wallace, J.C., Kolbeinshavn, A.G. (1988) The effect of size grading on subsequent growth in fingerling Arctic charr, *Salvelinus alpinus*. *Aquacult.* 73: 97-100
- Wallat, G.K., Tiu, L.G., Wang, H.P., Rapp, D., Leighfield, C. (2005) The effects of size grading on production efficiency and growth performance of yellow perch in earthen ponds. *North Amer. J. Aquacult.* 67: 34-41
- Wang, Y., Liu, C.L., Storey, J.D., Tibshirani, R.J., Herschlag, D., Brown, P.O. (2002) Precision and functional specificity in mRNA decay. *Proc. Nat. Acad. Scienc.* 99(9): 5860-5865
- Wang, Y., Szczesna-Cordary, D., Craig, R., Diaz-Perez, Z., Guzman, G., Miller, T., Potter, J.D. (2007) Fast skeletal muscle regulatory light chain is required for fast and slow skeletal muscle development. *FASEB J.* 21(9): 2205-2214
- Wang, E.T., Sandberg, R., Luo, S., Khrebtkova, I., Zhang, L., Mayr, C., Kingsmore, S.F., Schroth, G.P., Burge, C.B. (2008) Alternative isoform regulation in human tissue transcriptomes. *Nat.* 456(7221): 470-476
- Weatherly, A.H., Gill, H.S., Lobo, A.F. (1988) Recruitment and maximal diameter of axial muscle fibres in teleosts and their relationship to somatic growth and ultimate size. *J. Fish Biol.* 33: 851-859
- Weeds, A. G., Lowey, S. (1971) Substructure of the myosin molecule. II. The light chains of myosin. *J. Mol. Biol.* 61: 701-725
- Weintraub, H., Tapscott, S.J., Davis, R.L., Thayer, M.J., Adam, M.A., Lassar, A.B., Miller, A.D. (1989) Activation of muscle-specific genes in pigment, nerve, fat, liver, and fibroblast cell lines by forced expression of MyoD. *Proc. Nat. Acad. Scienc.* 86(14): 5434-5438
- Weintraub, H., Davis, R., Tapscott, S., Thayer, M., Krause, M., Benezra, R., Blackwell, T.K., Turner, D., Rupp, R., Hollenberg, S. (1991) The myoD gene family: nodal point during specification of the muscle cell lineage. *Scienc.* 251(4995): 761-766
- Wharton, R.P., Struhl, G. (1991) RNA Regulatory elements mediate control of *Drosophila* body pattern by the posterior morphogen nanos. *Cell* 67: 955-967
- Whalen, R.G., Sell, S.M., Butler-Browne, G.S., Schwartz, K., Bouveret, P., Pinset-Harstrom, I. (1981) Three myosin heavy chain isozymes appear sequentially in rat muscle development. *Natur.* 292: 805-809
- Wheelan, S.J., Church, D.M., Ostell, J.M. (2001) Spidey: a tool for mRNA-to-genomic alignments. *Genom. Res.* 11: 1952-1957
- Wightman, B., Ha, I., Ruvkun, G. (1993) Posttranscriptional regulation of the heterochronic gene *lin-14* by *lin-4* mediates temporal pattern formation in *C. elegans*. *Cell* 75: 855-862
- Wilkes, D., Xie, S.Q., Stickland, N.C., Alami-Durante, H., Kentouri, M., Steriotti, A., Koumoundouros, G., Fauconneau, B., Goldspink, G. (2001) Temperature and myogenic factors transcript levels during early development determines muscle growth potential in rainbow trout (*Oncorhynchus mykiss*) and sea bass (*Dicentrarchus labrax*). *J. Exp. Biol.* 204: 2763-2771
- Wiseman, J.W., Glover, L.A., Hesketh, J.E. (1997) Evidence for a localization signal in the 3' untranslated region of myosin heavy chain messenger RNA. *Cell Biol. Int.* 21: 243-248
- Wood, A.W., Duan, C., Bern, H.A. (2005) Insulin-like growth factor signaling in fish. *Int. Rev. Cytol.* 243: 215-285
- Wreden, C., Verrotti, A.C., Schisa, J.A., Lieberfarb, M.E., Strickland, S. (1997) Nanos and pumilio establish embryonic polarity in *Drosophila* by promoting posterior deadenylation of hunchback mRNA. *Dev.* 124: 3015-3023
- Wright, W.E., Binder, M., Funk, W. (1991) Cyclic amplification and selection of targets (CASTing) for the myogenin consensus binding site. *Mol. Cell. Biol.* 11: 4104 - 4110

**Σφάλμα! Χρησιμοποιήστε την καρτέλα "Κεντρική σελίδα", για να εφαρμόσετε το**

**Bibliography στο κείμενο που θέλετε να εμφανίζεται εδώ.**

- 
- Xie, S.Q., Mason, P., Wilkes, D., Goldspink, G., Fauconneau, B., Stickland, N.C.** (2001) Lower environmental temperature delays and prolongs myogenic regulatory factor expression and muscle differentiation in rainbow trout (*Oncorhynchus mykiss*) embryos. *Differentiat.* 68: 106–114
- Yada, T., Nagae, M., Moriyama, S., Azuma, T.** (1999) Effects of prolactin and growth hormone on plasma immunoglobulin M levels of hypophysectomized rainbow trout, *Oncorhynchus mykiss*, *Gener. Comp. Endocrinol.* 115: 46–52
- Yamano, K., Takano-Ohmuro, H., Obinata, T., Inui, Y.** (1994) Effect of thyroid hormone on developmental transition of myosin light chain during flounder metamorphosis. *Gener. Comp. Endocrinol.* 93: 321–326
- Yan, D., Dong, X.E., Chen, X., Wang, L., Lu, C., et al.** (2009) MicroRNA-1/206 targets c-Met and inhibits rhabdomyosarcoma development. *J. Biol. Chem.* 284: 29596–29604
- Yan, X., Ding, L., Li, Y., Zhang, X., Liang, Y., Sun, X., Teng, C.** (2012) Identification and profiling of microRNAs from skeletal muscle of the common carp. *PLOS One* 7(1): e30925
- Yang, Z., Sweeney, H.L.** (1995) Restoration of phosphorylation-dependent regulation to the skeletal muscle myosin regulatory light chain. *J. Biol. Chem.* 270(42): 24646–24649
- Yúfera, M., Halm, S., Beltran, S., Fusté, B., Planas, J.V., Martínez-Rodríguez, G.** (2012) Transcriptomic characterization of the larval stage in gilthead seabream (*Sparus aurata*) by 454 pyrosequencing. *Mar. Biotechnol.* 14: 423 – 435
- Zakeš, Z., Kowalska, A., Czerniak, S.** (2004) Effect of sorting on selected rearing factors of pikeperch *Sander lucioperca* (L). *Arch. Polish Fish.* 12: 71–79
- Zar, J.H.** (1996) *Biostatistical analysis*. 3rd Ed., Prentice-Hall
- Zarudnaya, M.I., Kolomiets, I.M., Potyahaylo, A.I., Hovorun, D.M.** (2003) Downstream elements of mammalian pre-mRNA polyadenylation signals: primary, secondary and higher-order structures. *Nucl. Acid. Res.* 31(5): 1375–1386
- Zhang, W., Behringer, R.R., Olson, E.N.** (1995) Inactivation of the myogenic bHLH gene MRF4 results in up-regulation of myogenin and rib anomalies. *Genes Dev.* 9: 1388–1399
- Zhu, Z.** (1992) Generation of fast growing transgenic fish: methods and mechanisms. In *Transgenic Fish*, Ed. by C.L. Hew, G.L. Fletcher, 92–119. World Scientific Publishing
- Zohar, Y., Abraham, M., Gordin, H.** (1978) The gonadal cycle of the captivity-reared hermaphroditic teleost *Sparus aurata* (L.) during the first two years of life. *Ann. Biol. Anim. Biochem. Biophys.* 18: 877–882
- Zohar, Y., Billard, R., Weil, C.** (1984) La reproduction de la daurade (*Sparus aurata*) et du bar (*Dicentrarchus labrax*): Connaissance du cycle sexual et controle de la gametogenese et de la ponte. In *Biological Citation, L'Aquaculture DuBar-Et-Des-Sparides*. Ed. by Barnabe, G., Billard, R., 3–24
- Zouiten, D., Khemis, I.B., Masmoudi, A.S., Huelvan, C., Cahu, C.** (2011) Comparison of growth, digestive system maturation and skeletal development in sea bass larvae reared in an intensive or a mesocosm system. *Aquacult. Res.* 42: 1723–1736
- Zuker, M.** (2003) Mfold web server for nucleic acid folding and hybridization prediction. *Nucl. Acids Res.* 31: 3406–3415

References

*Σφάλμα! Χρησιμοποιήστε την καρτέλα "Κεντρική σελίδα", για να εφαρμόσετε το  
Bibliography στο κείμενο που θέλετε να εμφανίζεται εδώ.*

---

---

**ANNEX I - Abbreviations List**

aa:	aminoacids
AREs:	AU-rich elements
ATP:	Adenosine-5'-triphosphate
bHLH:	basic helix-loop-helix
BAC:	bacterial artificial chromosomes
BW:	body weight
cDNA:	complementary DNA
CHO:	Chinese hamster ovary cell line
COL1a:	collagen 1a
CPE:	cytoplasmic polyadenylation element
CPEB:	cytoplasmic polyadenylation element binding protein
CPSF:	Cleavage and Polyadenylation Specificity Factor
CstF:	Cleavage Stimulation Factor
dph:	days post hatch
EF1a:	elongation factor 1a
ESTs:	expressed sequence tags
i.p.:	intraperitoneal
FST:	follistatin
GH:	growth hormone
GHR:	growth hormone receptor
hpf:	hours post fertilization
IGFI:	insulin-like growth factor 1
LG:	linkage group
luc:	luciferase
MBE:	Mushasi binding element
MEF-2:	myocyte enhancer factor-2
MHC:	myosin heavy chain
miRNA:	<i>microRNA</i>
MLC2:	myosin light chain 2
MLC2A:	myosin light chain 2 isoform A
MLC2B:	myosin light chain 2 isoform B
MLCK:	myosin light chain kinase
MPCs:	myogenic progenitor cells
MRFs:	myogenic regulator factors



mRNA:	messenger ribonucleic acid
mstn:	myostatin
MYOG:	myogenin
poly(A) signal:	polyadenylation signal
RH map:	radiation hybrid map
RPS18:	ribosomal protein S18
RPL13a:	ribosomal protein L13a
SGR:	somatic growth rate
SNPs:	single nucleotide polymorphisms
TNF:	total number of fibers
ORF:	open reading frame
uORF:	upstream open reading frame
UTR:	untranslated region
WGD:	whole genome duplication